

**2 0 1 0**  

---

**DEFENSE**  
**WHITE PAPER**  

---



## Message from the Minister of National Defense

---

The year 2010 marked the 60<sup>th</sup> anniversary of the outbreak of the Korean War. Since the end of the war, the Republic of Korea has made such great strides and its economy now ranks among the 10-plus largest economies in the world. Out of the ashes of the war, it has risen from an aid recipient to a donor nation. Korea's economic miracle rests on the strength and commitment of the ROK military.

However, the threat of war and persistent security concerns remain undiminished on the Korean Peninsula. North Korea is threatening peace with its recent surprise attack against the ROK Ship *Cheonan* and its firing of artillery at Yeonpyeong Island. The series of illegitimate armed provocations by the North have left a fragile peace on the Korean Peninsula.

Transnational and non-military threats coupled with potential conflicts among Northeast Asian countries add another element that further jeopardizes the Korean Peninsula's security.

To handle security threats, the ROK military has instituted its Defense Vision to foster an 'Advanced Elite Military,' which will realize the said Vision. As part of the efforts, the ROK military complemented the Defense Reform Basic Plan and has revamped its weapon procurement and acquisition system. In addition, it has revamped the educational system for officers while strengthening the current training system by extending the basic training period and by taking other measures. The military has also endeavored to invigorate the defense industry as an exporter so the defense economy may develop as a new growth engine for the entire Korean economy. To reduce any possible inconveniences that Koreans may experience, the military has reformed its defense rules and regulations to ease the standards necessary to designate a Military Installation Protection Zone.

Considering the current strategic environment, we reached an agreement to adjust the date of Wartime OPCON (Operational Control) transition with the U.S. In addition, we succeeded in holding the first ever ROK-U.S. Foreign and Defense Ministers' Meeting, which is a testament to both nations' dedication to have a strong alliance. At the Meeting, the two nations agreed to sustain and further develop a future-oriented strategic alliance. The 42<sup>nd</sup> ROK-U.S. Security Consultative Meeting (SCM) held in 2010 resulted in critical agreements concerning the Strategic Alliance 2015, the Guidelines for ROK-U.S. Defense Cooperation, and the Strategic Planning Guidance (SPG). The ROK's overseas troops, including the *Dongmyeong* Unit in Lebanon, the *Cheonghae* Unit in the Gulf of Aden, the *Danbi* Unit in Haiti and the *Ashena* Unit in Afghanistan, have contributed to world peace through successful local operations.

However, further reform remains to be achieved in many areas. The ROK Ship *Cheonan* incident and the North's provocative artillery firing at Yeonpyeong Island brought dishonor and indelible scars to the ROK military. Furthermore, these incidents caused many Koreans to question the ROK military's immediate response to these threats.

---

The ROK military will continue its commitment to a high readiness posture to exact swift, immediate punishment against the North for any provocative act it may seek to perpetrate. In addition, we will set conditions that only allows for a military that is respected by its combat skills and operational results through the elimination unnecessary administrative elements, bureaucratic cultures, and mannerism prevailing throughout all corners of National Defense. Also, we intend to equip a 'Combat Oriented Military' armed with highly proficient warfighting capabilities, and a 'Warrior of Warriors Ideal' filled with the willingness to fight in a well disciplined manner.

We will upgrade our combat capabilities that set forth conditions suitable for effectively executing Network Centric Warfare (NCW), and will establish an advanced warfighting system that practically indoctrinates jointness across the services in any impending situations.

Within the framework of the Strategic Alliance 2015, we will closely cooperate with the U.S. on major issues between the two countries, while endeavoring to achieve a stable and sustainable ROK-U.S. alliance. We will also involve ourselves in military diplomacy and Peacekeeping Operations (PKO) as part of the efforts to lift the nation's prominence and increase national interest. Moreover, the ROK military will take a leading role in accomplishing 'a Fair Society' moving toward 'a Greater Korea,' which is the core policy slogan of the ROK Government.

The *Defense White Paper 2010* will discuss the defense policy directions designed to realize the National Security Strategy (NSS), while providing up-to-date and candid information about the progress and plans of the policies. This Defense White Paper will also deal with major defense issues in great detail, with appendices on defense-related data, including a memoir of the Korean War, the North's attack against the ROK Ship Cheonan and the North's firing of artillery at Yeonpyeong Island.

We hope that the *Defense White Paper 2010* will deftly guide you through the ROK military's moves as a peace keeper on the Korean Peninsula, in the Asia-Pacific region and in the entire world. From this time forward, the ROK military will try with utmost sincerity to establish 'a strong military capable of gaining victory in any immediate skirmishes' by 'reshaping itself for victory.' We look forward to the continued attention and support of Korean readers.

December 31, 2010



Kim, Kwan Jin

Minister of National Defense, Republic of Korea

# Contents

## Chapter 1

Changes in the Security Environment and Challenges Ahead

Section 1. Global Security Landscape	8
Section 2. Security Landscape in Northeast Asia	13
Section 3. North Korean Situation and Military Threat	24

## Chapter 2

National Security Strategy and Defense Policy

Section 1. National Security Strategic Guidance	38
Section 2. Objectives and Tenets of the National Defense Policy	41

## Chapter 3

Defense Posture for Comprehensive Security

Section 1. All-Directional Military Readiness Posture	50
Section 2. Integrated Civilian-Government-Military-Police Defense Posture	63
Section 3. Development of a Readiness Posture against Transnational and Non-military Threats	69

## Chapter 4

The Development of the ROK-U.S. Military Alliance and Expansion of Defense Diplomacy and Cooperation

Section 1. The Development of a Future-oriented ROK-U.S. Military Alliance	76
Section 2. Adjustment of the Timing for the Wartime OPCON Transition and Building a New Alliance Military Structure	80
Section 3. Ensuring Secure Stationing Conditions for the United States Forces in Korea (USFK)	87
Section 4. Expanding the Boundaries of Defense Diplomacy and Cooperation	92
Section 5. Contributions to International Peacekeeping Operations	106

## Chapter 5

Military Support to Advance Inter-Korean Relations

Section 1. Inter-Korean Military Confidence Building and Arms Control	118
Section 2. Repatriation of ROK POWs and Joint Remains Recovery	127



## Chapter 6

### Establishing Advanced Military Capabilities

Section 1. National Defense Reform to Build Advanced Elite Military Forces	134
Section 2. Streamlining the Military Structure	138
Section 3. Improving the Force Structure	144
Section 4. Building Up Strong Reserve Forces	149
Section 5. Establishing a Network-Centric Defense Informatization Environment	158

## Chapter 7

### Improving the Cultivation, Educational and Training Systems for Defense Personnel

Section 1. Developing Defense Personnel Operations and Management System	168
Section 2. Realignment of the Mental Strength Education System	181
Section 3. Cultivating Strong Warriors by Concentrating Efforts on Training and Education	184
Section 4. Improving the Educational System for Officers to Boost Jointness and Efficiency	198

## Chapter 8

### Enhancement of Management Efficiency

Section 1. Enhancing the Efficiency of National Defense Resource Management	202
Section 2. Optimizing Defense Resources through the Use of Public and Private Resources	213
Section 3. Improving the Procurement and Acquisition System of Weapons	217
Section 4. Developing the Defense Economy into a Growth Engine for the National Economy	221

## Chapter 9

### Attractive Military, Rewarding Military

Section 1. Improving the Welfare of Service Members	238
Section 2. Modernizing the Military Facilities	252
Section 3. Advancing the Military Medical Service System	256
Section 4. Invigorating Productive Military Service Conditions	259

## Chapter 10

### The Armed Forces Serving the People

Section 1. Enhancing Public Benefit and Protecting Public Rights	266
Section 2. Efficient Relocation of Military Installations	281
Section 3. National Defense Policy That Goes Together With the People	285

## Appendix

### Special Appendix ..... 304

1. Recollections about the Korean War
2. North Korea's Infiltrations and Provocations against South Korea and Naval Campaigns at the Northern Limit Line (NLL)
3. Attack Against ROKS Cheonan
4. Artillery Firing at Yeonpyeongdo (Island)

### Appendix ..... 337

1. Status of Neighboring Countries' Military Strength
2. Comparison between Major Countries' Defense Budgets
3. Comparison of the Military Strength of the Two Koreas
4. Comparison of the Economic Indicators of the Two Koreas
5. Negotiation Process in North Korea's Nuclear Program
6. History of North Korea's Missile Development Program and Specifications
7. Chronology of South-North Military Talks
8. Chronicle of Inter-Korean Relations
9. Status of UN Peacekeeping Operations
10. Budget for ROK military units dispatched overseas
11. Status of Dispatch of ROK Troops Overseas
12. Status of Countries Participating in the International Security Assistance Force (ISAF)
13. The Act on Participation in UN Peacekeeping Operations
14. Joint Communiqué of The 41<sup>st</sup> ROK-U.S. Security Consultative Meeting
15. Joint Communiqué of The 42<sup>nd</sup> U.S.-ROK Security Consultative Meeting
16. The Guidelines for ROK-U.S. Defense Cooperation
17. Joint Statement of ROK-U.S. Foreign and Defense Ministers' Meeting on the Occasion of the 60<sup>th</sup> Anniversary of the Outbreak of the Korean War
18. Major Arms Control Conventions and Organizations
19. National Defense Organizations
20. Annual Defense Budgets
21. Defense Industrial Cooperation Agreements with Other Countries
22. Changes in Compulsory Military Service Period
23. Alternatives to Military Service
24. Combined/Joint Military Exercises and Training
25. Composition and Major Activities of National Assembly Defense Committee
26. Revision Details of Laws and Ordinances Related to the Ministry of National Defense (MND)



Nuc  
Sec  
Sum  
Washing

Nuc  
Sec  
Sum  
Washing

The First Nuclear Security Summit (Washington D.C., April 2010)

clear  
urity  
mit  
gton, 2010

lear  
urity  
mit  
gton, 2010

# Chapter 1

## Changes in the Security Environment and Challenges Ahead

Section 1. Global Security Landscape

Section 2. Security Landscape in Northeast Asia

Section 3. North Korean Situation and Military Threat

# Section 1

## Global Security Landscape

Besides the persisting conventional military threats, today's global security environment is also characterized by concerns over increased transnational and non-military threats, including the proliferation of weapons of mass destruction (WMD), terrorism, piracy at sea, and natural disasters. To make matters worse, security threats have become more complicated and multifarious involving disputes and conflicts pertaining to territories, resources, religions, and races. Faced with this new security environment, countries around the world have endeavored to maximize their national interests by strengthening their security capabilities at the comprehensive level and cooperating strategically with other nations while at the same time keeping them in check.

### 1. Changes in Security Threats

In addition to the traditional military threats, the nature of today's changing security threats can be summed up as being complicated and multifarious due to the increase of transnational and non-military threats. Borderless threats that encompass the proliferation of weapons of mass destruction (WMDs), terrorism, piracy at sea and cyber attacks have been continually increasing, while non-military threats, including communicable diseases, natural disasters, global warming, and environmental pollution have also emerged as major security issues.

Multifaceted local conflicts caused by a combination of factors, e.g., territorial and resource disputes, religious and racial conflicts, and separatist and independence movements continue to plague the world, although the likelihood of a large scale war has diminished in this post-Cold War era. For instance, the Israel-Lebanon War in the Middle East ended in August 2006, but the seeds of dispute remain unabated. In the conflict between

Locations of the Major Areas of Conflict





Israel and Palestine, the international efforts to mediate the dispute have failed to narrow the distance between the two countries, in which the issues remain unresolved. Iraq continues to be unstable because terrorism could spread in the country. In Europe, war between Russia and Georgia broke out in August 2008 over the separatist regions Abkhazia and South Ossetia. The war came to an end relatively quickly thanks to the European Union's efforts as a mediator but tensions still remain. Also in Africa, conflicts in Sudan, Somalia and Chad have yet to be resolved.

In the proliferation of WMDs, which include nuclear, biological, and chemical weapons, and their delivery vehicles, ballistic missiles present a primary threat to global security. They are particularly damaging to global security since some countries spur the development of the technology for nuclear weapons and long-range missiles, and thus the parts and materials for those WMDs are easily acquired through the international black market. Biochemical weapons, such as anthrax and sarin gas, are feared to be easily manufactured at low cost, allowing terrorist groups to procure those weapons quite easily.

Since the 9/11 attacks, terrorism has posed a major threat to the global security environment. Furthermore, globalization and advances in information technology have given international terrorist organizations the means of acquiring weapons. Moreover, unlike regular military units, they are organized as in the manner of a distributed network that spans borders and nations, which makes it difficult to tackle their activities and prevent their attacks. Terrorist organizations are dispersed across the globe, and they have no constituents of their own to protect. Once nuclear weapons fall into their hands, it is highly likely that they would use them. Thus, terrorist threats have surfaced as a prime security issue internationally.

Piracy at sea is also a key security issue threatening the safety of the sea lanes. According to statistics released by the International Maritime Bureau (IMB),<sup>1</sup> a total of 406 cases of piracy in the world were reported in 2009 alone, representing a 39% increase over the 293 cases reported in the previous year. Of these, pirates off the coast of Somalia accounted for 217 cases or 53% of the total.

**1. International Maritime Bureau (IMB)**  
A specialized agency of the International Chamber of Commerce. The IMB was established in 1981 to act as the focal point in the fight against all types of maritime crime and malpractice, including piracy.

As information and communications technologies have advanced, cyber terror and attacks have been on the rise, and each nation is struggling to defend against them. Considering that attacks in cyber space target not only individuals or companies but also governments, proper countermeasures at the governmental level are essential to ensure national security.

Communicable diseases, including SARS and the H1N1 virus, are spreading around the world. At the same time, mega-class natural disasters, such as the earthquakes in Haiti and Chile, have also emerged as new security threats. To meet these challenges requires joint international efforts.

The recent competition between nations to secure energy resources has become a new factor in shaping the world order. Consequently, the major powers have been vying with one another for new energy sources in Central Asia, South America, Africa, and the Caspian Sea, thus attributing to destabilizing the security conditions in these regions.

## **2. International Efforts for Peace and Stability**

As potential global security threats become increasingly complex and diverse, new countermeasures are required. Considering the transnational and non-military nature of some threats, a countermeasure employed by a single country has limitations. In this regard, collaboration between allies and like-minded countries, as well as joint efforts by the international community, cannot be overemphasized. Indeed, comprehensive countermeasures are vital through non-military approaches, including diplomacy, judicial reviews, information, and the economy, rather than through military-oriented responses. Further, when the culprit behind the 9/11 attacks was shown to be an international terrorist network, the importance of a joint international effort was given great weight in preventing terrorist attacks and the proliferation of WMDs. Accordingly, international cooperation has been increasingly reinforced in such areas as information exchange, freezing of assets, criminal investigations, and search for and extradition of terrorists.

International conventions and organizations spearhead activities to

prevent the proliferation of WMDs. These international conventions include the Nuclear Non-Proliferation Treaty (NPT), the Chemical Weapons Convention (CWC), the Biological Weapons Convention (BWC), and the Hague Code of Conduct Against Ballistic Missile Proliferation (HCOG). The International Atomic Energy Agency (IAEA) is one such international organization focusing on these issues. In addition, the United States has stepped up its efforts to prevent the proliferation of WMDs, which could be used in international terrorist activities, by launching the Proliferation Security Initiative (PSI).<sup>2</sup> The ROK Government also officially joined the PSI in May 2009. As of August 2010, a total of 98 countries were participating in the international Initiative.

Together with the efforts to prevent the proliferation of WMDs, the international community is striving for nuclear weapons reduction. As a follow-up to the ‘Strategic Arms Reduction Treaty’ (START I),<sup>3</sup> the ‘New Strategic Arms Reduction Treaty’ (New START)<sup>4</sup> was signed by the United States and Russia in August 2010. Further, in April 2010, to set up an international (arms control) regime to prevent nuclear terrorism, the ‘Nuclear Security Summit’ was held in Washington, D.C. for the first time and was attended by 47 heads of states. At the Summit, these leaders adopted a joint communiqué consisting of twelve items, and the ROK



President Lee Myung-bak participating in the first Nuclear Security Summit (Washington D.C., April 2010)

## 2. Proliferation Security Initiative (PSI)

To prevent the proliferation of WMDs and the materials necessary for their delivery, the PSI was initiated by the U.S. and eleven major European and Asian countries, as founding members, in June 2003.

## 3. Strategic Arms Reduction Treaty (START I)

START I is a bilateral treaty that was signed in 1991 by the United States and the USSR to reduce and limit their strategic weapons, including nuclear warheads and their delivery vehicles, missiles.

## 4. New Strategic Arms Reduction Treaty (New START)

New START was signed by the U.S. and Russia to replace the Strategic Arms Reduction Treaty as START I, which sought to reduce the number of strategic weapons held by the two nations, expired in December 2009. New START has a new reduction target (valid for ten years after its entry into force).

### 5. International Security Assistance Force (ISAF)

The ISAF consists of multi-national forces (MNF) authorized by the UN Security Council. As of March 2010, a total of 85,000 military personnel from 43 countries have been maintaining public order and supporting post-war reconstruction work in Afghanistan.

### 6. Provincial Reconstruction Team (PRT)

This organization supports reconstruction work in Afghanistan. The PRT is located in the state of Parvan.

### 7. Ashena Unit

In Dari, the official language of Afghanistan, Ashena means "friend" or "coworker."

### 8. Dongmyeong Unit

Named after the founding father of the Goguryeo Dynasty, the Dongmyeong Unit refers to a unit being dispatched from the East in the hopes of bringing a bright and peaceful future to the region.



The Dongmyeong Unit conducting surveillance (Lebanon, March 2010)

### 9. Danbi Unit

The Korean word Danbi literally translates as 'Sweet Rain,' which refers to 'Welcomed or Timely Rain.' Therefore, the name of the Unit, Danbi, suggests that it will bring hope to Haiti like a welcomed rain.

► For more information, see Section 5 of Chapter 4, International Peacekeeping Operations

Government was selected to host the 2nd Nuclear Security Summit in 2012. After the 9/11 attacks, the United States and the rest of the world began the 'Global War on Terror (GWOT).' The International Security Assistance Forces (ISAF),<sup>5</sup> a force of the North Atlantic Treaty Organization (NATO), continues to operate in Afghanistan to eradicate the remnants of Al Qaeda and the Taliban, in cooperation with the Afghan troops. In July 2010, the ROK Government also dispatched a Provincial Reconstruction Team (PRT)<sup>6</sup> to join the international efforts to stabilize and reconstruct Afghanistan. Along with this, the ROK Government sent the country its Ashena Unit<sup>7</sup> to protect the PRT and help them to achieve their reconstruction mission.

The international community also continues its peacemaking activities to resolve local disputes in the Middle East. Israel and Palestine began dialogues at the 'Middle East Peace Conference' held in Annapolis, U.S., in November 2007. In September 2010, with the U.S. as mediator, the heads of both parties met in Washington to discuss possible solutions to the Israeli-Palestinian conflict. Further, as of March 2010, a 12,000 strong UN Peacekeeping Force (PKF), from 29 countries, was stationed in Lebanon to ensure public safety and security. The ROK Government dispatched its Dongmyeong Unit<sup>8</sup> to Lebanon in July 2007.

The African Union (AU) and the UN have both mediated efforts for peace and stability in the Darfur region of Sudan. Nonetheless, social conflict and bloodshed have been ongoing in the unchecked civil war. On the coast of Somalia, a protracted civil war area, repeated piracy has caused the international community to step up its joint efforts to tackle the problem. In March 2009, the ROK Government sent one destroyer and the 300-strong Cheonghae Unit to the region to secure the sea lanes of communications.

The international community also joined forces to help the victims of the mega-class natural disasters that hit Haiti in January 2010 and Chile in March 2010. In Haiti, not only non-military support, including relief supplies and medical aid, but also military support for reconstruction, public safety and security was provided. In March 2010, the ROK Government also dispatched its Danbi Unit<sup>9</sup> to Haiti to help the region recover from the earthquake.

# Security Landscape in Northeast Asia

Within Northeast Asia, mutual exchanges and multilateral cooperation have been increasing. Yet the causes for potential conflicts, such as North Korea's nuclear weapons, cross-strait relations, historical disputes, territorial disputes and the maritime demarcation issue, still exist leading concerned nations to compete against one another in bolstering their military power, which destabilizes the region.

## 1. The Regional Security Structure

Northeast Asia has many major economic and military powers that both confront one another and cooperate at the same time. Within this security structure, the major regional powers maintain mutually cooperative activities while competing one another in order to secure a dominant position in the region.

Solidifying its security ties with major Asia-Pacific alliances the ROK, Japan, Australia, and the United States have been trying to establish a more effective multilateral security system within the region based on alliances. After 'the Japan-Australia Joint Declaration on Security Cooperation'<sup>1</sup> was signed in March 2007, the United States conducted its first combined maritime exercise with Japan and Australia in October of the same year.

Since then two more drills of the same kind took place in September 2009 and June 2010, totaling three military exercises. The military cooperation between the three countries was strengthened through the Foreign and Military Director-General-Level Trilateral Talks held in April 2008.

### 1. Japan –Australia Joint Declaration on Security Cooperation

The first security cooperative agreement that Japan has with a country other than the U.S.

## 2. Shanghai Cooperation Organization (SCO)

An intergovernmental mutual-security organization that was founded on June 15, 2001, by the leaders of six countries: China, Kazakhstan, Kyrgyzstan, Russia, Tajikistan and Uzbekistan to strengthen mutual cooperation and increase regional security. A summit meeting is held every year.



Peace Mission 2010 (Kazakhstan, September 2010)



The Third Korea-Japan-China Summit (Jeju Island, May 2010)

## 3. The cross-strait issue

States the overall issues between China and Taiwan.



Long-range missile launch (April 2009)

China and Russia, too, have been strengthening their strategic partnership. The Shanghai Cooperation Organization (SCO),<sup>2</sup> formed under the leadership of China and Russia, held its first joint exercise, code-named the ‘Peace Mission,’ in 2005. The second exercise was held in August 2007, the third in July 2009 and, finally, the fourth in September 2010. Meanwhile, neighboring countries have been running parallel ventures in an effort to resolve their security uncertainties. A notable advance is that the summits involving the ROK, China and Japan were set up to discuss the security issues in the region. The summit, which had been held within the framework of ASEAN +3 since 1999, took place for the first time as a stand-alone dialogue in Japan in December 2008. The second meeting was held in China in October 2009 and the third in the ROK in May 2010.

At the same time, military exchanges in the region are actively taking place. China and Japan are expanding their military exchanges through mutual visits of high-ranking officials and navy vessels. The Chinese Minister of National Defense visited Japan twice in September 2007 and December 2009. In February 2010, Chief of Staff of the Japan Ground Self-Defense Force also visited China. In November 2007, a Chinese navy vessel made its first port call in Japan, followed by a reciprocal visit to China by a Japanese Maritime Self-Defense Force ship in June 2008. This was the first time a Japanese ship had docked in China since the end of World War II.

## 2. Security Issues in the Region

The multifarious threats posed by North Korea’s nuclear development, the cross-strait issue,<sup>3</sup> the territorial disputes and the maritime demarcation line issues in Northeast Asia demonstrate that Asia suffers more from disputes than any other region in the world.

North Korea’s nuclear issue poses a serious threat to global security beyond Northeast Asia. The Six-Party Talks for peaceful resolution of the North Korean nuclear issue has remained in a stalemate since December 2008, when a North Korean nuclear verification agreement failed to be adopted. Under these circumstances, North Korea launched a long-range missile in April 2009 and, in May of the same year, conducted a second

round of nuclear test that demonstrated its intention to possess nuclear weapons. The Six-Party Talks fell into a stalemate after the UN Security Council adopted a resolution against the North's long-range missile launches to which the North responded by denouncing the UN's resolution and completely refusing to resume the Talks. The parties of the Talks, the ROK, the U.S., Japan, China and Russia, have since continuously strived to have them resumed, but a NK's ambush torpedo attack on the ROK Ship Cheonan, in March 2010, was a major blow to these efforts and resulted in the Talks reaching a standstill once again.

To make the matters worse, the North disclosed its HEU facility in November 2010, followed by indiscriminate artillery shelling at Yeonpyeong Island in the West Sea, causing a security crisis on the Korean Peninsula. As a result, the resumption of the Six-Party Talks to resolve the North's nuclear issues still remains uncertain.

Cross-strait relations between China and Taiwan also pose a major threat to the security of Northeast Asia. With the rise of the Ma Ying-jeou government, whose core campaign was to improve cross-strait relations during the Taiwanese presidential elections held in March 2008, tensions appear to have eased between China and Taiwan. Soon after his inauguration, two cross-strait talks were held in June and November 2008. As a result, non-stop weekend flights between China and Taiwan were made available beginning in July, and in December of the same year, three types of exchanges<sup>4</sup> between the two parties took place, thus creating an amicable relationship. Nevertheless, the potential for cross-strait conflict still persists.

#### 4. Three exchanges

Cross-strait economic exchange, exchange of people and material through ports, and post exchange.

Differing historical views within neighboring countries, distortions in school textbooks and sovereignty disputes over some islands between China and Japan, as well as between Japan and Russia, remain factors that destabilize the Northeast Asian region. Besides, the establishment of the Exclusive Economic Zone (EEZ) to use oceanic resources has become a potential cause for disputes as the nations in the region stick with those positions considered most advantageous to their own interests.

### 3. Military Trends Exhibited by the Major Countries in the Region

Northeast Asia is the seat of global military power in which the combined military budgets in the region represent more than half of the global military budget. China and Japan are vying with each other to build up their navies and air forces, while the U.S. stays on top in military strength. Competition is becoming increasingly intense among the countries in the region as they attempt to gain dominance in the space race, with China emerging as the third top space powerhouse following the U.S. and Russia. The current military postures of the four major powers surrounding the Korean Peninsula are outlined in Figure 1-1.

► See Appendix 1: Military capabilities of neighboring countries.

Figure 1-1. Military Postures of the Four Major Powers Surrounding the Korean Peninsula



\*Source: *The Military Balance 2010* (London: International Institute for Strategic Studies, February 2010) and other relevant data. The defense budget was set as of 2009.



**| The U.S.: Military trends |** Based on the lessons learned from the 9/11 attacks, and the Afghanistan and Iraqi wars, the United States has been building its military capabilities to respond to diverse array of new threats, including irregular wars and terrorism, as well as traditional threats. The Quadrennial Defense Review (QDR) released in February 2010, which outlines the defense policies of the Obama Administration, points out the necessity of maintaining dominance and superior capability to win the ongoing wars as well as being able to respond to potential threats. Consequently, the U.S. is prioritizing its ongoing wars, including the one in Afghanistan, when it allocates its defense resources.

The U.S. Army is increasing the number of troops to complement the shortage that has arisen due to the wars in Afghanistan and Iraq. The U.S. Department of Defense (DOD) announced in 2007 that it would increase the number of Army troops by 65,000 to 547,000 by 2012. In addition, the DOD said that it would increase the number of troops by 22,000 for three years in total, from July 2009, to reach 569,000. Following the announcement of the end of the U.S. troops' combat mission in Iraq in August 2010, a huge number of U.S. troops that were stationed in Iraq are likely to be transferred to Afghanistan.

Considering the strategic importance of the Asia Pacific region, the United States has increased its Navy and Air Force presence in the area. The Navy replaced its conventional aircraft carrier, the USS Kitty Hawk, with the nuclear-powered aircraft carrier, the USS George Washington, in August 2008. The Navy deployed a new Virginia-class strategic nuclear submarine in the Pacific with a plan to concentrate 60 percent of its submarines in that region by 2010. The Air Force is pushing ahead with the automation of its aircraft as it improves its stand-off strike capabilities. In addition, the U.S. is increasing the number of its most current fighters, the strategic airlifter, the air refueler and unmanned surveillance planes, placed in Guam and Hawaii, which are power projection hubs in the Asia-Pacific region.



The U.S. Forces withdrawing from Iraq after the announcement of the end of the U.S. troops' combat mission in Iraq (the Iraq-Kuwait border, September 2010)

Coupled with its combat capacity build-up, the U.S. is also rearranging its military forces stationed in Northeast Asia. According to the ‘Roadmap to Realign US Forces’ agreed upon in May 2006, the U.S. and Japan have been reshuffling the U.S. troops in Japan. An example of such was when, in December 2007, the United States Forces Japan (USFJ) established the U.S. 1<sup>st</sup> Corps Forward Command at Camp Zama in Japan in order to execute integrated U.S. Forces’ missions in Japan. The 8,000 Marines stationed in Okinawa are scheduled to be relocated to Guam by 2014.

The ROK and the U.S. decided to relocate the U.S. Forces in Korea (USFK) to two different regions in order to safeguard a stable U.S. stationing. The USFK plans to maintain its troop strength at 28,500 as agreed upon at the ROK-U.S. Summit in April 2008. At another bilateral summit, held in June 2010, and in consideration of the changes in the security environment, the two countries agreed to adjust the timing of the OPCON transition from April 17, 2012, to December 1, 2015.

**| Japan: Military trends |** Japan set up its defense policy goals, which contained international peace cooperative activities, to ensure more effective responses to new threats and various incidents; to be ready for external attacks; and to improve its security environment. Therefore, the Japan Self-Defense Forces are seeking to strengthen their joint operational and intelligence capabilities. They are also striving to build an efficient system equipped with advanced science and technology while securing talented personnel.

The Japan Ground Self-Defense Force formed the Central Immediate Response Group in March 2007 to promptly respond to urgent incidents and to contain them from spreading. Considering the length of the country and its topological nature, some divisions and brigades were redeployed based on the mission so that units could operate flexibly. Within this integrated operational structure, the creation of the Integrated Ground Force is taking place in order to achieve an efficient command structure, and the development of a new tank, the TK-X, which was completed in June 2010, is scheduled to be deployed in the second half of 2011.



Newly developed TK-X tank

The Japan Maritime Self-Defense Force has systems that enable rapid and sustainable responses to various incidents. In March 2008, three fleet escort forces were realigned as four escort flotillas,<sup>5</sup> and the escort squadrons under each local unit were incorporated into the Escort Flotilla Command, thereby unifying the command system. In March 2009, the 13,500 ton Helicopter Aboard Frigate was deployed and the number two frigate is scheduled to be positioned in March 2011. In addition, the number three and number four frigates will have even a larger displacement of 19,500 tons, thereby four FFH being available in total. The submarine units were also reorganized to four units from six. P-1 maritime patrol aircraft to be developed by its own technologies will replace the old P-3C anti-submarine patrol aircraft.

The Japan Air Self-Defense Force is comprised of seven air wings. To maintain the combat capability while reducing the number of fighters, the Japan Air Self-Defense Force is implementing its next fighter project (FX) while improving the performance of the F-15 and F-2. To effectively respond to attacks on remote isles and to support the international cooperative peacekeeping activities of the Self-Defense Forces, in March 2009, it introduced four air refuelers (KC-767) and has operated these since April 2010. Furthermore, Japan is developing a new transport aircraft, the XC-2, to replace the old C-1.

To further enhance its intelligence collection capabilities, the Japan Air Self-Defense Force completed its four intelligence satellites in February 2007 and passed the Space Basic Act<sup>6</sup> in May 2008 establishing a legal basis for military use of space in the future and for the development of a high performance reconnaissance satellite.

On the other hand, in response to the North Korean missile threat, Japan has made continuous efforts to establish a joint missile defense (MD) system with the U.S. To this end, Japan deployed ground-based interceptor missiles (PAC-3) at 16 locations, including Japan Air Self-Defense Force (JASDF) bases and training and educational camps, from March 2007 to April 2010. From 2007 to 2009, Japan loaded a total of three Aegis destroyers with SM-3 missiles, SM-3 was loaded on an Aegis per year. An

#### **5. Japan Maritime Self-Defense Force and Escort Flotilla**

The Japan Maritime Self-Defense Force, a mobile unit that is capable of independent surface warfare, anti-submarine warfare and anti-air warfare, has four escort flotillas made up of two escort squadrons (each escort squadron is composed of four frigates). Additionally, a Hyuga-class Helicopter Aboard Frigate is being built to be used as a flagship for each escort flotilla.

#### **6. The Space Basic Act**

The Act was enacted in May 2008 in Japan to ensure the development and use of space. It is composed of the basic guidelines for space development, the related organizations, and the general planning and space activities.

## 7. FPS-5

A missile detection and tracking radar developed by Japan in 2003 and used by the Japan Air Self-Defense Force. As the threat of missile attack by North Korea has increased, multi-ballistic missiles and aircraft can now be simultaneously tracked and detected with much improved performance.

## 8. Defense Budget of China

At the 3<sup>rd</sup> Convention of the 11<sup>th</sup> Term National People's Congress in March 2010, China announced an increase in its defense budget by 14.9% to USD 78 billion (RMB 532.1 billion), which accounted for 6.3% of its total national budget and 1.4% of its GDP. *The Military and Security Developments Involving the People's Republic of China*, released by the U.S. Department of Defense in August 2010, estimated the actual Chinese defense budget has doubled the amount in real terms that was officially announced by the Chinese Government.

FPS-5<sup>7</sup> radar for the surveillance and tracking of ballistic missiles was also loaded on each Aegis.

**| China: Military trends |** China is pushing ahead with the modernization of its military through continuous increase in its national defense budget<sup>8</sup> backed by its rapid economic growth. This is part of its efforts to pursue a military strategy aimed at 'winning in limited warfare under modern conditions.' Within this strategy, China is pursuing strengthening its PLA Navy and Air Force with state-of-the-art weaponry, in preparation for local wars, and active defense against any attack to accomplish its goals of national defense: anti-invasion and unification. To this end, the PLA Army is enhancing its rapid-response capability, the PLA Navy on its stand-off strike capabilities, and the PLA Air force on its long-distance operational capability.

To strengthen its timely response capability, the PLA Army successfully carried out experimental airdrops of tanks by airborne units, using a new tank airlift and drop system, in Guangzhou, in April 2007. It also completed development of a new armored vehicle, the VN-3, in January 2008, and in the same year, deployed the Z-10 attack helicopter for use in war.

Between 1995 and 2007, the PLA Navy introduced four Sovremenny-class destroyers (7,900 tons) and 12 Kilo-class submarines (3,000 tons) obtained from Russia in order to enhance its stand-off strike capabilities. In 2007, it deployed two Chinese Aegis-class destroyers (6,500 tons) and, currently, is building three more destroyers. Furthermore, in 2008, the PLA Navy also deployed two new Jin-class strategic nuclear submarines equipped with Julang (巨浪)-II ballistic missiles with a range of over 8,000 km. Further test-runs were scheduled. It plans to deploy a total of five Jin-class strategic nuclear-powered submarines by 2012.

The PLA Air Force deployed its indigenous J-10 fighters in 2007 and is now developing the modified versions of the J-10: the J-13 and J-14 stealth-type fighters. In addition, while introducing its most advanced fighters,

including the Su-27/30 from Russia, the PLA Air Force is concentrating its efforts on licensed production via technology transfer and indigenous aircraft production. It also has four Airborne Warning and Control Systems (AWACS), the large KJ (空警)-2000, and four small KJ-200 aircraft. In addition, the Air Force possesses 18 air refuelers and has expanded its operational radius of fighters by complementing its existing refueling facilities and equipment.

In January 2007, China successfully carried out an anti-satellite test in which a ballistic missile destroyed a satellite. In October of the same year, the country launched a satellite to carry out surveillance of the moon, which was followed by another in October 2010. All of this shows the country's determination to become a major player in space exploration.

**| Russia: Military trends |** Since October 2008, Russia has been reforming its military to nurture a force capable of rapidly responding to future security threats. Russia announced its amended National Security Strategy (NSS) 2020<sup>9</sup> and Military Doctrine,<sup>10</sup> the blueprint for the mid-to long-term Russian defense policies, in May 2009 and February 2010, respectively. The gist of the defense reform is to maintain the total number of troops at one million and to integrate the military units, reorganizing them into a standing military system. The existing four-tier command structure, which is comprised of a Military District – Army – Division – Regiment structure will be replaced with the three-tier structure of military district – operational command – brigade, while closing six military districts. In addition, Russia plans to establish regional headquarters in four districts to ensure its joint combat capability depending on the direction of any threats.

To continue to deter nuclear threats and prepare for low-intensity conflicts, Russia is modernizing its conventional weaponry. Every year, 9-10% of its military equipment is being replaced. Russia also plans to upgrade 30% of its military equipment by 2015 and 70% by 2020.



The J-10 Fighter in the 60<sup>th</sup> Anniversary of the PLA Air Force (Beijing, 2009)

#### **9. National Security Strategy (NSS) 2020**

A policy document to replace the National Security Concepts of the Republic of Russia (2000). The document outlines Russia's national security objectives: 'Russia enhances its status as a world power' and suggests the directions necessary to become a top five global economy and to achieve stable economic development in this multipolar international order.

#### **10. Military doctrine**

The Guidelines for National Defense Strategy, which was revised for the third time following revisions in 1993 and 2000. Current list of military doctrine contains a number of clauses that include: overseas deployment for protective purposes on Korean citizens residing abroad; prepare for low-intensity conflict while considering nuclear arsenals as a war deterrence mechanism; state-of the art conventional weapons regarded as a hallmark of force build up.etc.



The Dolgorukiy, a Borei-class strategic nuclear-powered submarine

Russia possesses ground-based, sea-based, and air-based intercontinental ballistic missiles (ICBMs). Russia has deployed the Topol-M (SS-27) and multi-warhead RS-24 guided missiles, all of which are ground-based ICBMs. Submarine-based ICBMs (SLBM) will use the SS-N-23, a guided missile (Sineva), while in the Borei-class strategic nuclear-powered submarines, the SS-NX-30, the guided missiles (Bulava) under development will be mounted.

For its ground forces, Russia has modernized its conventional equipment, while deploying T-90 tanks, new armored vehicles and an air defense system. Combat units have been reorganized to place a brigade at their center, instead of a division. In addition, Russia has established the Rapid Response Forces.

The Navy has focused on modernizing its old system for littoral operations, while improving its blue-ocean projection capabilities. Currently, multi-purpose surface combatants, Lada-class conventional submarines, Borei-class strategic nuclear-powered submarines, Yasen-class nuclear submarines and Aegis destroyers are being built. Russia is also planning to build a new aircraft carrier. In addition, it is trying to procure a large Mistral-class amphibious assault ship from France, while the Navy Command, located in Moscow, is scheduled to relocate to St. Petersburg.



Heads of member states participating in the Collective Security Treaty Organization (CSTO) talks (Yerivan in Armenia, August 2010)

Equipped with long-range precision strike capability, the Air Force has been improving its air defense capabilities. To this end, it has been upgrading its Tu-95/160 strategic bomber and developing stealth strategic bombers. It is planning to deploy Su-35 fighters and fifth-generation fighters. S-400 ground-to-air missiles are being deployed around the outskirts of Moscow and major areas.

Russia is strengthening its multiple military cooperative relationships with its former Soviet Republics. Since 2005, it has been carrying out a joint exercise called the 'Peace Mission' with the member nations of the

Shanghai Cooperation Organization (SCO). In June 2009, Russia also established the 10,000-strong Rapid Response Force of the Collective Security Treaty Organization (CSTO).<sup>11</sup> Depending on the issue, Russia cooperates with the international community while, at other times, keeping it in check. Russia stays within the international collaborative system against transnational threats but cautiously views NATO's Look-East Policy and the U.S. establishment of the Missile Defense (MD) system in Eastern Europe, regarding them as a security threat against Russia.

**11. The Collective Security Treaty Organization (CSTO)**

A collective security organization formed by Russia with other former Soviet Republics: Belarus, Armenia, Kazakhstan, Tajikistan, Kyrgyzstan, and Uzbekistan.

# Section 3

## North Korean Situation and Military Threat

Despite the sanctions levied by the international community and its economic hardships, North Korea has put its utmost effort into constructing a strong and prosperous nation by the year 2012. The fact that North Korea has the world's fourth largest conventional military force and that it has developed WMDs, including nuclear weapons, poses a serious threat to peace on the Korean Peninsula.

### 1. North Korean Situation

**| Domestic front |** North Korea is ruled by a dictatorship controlled by the Korea Worker's Party: the one and only party in the nation. It claims to be a socialist country, under the banner of the Juche ideology and the Military First Policy. Since the 1990s, when the instability of the regime intensified due to the inherent problems in socialism, worsening economic problems and isolation from the international community, the North has strengthened its 'Military First Policy' and has utilized all of its resources and skills to build "a strong and prosperous nation" by 2012. Since Kim Jong Il's health began to deteriorate in 2008, the North has concentrated its efforts on consolidating the regime and carrying out large-scale personnel and organizational changes. It also announced a dynasty-style power succession over three generations, with Kim Jong Il's third son Kim Jong Un designated as the heir-apparent, at the conference of Party Representatives Meeting held on September 28, 2010, the first such meeting in 44 years.

After the 'July 1 Measures'<sup>1</sup> in 2002, the North has promoted reforms and opening up policy albeit limited, still adhering to their socialist economic system. Nonetheless, the North Korean economy has sputtered and stalled, rather than attaining the economic strength sought.

#### 1. July 1 Measures

An economic reform was implemented on July 1, 2002, to rebuild the economy, which was facing further hardships during the 1990s, by partially adopting elements of a market economy



Moreover, the economic sanctions imposed on the country by the international community, due to a second nuclear test and continued missile launches, have exacerbated its economic situation and pushed its planned socialist economy to a near collapse. To overcome this crisis, North Korea came up with general mobilization plans, such as the ‘150-Day Battle’ and ‘100-Day Battle’<sup>2</sup> conducted in 2009. These, however, did not come to fruition. In November 2009, North Korea launched a currency reform<sup>3</sup> that only further aggravated the instability by resulting in inflation, a reduction in economic activity and the estrangement of public sentiment.

As external ideas, including capitalist ideology, are introduced, North Koreans’ belief in the Juche Ideology and their sense of loyalty to the regime have been weakening. As a result, more North Koreans have complained about the regime, and the number of North Korean defectors around the border areas is on the rise. However, North Koreans dissatisfied with the regime find themselves unable to get sufficiently organized in order to defy the regime. Indeed, the authorities have tightened their grip on the population by rounding them up for various events and making them attend daily ideological sessions in an effort to solidify Kim Jong Un’s position as the heir apparent.

**| Policies toward the South** | The North has adopted the tactic of obtaining economic aid from the South, stressing the need for collaboration between the two Koreas (expressed in the slogan “Uri Minjok Kiri”) and asking the South to fulfill promises contained in the June 15 Joint Declaration and the October 4 Declaration. However, right after the launching of the Lee Myung-bak Administration, the North started denouncing the South’s policies as being hostile, taking a hard-line stance toward the South, and halting all dialogues.

Since early 2008, North Korea has taken extreme measures: the North unilaterally deported the South Koreans in charge of the Office of Inter-Korean Economic Cooperation in the Kaesong Industrial Complex (March 27, 2008), cut off the Panmunjom hot line (November 12, 2008), and blocked crossing of the Military Demarcation Line (MDL) (December 1, 2008). Following those moves, up to the first half of 2009, when it

## 2. 150-Day Battle and 100-Day Battle

The national ‘Labor Mobilization Movement’ to overcome the economic crisis in 2009.

150-Day Battle: April 20 to September 16 (presumed).

100-Day Battle: September 23 to December 31(presumed).

## 3. Currency Reform

A measure to exchange the old currency with a new one at a ratio of 100: 1 was taken on November 30, 2009.



A spokesperson of the Korean People’s Army (KPA) declares a posture of all-out confrontation (January 17, 2009)

conducted its second round of nuclear tests, the North had continuously employed a hard line stance. It made various threats and declared a posture of all-out confrontation (January 17, 2009). It also announced the cancellation of the military and political agreements (January 30, 2009) while stating that it would ‘turn Seoul into a sea of fire’ (June 12, 2010).

The North made brief conciliatory gestures toward the South in the second half of 2009 in order to avoid the economic hardships and further isolation caused by the international community’s sanctions. But it turned hawkish again in late 2009, after it failed to achieve its goals.

As a result, North Korea has taken provocative actions and hard-line measures, including a navy clash near Daecheong Island, the so-called Daecheong Naval Campaign<sup>4</sup> (November 10, 2009), establishing a ‘no-sail zone’ in the NLL in the West Sea and firing at coastal areas (January 2010), and freezing South Korean assets in Mt. Kumgang (April 2010). In addition, the North orchestrated a torpedo attack on the ROK Ship Cheonan, which was conducting patrol operations before being sunk 2.5km southwest of Baengnyeong Island on March 26, 2010. A total of 46 ROK sailors perished in this attack, which heightened the security crisis on the Korean Peninsula and in Northeast Asia. Regarding this attack by the North, on July 9, 2010, the UN Security Council adopted a Presidential Statement that condemned North Korea for the provocative action. Yet, the North threatened the South by stating that it would conduct an all-out war and a third round of nuclear tests in response to the South’s measures against the North that were coordinated with the international community. Furthermore, on November 23, 2010, the North indiscriminately fired approx. 170 artillery shots at a ROK Marine detachment and the civilian residential area on Yeonpyeong Island. In response to this attack, the ROK Marine immediately fired back with K-9 self-propelled guns at the North. Two ROK Marines and two civilians were killed while 16 Marines and many other civilians were wounded, including some severely injured. The rest of the world, including the U.S., Japan, Germany, the U.K., and Russia, denounced the North for this brutal act that had killed and injured civilians.

As well illustrated in the above instances, to unify the two Koreas

#### 4. Daecheong Naval Campaign

A North Korean patrol boat crossed the NLL east of Daecheong Island on November 10, 2009. A ROK PKM fired warning shots. In response, the North’s boat began aiming shots at the ROK patrol craft, resulting in a battle.

► See special Appendix 2 The North’s infiltrations... at the Northern Limit Line (NLL)

under Communist control, North Korea has sought to create tension in the ROK-U.S. alliance and divisions in public opinion within South Korea. It also continues to make military threats against the South, including those based on its nuclear development program, and does not make any effort to build military confidence with the South to ease the tension and establish lasting peace on the Korean Peninsula.

**| Foreign policies** | North Korea regards WMDs, including nuclear weapons, as a means of survival. Despite UN Security Council Resolution 1874<sup>5</sup> and the economic sanctions prompted by a second round of nuclear tests in May 2009, the North is still holding its nuclear program as a negotiating card in its brinkmanship tactic<sup>6</sup> with the rest of the world and is focusing every resource available on the survival of the regime. However, the cut off of economic aid by the international community has severely aggravated its already ailing economy, and the Six-Party Talks that were designed to resolve the North Korean nuclear issue have been halted since December 2008.

Highly dependent on China's support, North Korea has been struggling to maintain its regime and to recover its economy. As part of its efforts, the North has tried to strengthen the traditional alliance with China through such events as Chinese Prime Minister Wen Jiabao's visit to North Korea in October 2009, and the North Korean leader Kim Jong Il's visits to China in May and August in 2010. Pyongyang has been demanding Washington to recognize it as an official nuclear power and ensure the regime's security through their bilateral talks. However, the U.S. has taken the consistent stance of demanding that the North abandon its nuclear program through dialogues and sanctions in parallel. Hence, the North has failed to accomplish its goals. As for its relations with Russia, North Korea has maintained this relationship in order to earn both economic and strategic security benefits. Meanwhile, little progress has been made in its relations with Japan since Japan applied a higher level of economic sanctions against the North following its lukewarm attitude toward the Japanese abduction issue and its nuclear tests.

North Korea seeks friendly relationships with the non-Western world,

#### **5. UN Security Council Resolution 1874**

The UN Security Council unanimously adopted Resolution 1874 on June 12, 2009, in condemnation of the second round of nuclear tests by North Korea.

#### **6. The Brinkmanship tactic**

An extreme and intimidating tactic that North Korea has exerted at nuclear negotiation tables with the U.S.

including Africa and the Middle and South America, while continually striving to attract more investment from European countries.

## 2. Military Threats

**| Military strategy |** Under the cloak of the Juche ideology, North Korea sticks to the Self-Defense Principle to justify its continuous buildup of military power. Since adopting the Four-Point Military Lines<sup>7</sup> in 1962, the North has continued to put military power first. Since Kim Jong Il attained power, under the banner of the Military First Policy, the top priority of the North has been to possess a military capacity superior to that of South Korea.

The basic national goal of North Korea is “unification of the two Koreas under communist control,” which is unlikely to change as long as the current Kim Jong Il and the Kim Jong Un regime retains power. To realize this goal, the Korean People’s Army (KPA) has used surprise attacks, composite warfare and a short-term blitzkrieg strategy, while seeking various tactics and mixed warfare in consideration of the ROK forces’ high-tech weaponry and the nature of modern warfare. In addition, the North has been concentrating on its asymmetric military capabilities, including WMDs, special forces, long-range artillery, underwater forces and cyber attacks, while selectively increasing its conventional weapons. The KPA’s asymmetric forces, in particular, pose a serious threat to the ROK military because they can be used as a core means of attack during war time and for local provocations during peace time.

**| Military command organizational structure |** The National Defense Commission (NDC) is the highest-ranking military command organization in North Korea. It directs overall military matters and defense-related construction programs. (The Socialist Constitution of North Korea, Articles 106 and 109). As the Chairman of the NDC, the Chairman of the Control Military Committee of the Worker’s Party, and a Presidium member of the Worker’s Party, Kim Jong Il controls military organizations, such as the General Political Bureau, the General Staff Department, and the Ministry of the People’s Armed Forces.

### 7. Four-Point Military Lines

- Instilling cadre potential in every soldier
- Modernizing the entire military
- Arming the entire population
- Turning the whole nation into a fortress

The military organizations that Kim Jong Il's directions directly receive are the Body Guard Command and the Military Security Command. The former is in charge of protecting Kim Jong Il, his family and high-ranking officials of the Worker's Party as well as guarding Pyongyang. The latter serves as the secret police within the military that remains vigilant for anti-Kim Jong Il factions. The General Political Bureau controls matters concerning the organization of the party within the military and political ideology. The General Staff exercises military command authority, i.e., the right to conduct military operations. The Ministry of the People's Armed Forces represents the military externally and exercises military administrative rights, i.e., rights concerning military diplomacy, logistics, administration and finances. The North's military command organization is as shown in Figure 1-2.

Figure 1-2. North Korea's Military Command Organization

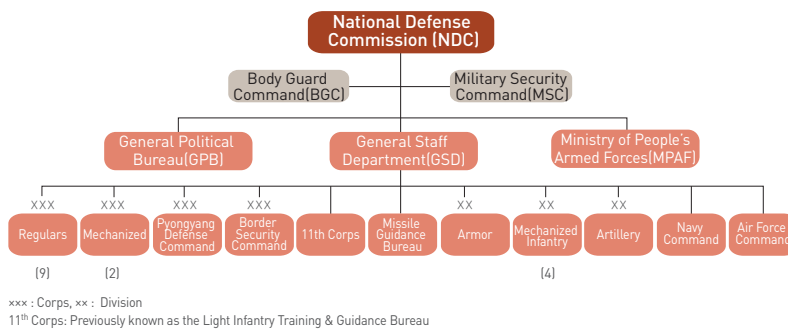

**Military capabilities** | Under the General Staff Department, the ground forces are organized into nine regular corps, two mechanized corps, the Pyongyang Defense Command, the Border Security Command, the 11th corps previously known as the Light Infantry Training & Guidance Bureau (LITGB), and the Missile Guidance Bureau, numbering a total of 15 corps level units.

North Korea has deployed about 70 percent of its ground forces to south of the Pyongyang-Wonsan line, and some of its forces are ready to make a surprise attack from secure positions around the Northern Boundary of the MDL. The 170mm self-propelled artillery and 240mm multiple rocket



Firing 170mm self-propelled artillery

launchers have been kept in place, and with those weapons, the KPA is capable of carrying out a massive surprise artillery attack on the Greater Seoul metropolitan area.

The mainstay of the armored and mechanized units now involves the T-54 /55 tanks and the 'Cheonmaho' tank that is an upgrade over the T-62 tank. Recently, some of the units subordinate to the mechanized corps were moved to the frontline and new tanks replicated after the T-72 tank were developed and operationally deployed. Due to the deployment of the new tanks, the replaced ones are being used in the rear areas. Likewise, North Korea is maintaining the short-term blitzkrieg strategy and is improving its operational flexibility by reinforcing the mobility and strike capabilities of its mobile units.

The North has been strengthening its special warfare capabilities by deploying light infantry divisions<sup>8</sup> to the frontline corps and adding an infantry regiment to the frontline. The number of special force troops is estimated to reach approximately 200,000. It is assumed that these troops have been trained to conduct composite operations, such as major target strikes, assassination of important figures, and disruption of rear areas, after infiltrating the rear areas of the South through either underground tunnels or AN-2 planes. The current major weapons possessed by the North Korean ground forces are shown in Figure 1-3.

#### 8. Light infantry division

Organized under the frontline corps, this division for special warfare contributes to the operations of the regular corps by infiltrating into mountainous regions. In addition, it conducts large-scale composite operations and operations to disrupt rear areas.



March of special warfare units

Figure 1-3. The North Korean Ground Forces' Major Weapons

				
<b>Tanks</b>	<b>Armored vehicles</b>	<b>Field artillery</b>	<b>MRL</b>	<b>River-crossing equipment</b> <small>K-61/S type pontoon bridge</small>
approx. <b>4,100</b>	approx. <b>2,100</b>	approx. <b>8,500</b>	approx. <b>5,100</b>	approx. <b>3,000</b>

**The Navy** consists of two fleet commands, 13 squadrons, 40 bases and two maritime sniper brigades for special operations organized under the Naval Command.

While it is assumed that there have not been major changes in the Navy's operational capabilities, new submarines and torpedoes are believed to be under development. About 60 percent of the Navy is deployed in forward naval bases south of the Pyongyang-Wonsan line. Thus, the North is capable of springing ambush attacks. However, rather than operating independently, the Navy conducts operations in tandem with the ground forces by supporting the deployment of ground forces and by defending coastal areas.

As for its military capabilities for surface warfare, the Navy is equipped with the surface battle group consisting of guided missile patrol boats (PTG), torpedo boats, small patrol boats and fire support patrol craft (PCFS) that all have the ability to fight as individual attack ships. However, these surface combatants are mostly comprised of small high-speed vessels that have poor mobility under bad weather conditions and limited operational capabilities at sea.

As for underwater warfare, the Navy possesses 70 submarines, including Romeo-class, Sang-o (Shark)-class and Yeon-o (Salmon)-class submarines, and its missions are to lay mines, attack surface ships and support the infiltration of corps for special warfare. As witnessed in its attack on the ROK Ship Cheonan, when it used new torpedoes to attack the ROK ship, North Korea will continuously develop asymmetric tactics to attack ROK naval vessels that feature weapons systems far superior to those of the North.

The North Korean Navy also operates landing vessels produced since the early 1970s, including a total of 260 vessels such as Landing Craft Air Cushion and personnel landing craft and 30 mine sweeping boats. The maritime sniper brigades and the navy reconnaissance battalions strike at major facilities, such as radars and naval bases, by secretly infiltrating into those target facilities. In addition, they will secure major strategic ground areas along with coastal lines to support short-range amphibious operations that do not require large landing craft. The number of vessels possessed by the North Korean Navy is shown in Figure 1-4.

Figure 1-4. The number of vessels possessed by the North Korean Navy

				
Surface combatants	Submarines	Landing vessels	Mine sweeping boats	Others
approx. 420	approx. 70	approx. 260	approx. 30	approx. 30

The Air Force is comprised of four air divisions, two tactical transportation brigades, two sniper brigades, and air defense units all of which are under the direct control of the Air Force Command. Except for the aircraft introduced after 1980, most North Korean aircraft are decrepit. However, an apparent change in its military capacity has not been seen with the introduction of a new fighter.

The Air Force divided the entire territory into four districts when deploying its units. Of the total force size, 40 percents are deployed to forward bases located south of the Pyongyang-Wonsan line, thus guaranteeing a readiness to launch surprise attacks on the South’s major facilities.

The North Korean Air Force will carry out surprise attacks at the beginning of a war so as to destroy South Korea’s air defense assets, supply routes, industrial and military facilities and national infrastructure. In particular, with AN-2s and helicopters, the North is capable of dropping its special warfare forces deep in the South’s rear areas.

The North’s air defense system is centered on the Air Force Command, in which are the integral parts of the system: aircraft, ground-to-air missile units, anti-aircraft artillery units and radar units. Dividing the air space into four zones, the first stage of air defense is assigned to the Air Division. SA-3 missiles have been placed in the Pyongyang area and major military facilities and SA-2/5 ground-to-air missiles have been deployed in defense of the whole Military Demarcation Line (MDL) area and the east and west coasts. Anti-aircraft artillery has been heavily deployed in mobile units to protect major cities, ports and military-industrial facilities.



KN-06 Ground-to-Air Missiles



Radar units, including ground controlled interception bases and early warning bases, are spread evenly across North Korea to cover not only the entire Korean Peninsula but also parts of China. In addition, the automated air defense control systems have been enhanced so as to shorten response time and improve accuracy. The North Korean aircraft inventory is shown in Figure 1-5.

Figure 1-5. North Korea's Air Force Aircraft

				
<b>Fighters</b>	<b>Reconnaissance aircraft</b>	<b>Transport aircraft (AN-2 included)</b>	<b>Helicopters</b>	<b>Trainers</b>
approx. <b>820</b>	approx. <b>30</b>	approx. <b>330</b>	approx. <b>300</b>	approx. <b>170</b>

**The reserve forces** are comprised of the Reserve Military Training Unit, the Worker and Peasant Red Guard, the Red Youth Guard, and para-military units. Civilians between the ages of 14 and 60, approximately 30 percent (7.7 million) of the entire population, are subject to wartime mobilization in North Korea. The status of the reserve forces is shown in Table 1-1.

Table 1-1. The Reserve Forces of North Korea

Division	Strength	Note
Reserve Military Training Unit	approx. 0.6 million	<ul style="list-style-type: none"> <li>•Subject to combat mobilization               <ul style="list-style-type: none"> <li>- men between 17 and 50</li> <li>- women between 17 and 30</li> </ul> </li> </ul>
Worker and Peasant Red Guard	approx. 5.7 million	<ul style="list-style-type: none"> <li>•Equivalent to the ROK's Homeland Reserve Forces</li> </ul>
Red Youth Guard	approx. 1 million	<ul style="list-style-type: none"> <li>•Military organization of middle school students</li> </ul>
Para-military units	approx. 0.4 million	<ul style="list-style-type: none"> <li>•Body Guard Command, Ministry of People's Security</li> <li>•Logistics Mobilization Guidance Bureau, Speed War Youth Shock Troops</li> </ul>
Total	approx. 7.7 million	

Among all of these units, the Reserve Military Training Unit is the core reserve force, and its training is as intense as that of the standing forces. In addition, the Unit continuously enhances its combat capabilities by receiving old equipment from the regular army whenever their equipment is upgraded. The Reserve Military Training Unit undergoes intensive training to enable it to replace the regular forces, if need be, during wartime.

To secure strategic weapons, North Korea has been continuously developing nuclear weapons, ballistic missiles and biochemical weapons. In the 1960s, North Korea constructed a nuclear complex in Yongbyon and, in the 1970s, concentrated its nuclear research on nuclear fuel milling, conversion, and fabrication technologies. From the 1980s to 2009, it has extracted nuclear material from a 5-megawatt reactor and reprocessed spent fuel rods four times. Pyongyang is now presumed to have acquired approximately 40 kilograms of plutonium. Indeed, the North conducted nuclear tests in October 2006 and May 2009. In an announcement by a foreign affairs department spokesperson in April 2009, North Korea suggested that it had completed the ‘enrichment of uranium,’ followed by its claim in November 2010 that it was running around 2,000 centrifuges. Considering the above mentioned, it is suspected that the North has pursued a highly enriched uranium (HEU) program.

North Korea embarked on the development of ballistic missiles in the 1970s, and by the mid-1980s, it had produced and operationally deployed 300km-range Scud-Bs and 500km-range Scud-Cs.

In the 1990s, North Korea deployed 1,300km-range Rodong missiles for operational purposes. In 2007, it began to develop new intermediate range ballistic missiles (IRBMs) called the Musudan<sup>9</sup> with a range that extended beyond 3,000km and which were capable of direct strikes on neighboring countries, including South Korea, Japan and Guam. Since the 1990s, North Korea has been carrying out ICBM development and conducted a test-launch of the Taepodong-1 and Taepodong-2 missiles in 1998 and 2006, respectively. In April 2009, the North launched a long-range missile. The ranges of the missiles are shown by type in Figure 1-6.

#### 9. Musudan

Named after Musudan, Hwadae-gun, Hamgyeongbuk-do, where the North's missile development facilities are located.



Musudan missiles on display at the anniversary of the KWP (October 2010)

Figure 1-6. The Ranges of the North's Missiles by Type



It is believed that approximately 2,500 to 5,000 tons of chemical weapons remain stored in the facilities scattered across the country. The North is also suspected of being able to independently cultivate and produce such biological weapons as anthrax, smallpox, and cholera.

To maintain its war sustainability and logistical mobilization capabilities, North Korea has prioritized its military industry, despite its energy and economic crises.

The North retains about 300 logistics factories. In addition, non-military production facilities that are designated as logistics factories can also, on short notice, be used for logistical mobilization during wartime. Most of the war stockpile is kept in hardened underground storage facilities, and the quantity of the war stockpile has been estimated to be sufficient for two to three months. However, without additional purchases from the outside or external support, North Korea's ability to engage in a protracted war would be limited.



ROK Armed Forces Major Commanders  
General Meeting (MND, May 2010)



# Chapter 2

## National Security Strategy and Defense Policy

Section 1. National Security Strategic Guidance

Section 2. Objectives and Tenets of the National Defense Policy

# Section 1

## National Security Strategic Guidance

As a national action plan, the National Security Strategy (NSS) is designed to utilize available resources and means in a comprehensive and systematic manner in order to assure national security. Setting its national vision of a 'World Class Nation through National Advancement,' the Lee Myung-bak Administration is moving towards a Global Korea.<sup>1</sup> As part of realizing this vision on the security front, the Administration has issued the National Security Strategic Guidance. The Ministry of National Defense (MND) has been concentrating all of its capabilities to attain its national security objectives and to support relevant national policies.

### 1. Global Korea

This concept, which is high on the Government's agenda, is a vision aimed by the Government towards the national security sector. It asks for the country to contribute to world peace and seek co-prosperity through proactive and open foreign policy that pursues exchanges and collaboration with the rest of the world on a variety of global issues, including economic, cultural and environmental ones, rather than relying on a diplomatic and security solution confined to the Korean Peninsula and North Korea's nuclear issues.

### 1. National Vision and National Security Objectives

The Lee Myung-bak Administration established the national vision of becoming a 'World-Class Nation through National Advancement' based on the principles of having free democracy and market economy, which are the fundamental ideas of the Constitution of the Republic of Korea. A World-Class Nation would achieve both economic development and social integration built upon world-class civil consciousness and culture as well as top-notch science technologies and industries.

The national security objectives must be achieved to ensure national security by considering the current security environment and evaluating the available national power. Keeping security in the forefront of the mind, the ROK Government set its national security objectives as maintaining stability and peace on the Korean Peninsula; establishing the foundation for citizens' safety and national prosperity; and enhancing the country's international capacity and stature.



President Lee Myung-bak delivering his new year's address (January 2010)

First, 'maintaining stability and peace on the Korean Peninsula' means that the ROK Government will ensure the constant stability and peace on the Korean Peninsula, based on its own defense capability and the ROK-U.S. alliance, by engaging in inter-Korean exchanges and cooperation, along with multifaceted collaboration with its neighboring countries.

Second, 'establishing the foundation for public safety and national prosperity' signifies that the Government will ensure public safety from multifarious security threats and will achieve the social and economic security on which national prosperity can be grounded.

Third, 'enhancing the country's international capacity and stature' refers to the ROK making such great strides towards becoming a Soft Strong Power by actively contributing to world peace, freedom and democracy, and co-prosperity while strengthening its collaborations with the international community.

## 2. Tenets of the National Security Strategy (NSS)

The Korean Government has specified the following three tenets of the National Security Strategy (NSS): first, creating a new peace structure; second, carrying out pragmatic diplomacy and openness; and third, seeking advanced security that reaches out to the world.

## 2. Strategic Alliance towards the 21<sup>st</sup> Century

Under the Strategic Alliance towards the 21<sup>st</sup> Century, the ROK and the U.S. agreed to abide by, first, claiming to stand for a liberal democracy, market economy and humanitarianism, and promote such ideals befitting of the Korean Peninsula, Northeast Asia and the World, second, broadening and deepening their mutually-dependent relationship on the social, economic and cultural fronts on the basis of their solid, long-lasting military alliance, and third, developing the alliance such that it can contribute to regional and global peace and confidence building, while bolstering strategic cooperation with other neighboring countries in the region.

First, the goal of ‘creating a new peace structure’ will be achieved by the following: advancing the inter-Korea relationship in a future-oriented way to arrive at mutual benefits; pushing forward with the ‘Strategic Alliance towards the 21<sup>st</sup> Century’<sup>2</sup> with the United States in a manner that will contribute to bringing about peace on the Korean Peninsula, regional stability, and also world peace; and constructing a close and cooperative relationship with neighboring countries.

Second, in order to carry out ‘pragmatic diplomacy and active openness,’ the ROK will implement a pragmatic foreign affairs campaign that could revitalize the economy and energy diplomacy; pursue international cooperation and contribution diplomacy that commensurate with Korea's economic and diplomatic capabilities.

Third, in seeking advanced security that reaches out to the world, the ROK will build its military capabilities and advanced defense operational systems that proactively respond to the changes in the security environment and future warfare; enhance the competence of its comprehensive security to ensure its responsiveness to multifarious security threats; actively engage in international peacekeeping operations and reconstruction activities.

In order to realize the tenets of the NSS, the Government has been implementing strategic tasks by sectors. The core strategic task in the national defense sector is to build a ‘future-oriented security capability.’ To achieve this goal, the MND has been concentrating its resources to attain Defense Vision of fostering an ‘Advanced Elite Military.’ In addition, it established the Defense Reform Basic Plan in December 2005 and has since periodically evaluated and improved the Plan.



# Objectives and Tenets of the National Defense Policy

The MND has proclaimed an ‘Advanced Elite Military’ as its Defense Vision to realize its national security and national defense objectives in this fast changing security environment. To this end, the MND set up eight key defense policy tenets to ensure consistent implementation of the defense policies across different sectors.

## 1. National Defense Objectives

There are three national defense objectives: defending the nation from external military threats and invasion ; upholding the principle of peaceful unification ; and contributing to regional stability and world peace. The specific details of these objectives are as follows:

First, ‘defending the nation from external military threats and invasion’ signifies that the MND will protect the nation from North Korea’s existing military threat and, further, from all other potential threats to the peace and security of the ROK. The North has posed serious threats to the South’s security with its large-scale conventional military forces, development and enhancement of WMDs, including nuclear weapons and missiles, and constant armed provocations as shown by the attack on the ROK Ship Cheonan and the artillery firing at Yeonpyeong Island. As long as such threats continue, the main agents of the provocative acts, which are the North Korean regime and its military, will remain enemies of the South.

Second, ‘upholding the principle of peaceful unification’ means that the MND will contribute to peaceful unification of the two Koreas by deterring war, easing the military tension, and bringing permanent peace to the Korean Peninsula.

Third, ‘contributing to regional stability and world peace,’ based on the ROK’s national power and defense capabilities, entails that the MND will promote cordial and cooperative military relations with neighboring countries while actively participating in international peacekeeping activities.

## 2. Tenets of the National Defense Policy

With its vision, the development of an Advanced Elite Military, designed to meet the objectives of national security and national defense, the MND has come up with eight key tenets of the national defense policy<sup>1</sup> in order to ensure consistency in the policy implementation process.

**| Defense posture for comprehensive security |** The ROK military will prepare to take immediate action and conduct complete operations against any incidents no matter when, where or what situation occurs. It will also ensure an all-directional defense posture against all forms of threat, including the North, to realize comprehensive security.

To this end, the ROK military will firmly establish an all-directional defense posture to deter the North’s military provocations and to become victorious in any battle. In addition, the MND will develop an integrated defense posture that allows civilians, government, military and police to work together so that all of the nation’s capabilities can be fully synthesized during a national crisis or emergency.

The MND will adopt a rapid response posture and hone the capability to cope with transnational and non-military threats, including terror attacks and disasters, whenever they occur. In addition, it will establish a close collaborative base with the international community so as to share information and reinforce the joint response structure.

### 1. Eight Key Tenets of the National Defense Policy

- Defense posture for comprehensive security
- The development of the ROK-U.S. military alliance and expansion of defense diplomacy and cooperation
- Military support to advance inter-Korean relations
- Establishing advanced military capabilities
- Improving the cultivation, educational and training systems for defense personnel
- Enhancement of management efficiency
- Attractive military, rewarding military
- The armed forces serving the people

### | **The development of the ROK-U.S. military alliance and expansion of defense diplomacy and cooperation** |

The ROK and the U.S. will creatively develop a future-oriented alliance based on shared values, mutual trust, and the legitimacy of the alliance.

The scope of the ROK-U.S. alliance will broaden and deepen so as to cover cooperation on the political, economic, social and cultural fronts beyond military and security concerns. Furthermore, the two nations will foster the alliance in a way that contributes to regional and global peace and prosperity.

The United States Forces in Korea (USFK) will be guaranteed stable stationing conditions, and the ROK and the U.S. will invigorate policy coordination to solidify their mutual trust. The two nations will also create a new alliance military structure that takes into account the aftereffects of wartime OPCON transition.

Based on the ROK-U.S. alliance, the MND will enhance its cooperative military relationship with neighboring countries, expand its military diplomacy to the global level and bolster international peacekeeping operations. While pushing ahead with pragmatic, future-oriented defense diplomacy, which contributes to national interests, the MND will take active part in internationally directed operations to stabilize the countries under conflict and to support reconstruction in the strife-ridden areas.

### | **Military support to advance inter-Korean relations** |

The MND will take military assurance measures in a timely manner in accordance with the development of the inter-Korean exchanges and cooperation, while developing and implementing creative agendas and strategies to relieve military tension and to build trust with North Korea.

While providing military assurances for inter-Korean exchanges and cooperation, the MND will maintain a solid military readiness posture. The Ministry will also build military trust and pursue step by step measures in arms control to allow peace to take root on the Korean Peninsula.



The ROK ship Munmu the Great of the Cheonghae Unit escorting a merchant vessel (the Gulf of Aden, April 2009)

Given that the issue of ROK POWs, together with the inter-Korean joint search mission for remains of those killed during the Korean War, has to be addressed as a matter of national responsibility, relevant action plans and negotiations with North Korea must be conducted with the concerted effort through inter-agency coordination.

**| Establishing advanced military capabilities** | In order to effectively cope with the strategic environment and the possible warfare scenarios of the 21<sup>st</sup> Century, the MND will shift the ROK military structure to one that is more information and technology-intensive.

The MND will progressively complement the Defense Reform Basic Plan considering the changes in the security circumstances and the financial support plan of the Government. In addition, when reevaluating the current and future threats, the MND will reshuffle the military structure to enable the military to proactively respond to the changing security environment, while developing the structure as a tailored unit befitting the varying operational conditions that characterize the Korean Peninsula. A jointness-based, top-down chain of command will strengthen the nation's military power, thereby improving the efficiency of its force structure. In terms of the reserve forces, the mobilization system will be innovated and the education and training systems will also be meliorated to enhance their combat capability to the level of the standing forces.

**| Improving the cultivation, educational and training systems for defense personnel** | Based on an efficient military personnel recruiting and managing system, the MND will improve the education system for officers and working conditions for career service members so as to foster an elite defense workforce capable of meeting the challenges of future warfare.

In addition, the MND will align the current training programs for officers to secure elite defense human resources that are suitable for a technology-intensive military structure, while improving the educational system for officers in a way that reinforces the efficiency and jointness of the military. In order to prevent the possible weakening of force levels attributed by

the shortened military service period for enlisted service members, boot training as well as the general training systems will be reinforced to ensure the existing combat forces are primed to their optimal level. The MND will also introduce a technologically advanced security system in phases and expand outsourcing, thus reducing the cost and workload pertaining to security and unit management and creating an environment that allows the military to focus on education and training.

In terms of the mental strength education system, the military will invigorate these kinds of routine training focused on the internalization of the military spirit and duties as a way of life. At the same time, together with other appropriate government agencies, the MND will establish a ‘public security education network’ to help the public to share a sense of national security.

**| Enhancement of management efficiency |** The MND will enhance defense resource management by improving colligation, adjustment and control of goods and services in the military. The Ministry will not only improve efficiency in the national defense architecture and management but will also maximize the functional contributions of the defense industry and defense budget to the national economy.

The MND will improve the national defense managerial system to enhance organizational and human resources management, while promoting transparency and efficiency in the contract system regarding military supplies and facilities. In addition, it will reduce supply expenditure to a minimum through a military supply policy grounded on the Total Life Cycle Systems Management (TLCSM). The MND will also optimize the nation’s defense resources by preventing overlapping investments in the national budget and maximizing the use of good-quality resources from the private sector. It will improve the weapon procurement and acquisition system and promote the defense industry as an exporter through its enhanced capabilities in the defense science and technology area. In this way, the national defense economy will become a growth engine for the national economy.



The Vice Minister of Defense inspecting the status of a K-series tracked vehicle for an efficient defense budget plan (20<sup>th</sup> Division of the Army, September 2010)

**| Attractive military, rewarding military |** The MND will make the military attractive and rewarding by ensuring the service period is spent productively and rewardingly by combining its physical and mental training, including training to promote a collective spirit.

The Ministry will also train newly enlisted service members to become strong warriors and, on the other hand, provide self-development programs that will allow them to earn college credits or certifications, thus making military service more holistically productive. Besides, the MND will renovate the current narrow and old living quarters to provide a pleasant environment thereby enhancing the service members' quality of life.

The Ministry will upgrade the military medical support system in order to enhance the health and combat capability of soldiers and will implement the Basic Military Welfare Plan to heighten the career soldier's quality of life.

**| The armed forces serving the people |** The MND will enable the armed forces to focus on their original missions and strengthen their ability to garner the trust of the nation, guarantee people's convenience, and realize government policies to firmly establish the image of the 'citizen in uniform.'



Joint Burial Ceremony for the Korean War KIA's (Seoul National Cemetery, December 2009)

The disaster relief system will be improved and the rules and regulations imposed by the military eased to enhance the benefits to the public and protect its rights. Especially, in case of disaster, the MND will provide active support for disaster-stricken civilians to assure their survival and reduce their hardship. The MND will mitigate the regulations over the Military Installation Protection Zones to an extent to which military operations are not hampered.

As for the military service and conscription system, the MND will improve the system to better utilize the nation's human resources and ensure the principle that every man of fit body and mind, no matter his social background, shall fulfill his military duty without exception.

At the same time, the MND will expand the compensation and honor benefits for those service members and their families, who sacrificed themselves for the nation, while exalting their spirit of self-sacrifice. In addition, the Ministry will reinforce its promotional efforts for the national defense policy and will solidify its relations with the public, the national assembly and the media, thereby expanding its support base. It will also strive to achieve a 'fair military' in line with the Government's campaign to make a 'fair society.' The Ministry, in line with this objective, will adhere to the principles of 'more autonomous and creative defense'; 'a fairer military'; and 'a military that fulfills its social responsibilities,' when selecting its new policy agenda items.

# Chapter 3

## Defense Posture for Comprehensive Security

Section 1. All-Directional Military Readiness Posture

Section 2. Integrated Civilian-Government-Military-  
Police Defense Posture

Section 3. Development of a Readiness Posture  
against Transnational and Non-military  
Threats

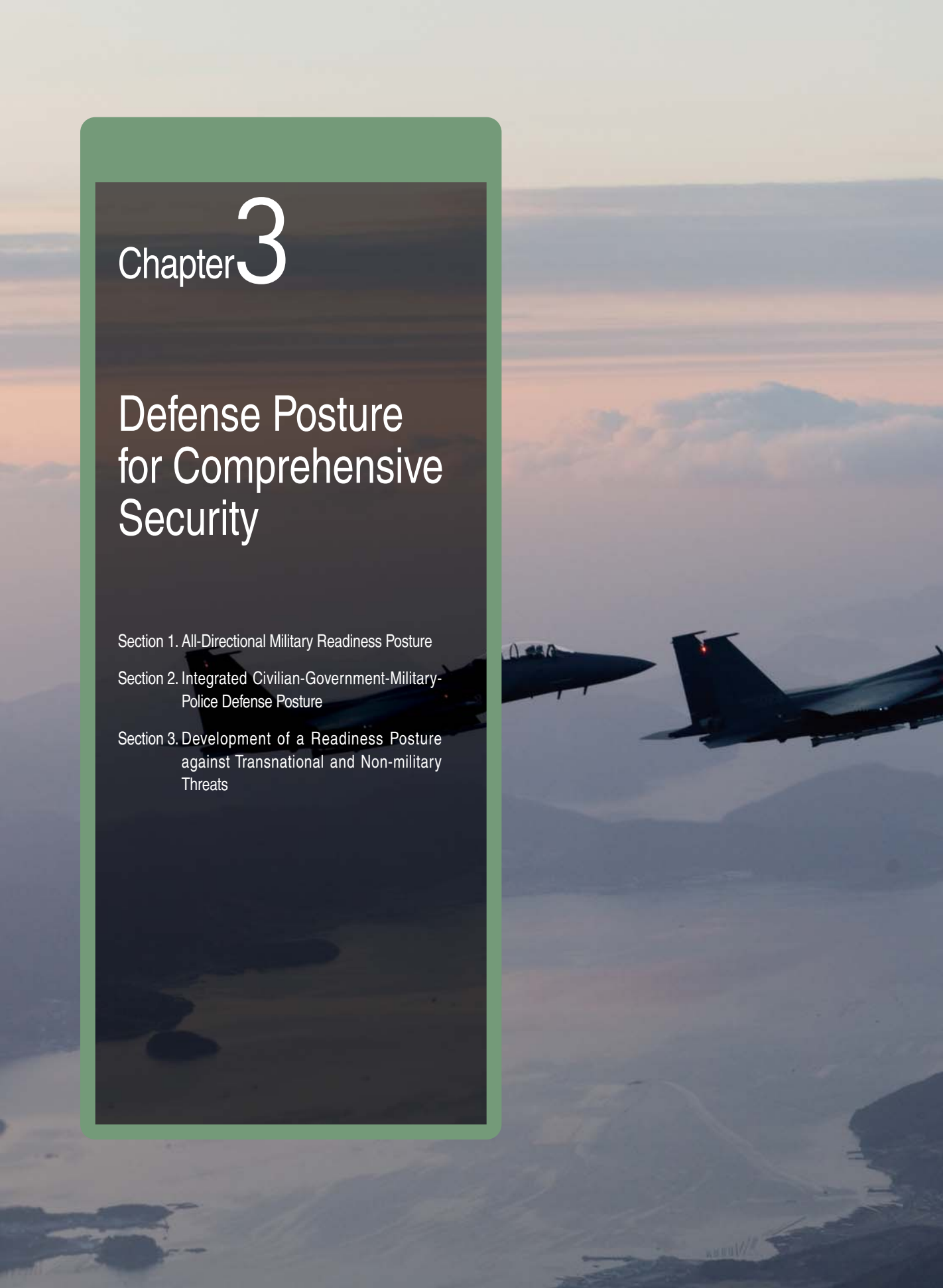





# Section 1

## All-Directional Military Readiness Posture

The ROK forces has been supplementing its military readiness posture in consideration of the diverse and complex threats from North Korea. The priority, in the complementation process, is given to the weak areas of the combat power in current operation to maximize the operational efficiency of the existing forces. In addition, the military maintains a firm military readiness posture based on the ROK-U.S. combined defense posture.

### 1. Military Organization and Retaining Forces

**Reinforcement of the Joint Chiefs of Staff** | The Joint Chiefs of Staff (JCS) is comprised of a vice chairman, three Central Directorates and four Offices as shown in Figure 3-1. The responsibility of the JCS is to carry out joint and combined operations by conducting operational command, supervising the operational units of each troop and orchestrating joint units.<sup>1</sup>

In preparation for the Wartime Operational Control (OPCON) transition and to subsequently establish the ROK forces-led war-fighting system, the JCS has expanded and reshuffled its organizational and command structure so as to simultaneously manage, under a unified command, all elements of theater operation on the Korean Peninsula. From this time forward, the JCS will establish a joint combat development system<sup>2</sup> and construct a task performance system, if needed, which reinforces the jointness<sup>3</sup> of combat units. In addition, until 2015, it will evolve a cooperative body that helps sustain the close ties between ROK JCS and U.S. KORCOM, while strengthening its own organization.

#### 1. Joint unit

A unit that is comprised of two or more Services.

#### 2. Joint combat development system

A rational and scientific system that strengthens jointness and generates the requirements for the future development of military strength.

#### 3. Jointness

The unified management of the military forces and the activities carried out by each of the services towards maximizing the synergy between the services that comprise the combat strength and ensuring victory in war.

Figure 3-1. Organizational Chart of the Joint Chiefs of Staff

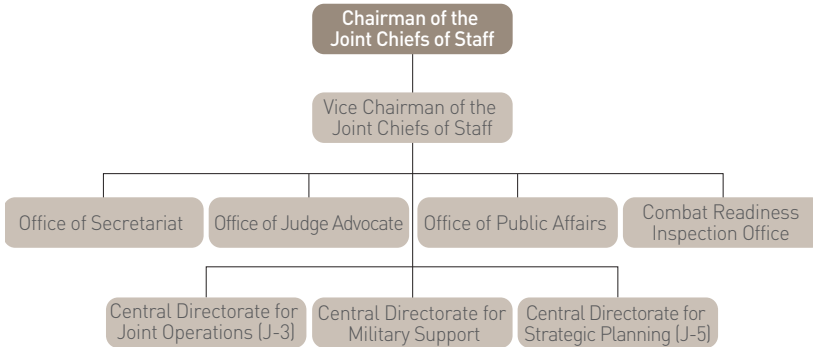

\*Effective on January 1, 2011

**Organization of individual Services and retaining forces |**  
**The Army** is organized into the Army Headquarters (HQ), two Field Army HQs, one Operations Command, the Capital Defense Command, the Special Warfare Command, the Army Aviation Operations Command, the Army Missile Command, and other support units. Its organizational chart and retaining forces are shown in Figure 3-2.

Figure 3-2. The ROK Army: Organizational Chart and Retaining Forces

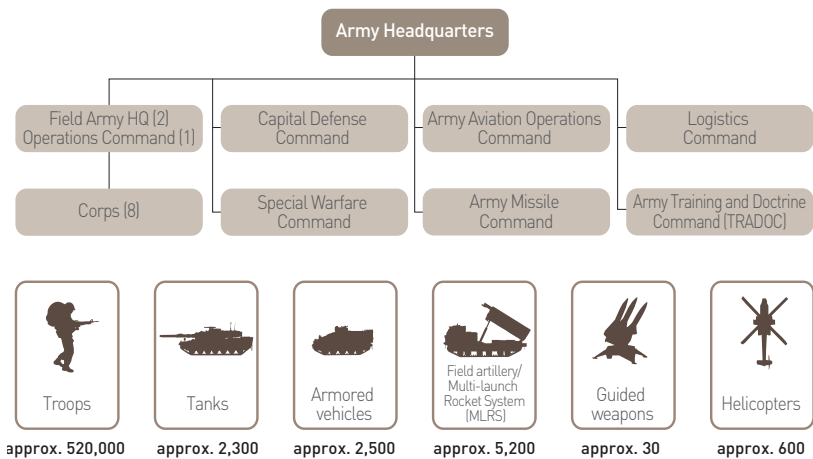

K1A1 Tank

The defense mission of the First and Third Field Army covers the area ranging from the Military Demarcation Line (MDL) to the frontline area of responsibility (AOR). The Second Operations Command maintains stability in the rear areas and war sustainability. The Capital Defense Command is responsible for protecting the capital area, which includes maintaining the functions of Korea's capital, Seoul, and protecting major facilities in the area. The other units' missions are to carry out special warfare, aviations operations, logistical support, training and education, and others.

In the future, the Army will place priority on further reinforcing its military strength against possible infiltration and local provocations by North Korea, thereby maximizing its existing forces and, at the same time, attaining the ability for offensive maneuver warfare that will put into practice the joint operational concept. To this end, the Army will be equipped with surveillance · strike · maneuver forces by securing unmanned aerial vehicles (UAV), a multi launch rocket system (MLRS),<sup>4</sup> next-generation tanks (XK-2), and next-generation armored personnel vehicles.

The Navy is organized into the Navy HQ, the Naval Operations Command, the Marine Corps HQ and other support units. Its organizational chart and retaining forces are shown in Figure 3-3.

#### 4. Multiple Launch Rocket System (MLRS)

A launch system that has numerous rocket ammunition arranged in a box-like or cylindrical shape. It is a weapon that concentrates massive synchronized firepower and is typically mounted on and operated from a vehicle.



ROKS Yulgok Yi Yi (Aegis destroyer)

Figure 3-3. The ROK Navy: Organizational Chart and Retaining Forces

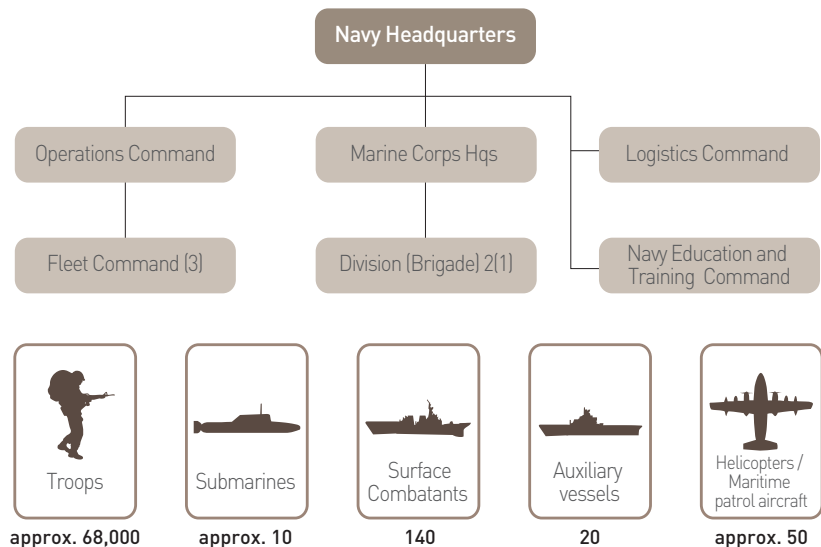

The Naval Operations Command leads overall naval operations, while conducting anti-surface ship operations,<sup>5</sup> anti-submarine operations,<sup>6</sup> mine operations,<sup>7</sup> and amphibious operations. The Fleet Command carries out defense of the sea areas for which it is responsible by employing surface combat ships, including destroyers, frigates, patrol combat corvettes (PCC), and high-speed craft.

The Marine Corps HQ is in charge of amphibious operations and defending the western section of the Greater Seoul Metropolitan Area (GSMA) and the Northwest islands. The other units provide logistics support and education and training.

In the future, the Navy intends to first address its weaknesses in light of the lessons learned from the ROKS Cheonan incident, and as one pillar of the joint forces, it will develop a force structure capable of performing three dimensional (land, sea and air) missions carried out under water, on the water and in the air. To this end, it will procure new detection radars, maritime operation helicopters, Aegis destroyers,<sup>8</sup> and next-generation frigates (FFX), next-generation patrol craft (PKX) and next-generation submarines. The Marine Corps HQ will be further developed as a flexible force structure that can be easily realigned depending on the circumstances and missions, such as three-dimensional, high-speed amphibious operations, rapid response operations, and ground operations.

The Air Force is organized into the Air Force Headquarters, the Air Force Operations Command, and support units. Its organizational chart and retaining forces are shown in Figure 3-4.

**5. Anti-surface ship operations**

Operations intended to secure or maintain control of the seas or to destroy or incapacitate an enemy's surface forces through the use of surface combat ships, submarines and aircraft.

**6. Anti-submarine operations**

Operations to ensure free use of the seas by destroying or neutralizing the enemy's submarines.

**7. Mine operations**

Operations whereby the enemy's naval forces are blocked or neutralized by using mines or where the enemy's use of mines is denied.

**8. Aegis destroyer**

A naval vessel whose superiority is unmatched and that stands head and shoulders in defensive power above any other type of surface combatants. In particular, it has the ability to detect, track and strike at several hundred enemy aircraft and naval vessels simultaneously.

Figure 3-4. The ROK Air Force: Organizational Chart and Retaining Forces

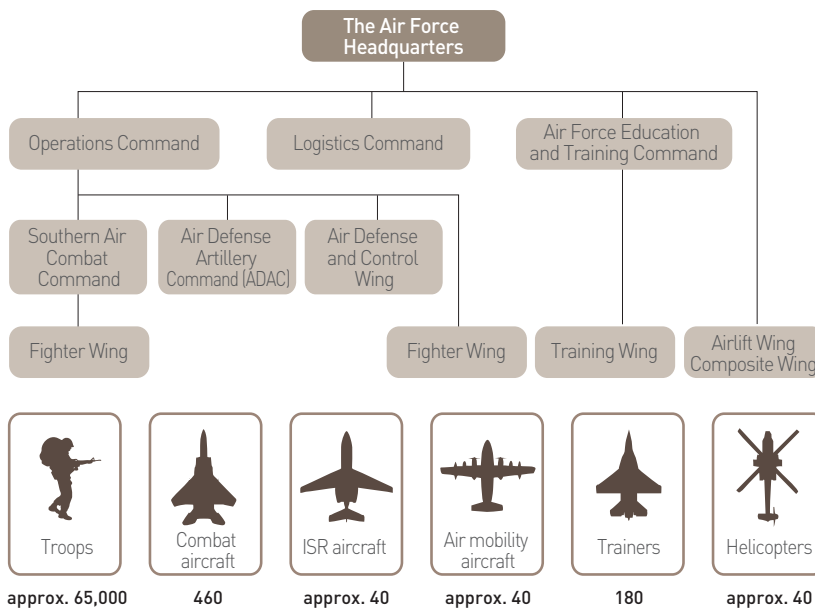

F-15K

**9. Counter air operations (CA)**

Operations that destroy or neutralize the aerospace power and air defense systems of an enemy in order to secure and maintain air superiority.

**10. Strategic attack operations (SA)**

Operations that destroy the enemy's will to engage in war by striking at its core strategic targets.

**11. Air interdiction operations (AI)**

Operations that block, disturb, delay, or destroy the enemy's potential military forces. This therefore limits an enemy's reinforcement of its forces, re-supply of its troops and the reinforcement of its mobility, before the enemy's forces can be effectively used against the ROK Army and Navy.

**12. Close air support operations (CAS)**

Operations that attack enemy forces that confront allied troops at close range, creating favorable operational conditions for the ROK Army and Navy, or which support the operational goals and survival of the ROK Army and Navy.

The Air Force Operations Command, as a centralized power, controls air operations, while carrying out counter air operations,<sup>9</sup> strategic attacks,<sup>10</sup> air interdictions,<sup>11</sup> and close air support operations.<sup>12</sup>

The Southern Air Combat Command, under the command of the Air Force Operations Command, performs decentralized missions under the centralized control of the operations command in order to defend the territorial spaces for which it is responsible.

The Air Defense Artillery Command (ADAC) carries out all-directional air defense missions against enemy aircraft, missiles and other aerial attacks. The other units provide logistical support, education and training.

The Air Force will develop into an aerospace force that will have the ability to perform long range operations, as well as to display air superiority and the ability for precision strikes. For this purpose, the Air Force will procure next generation fighters (Korea fighter jets), the Airborne Warning and Control System (AWACS), air refuelers, surveillance and reconnaissance systems, and ballistic missile defense systems.

**| United States Forces in Korea (USFK) and reinforced forces** | The USFK Headquarters consists of the Eighth U.S. Army (EUSA), the U.S. Naval Forces-Korea (CNFK), the Marine Forces-Korea (MARFORK), the Special Operations Command-Korea (SOCK), and the U.S. Air Forces-Korea (USAFK). The USFK Commander serves as both the Commander of the United Nations Command (UNC) and the Commander of the ROK-U.S. Combined Forces Command (CFC). Its organizational chart and retaining forces are shown in Figure 3-5.

Figure 3-5. The USFK: Organizational Chart and Retaining Forces

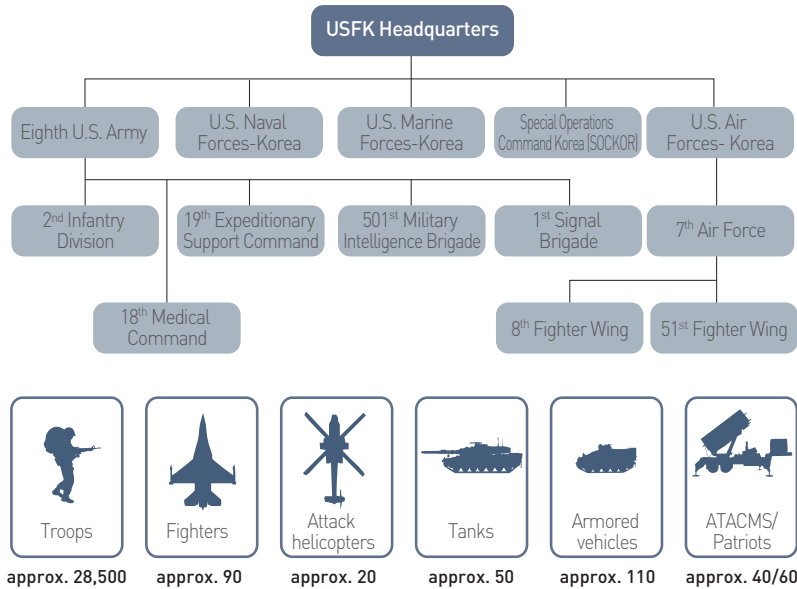

The reinforced forces of the United States, which would support the ROK in carrying out defense missions in the event of a war, consists of approximately 690,000 troops, 160 naval vessels, and 2,000 aircraft when Army, Navy, Air Force and Marine Corps forces combined. Depending on how a crisis unfolds, the U.S. reinforced forces will act in one of the following three ways: Flexible Deterrence Option (FDO), Force Module Package (FMP), and Time Phased Force Deployment Data (TPFDD).<sup>13</sup>

The FDO is the diplomatic, intelligence, military and economic option to be implemented for the purpose of deterring war – should it appear imminent – and it is comprised of approximately 130 items. The FMP refers to the major combat units and support units that will be reinforced in the early phase of a war should the efforts to deter the war fail. Included in the FMP reinforcements are major forces, such as immediate deployment aircraft and the aircraft carrier battle group.

### 13. Time Phased Force Deployment Data (TPFDD)

The type and specifications of the units to be deployed to augment U.S. troops as part of the operational plans of the ROK-U.S. combined forces.

## **2. Military Readiness Posture**

### **| Establishing early warning and crisis management systems |**

The ROK military maintains 24-hour surveillance and an early warning system over the Korean Peninsula and its adjunct islands including North Korea. For this purpose, the ROK military operates ROK-U.S. combined intelligence assets, including signal and imagery assets and satellites, which maintain a combined intelligence and surveillance posture. In addition, the ROK and the U.S. identify and evaluate any signs of threat.

The ROK Ministry of National Defense (MND) has in place the plans of action against diverse types of threats and a crisis management system for effectively dealing with different types of crises. In particular, since the attack on the ROK Ship Cheonan, it has supplemented its initial action manual, including the situation report and dissemination system, and the operational system in general.

The ROK and the U.S. now maintain an organic and close coordination structure to jointly manage crises through revisions of the integrated Crisis Action Standard Operating Procedures (CASOP); training their troops for combined crisis management exercise; and enhancing interoperability of Command, Control, Communications, Computers, and Intelligence (C4I) operations.

### **| Maintaining readiness posture against infiltration and local provocations |**

North Korea continues to trespass over the Northern Limit Line (NLL) in the West Sea: the North has fired at ROK patrol boats that were conducting no more than their routine assigned patrols; it unlawfully fired a torpedo at a ROK patrol ship and sunk a ROKN PCC; and it fired artillery at Yeonpyeong Island.

The ROK military has been supplementing its readiness posture and reinforcing practical training in consideration of the diverse types of provocations by North Korea. The ROK military will respond sternly to further provocations by North Korea pursuant to the Rules of Engagement and the SOP so as to swiftly end the operation on-the-scene and prevent the possible spreading of armed confrontations. The ROK military establishes a systematic operational posture, which allows it to respond in a foolproof manner to any provocations whenever and wherever they may occur.



The ROK military has deployed troops on the spot at all times in the northwestern waters so that it can maintain an operational readiness against North Korean provocation and provide a strong and instant response by the joint forces should such a provocation occur. In the Demilitarized Zone (DMZ) and other vulnerable areas, the military has been developing a security system based on scientific surveillance equipment in order to strengthen its security posture in those areas. In addition, to provide military assurance for inter-Korean exchanges and cooperation projects, it has been maintaining an immediate operational response posture against all possible contingencies in the South-North Joint Administrative Area in the East and West Seas.

The ROK military also maintains a complete readiness posture to firmly safeguard the ROK's territories, which range up to the northwestern five islands and the territories in the East, West and South Sea areas, including Marado, Ulleungdo and Dokdo.

**| Establishing readiness posture against an all-out war |** In preparation for North Korean armed provocations, the ROK-U.S. Combined Forces has strengthened the ROK-U.S. intelligence collaboration system and maintained early warning and joint crisis management systems that enable 24-hour surveillance of the entire Korean Peninsula through integrated management of their combined assets.

In the event that North Korea provokes a war, the ROK and the USFK will deny surprise attack through the ROK-U.S. Combined Early Warning System and rapid response measures. The ROK-U.S. Combined Forces maintains a complete readiness posture against an all-out war, which allows for the safeguarding of the Greater Seoul Metropolitan Area and seizing the initiative of the war within the shortest time possible by making precision strikes against the North's core forces, such as its long-range artillery and missiles.

For this purpose, the ROK-U.S. Combined Forces have established doctrines that maximize its performance in combined and joint operations and are regularly implementing realistic combined and joint training and exercises. The Joint Chiefs of Staff have established a JCS operational support plan to ensure the implementation of its combined operational plans.

## The territory of the Republic of Korea



\* Source: National Geographic Information Institute

### 3. Establishing Rapid Response Mobilization Posture

Mobilization<sup>14</sup> capability refers to the efficient organization, regimentation and unification of the nation's available human, material, and other resources towards achieving the goals of war; it is an essential factor in meeting the necessities of war and ensuring war sustainability. Therefore, the ROK Government maintains an immediate mobilization posture in order to be able to efficiently mobilize the nation's available resources in times of war.

**| Personnel mobilization** | Personnel mobilization is divided into the following three: manpower mobilization to supply the troops needed by military units; 'wartime labor service mobilization' to secure the personnel needed to support military operations; and 'technician mobilization.'

'Manpower mobilization' refers to the mobilization of reserve forces and their use as combat personnel by military units as required for the expansion (reinforcement or establishment) of military units or for replenishing losses. The MND designates and manages elite personnel to engage an enemy in a timely manner in times of war. With respect to each unit's mobilization requirements, the ROK military, as a priority, designates first year to fourth year military personnel of optimum specialties for optimum positions<sup>15</sup> and similar specialties,<sup>16</sup> and the resources are efficiently managed through the Defense Mobilization Information System. If the laws are amended so that partial mobilization is possible during peacetime, it is expected that economic losses due to the declaration of the mobilization order may be reduced, and the military may secure sufficient time to prepare for a battle.

Wartime labor service mobilization refers to the mobilization of labor resources for damage recovery and the transportation of supplies and ammunitions. The eligible conscripts are those persons in replacement service status and those in of 2<sup>nd</sup> conscription status,<sup>17</sup> excluding conscripts' eligible for manpower mobilization, and the MND preferentially designates replacement services personnel to be converted to combat personnel when needed.

#### 14. Mobilization

The Government's general activities to efficiently manage and control national resources, such as human resources, material resources, goods and services, during wartime or in a national emergency equivalent to a war.

#### 15. Military Optimum Specialty in Optimal Position

The same specialty as that required in mobilization.

#### 16. Similar Specialty

A specialty similar to that required in mobilization; when there is an insufficient number of resources that are categorized as being the optimum specialty for an optimal position, a specialty in a similar area is designated instead.

#### 17. 2<sup>nd</sup> conscription

Citizens who have been determined unable to serve in active duty or replacement duty as a result of their physical examinations, but who can perform military operational support services when wartime labor service mobilization takes place.

Technician mobilization refers to the mobilization of licensed or qualified technicians in the technical and specialized areas where active soldiers or mobilized forces are not able to perform duties or where the available resources are insufficient. The mobilized persons operate or maintain equipment used for combat or combat service activities. The MND cooperates closely with the Ministry of Public Administration and Safety and local government administration offices so that licensed technicians in new technology and information service areas can be mobilized.

**| Mobilization of materials |** Mobilization of materials satisfies the requirements of military operations and maximizes war sustainability by the timely allocation of resources, including materials, equipment, facilities and suppliers, where needed. It is broken down into the mobilization of industry, transportation, construction, and communications. In collaboration with the Ministry of Public Administration and Safety, the MND verifies the effectiveness of the Chungmu Plan through actual training in the areas of technical manpower, vehicles, construction equipment, and communications mobilization during the Chungmu exercises held every year.

Industrial mobilization refers to the conversion of industry to a wartime industrial structure in order to meet wartime needs, and the control and operation of some part of the manufacturing, repairing, processing and distribution processes by mobilizing materials and providers in certain businesses. In the future, during Chungmu training, the MND plans to gradually augment the manufacturing training for those suppliers subject to the mobilization of vehicles/construction equipment and industrial mobilization so that they will be well-versed in their wartime mission procedures. Furthermore, it plans to identify and designate the civilian items for mobilization, which are also compatible for use by the military. The designated civilian items are shown in Table 3-1.

Table 3-1 Civilian Items Designated for Mobilization

Unit: EA.

Classification	2008	2009	2010
Number of Items	379	385	365

Transport mobilization refers to the temporary mobilization of land, water and air transport vehicles and equipment, or the control and operation of part of a business engaging in such transport activities, when required for military operations. A region that is deficient in transport mobilization resources satisfies its mobilization needs by designating the excess resources of nearby cities and provinces.

Construction mobilization refers to the mobilization of buildings, land, construction equipment, maintenance service providers and construction companies, among others. In order to shorten mobilization time, the MND has designated and managed the latest equipment, wheeled mobile equipment, and equipment in neighboring areas of the unit in need as the supplies for initial mobilization. In the future, for wartime use, it plans to designate civilian service providers for mobilization, in order to outsource repair and transport units managed in accordance with the civilian outsourcing expansion plan.

Mobilization of communications refers to the mobilization of the communications line services and telecommunications companies, software businesses, and knowledge and information security consulting businesses that are necessary for military operations. The MND is extending the scope of its mobilization designation to include civilian broadband service providers, IT companies, and knowledge and information security consulting businesses, in order to secure smooth command, control, and communications capabilities during wartime.

**| Ensuring timely mobilization** | The timing of a declaration of the mobilization order will be decided in consideration of the initial operational capability, combat sustainability, and the national economic cost for declaring the national mobilization order. Timely mobilization can minimize economic cost, while being an integral element in preparation for combat in the early phase of war. In this regard, the MND has been pursuing an initiative to allow for earlier declaration of the mobilization order which, however, will be first confined to the partial mobilization of those forces that are most needed.

Accordingly, the MND plans to improve the current mobilization system, where mobilization is possible only in wartime, so that mobilization is possible for designated resources and in designated areas even in peacetime. First of all, this will be reflected in the National War Guidelines or the Chungmu Basic Plan to ensure swift expansion of combat units in the early phase of a war and flexibility in the management of the reserve forces. To put this into law, the MND is modifying the statutes related to mobilization.

# Integrated Civilian-Government-Military-Police Defense Posture

Amid the persistent threat from North Korea, transnational and non-military threats are on the increase. Against these threats, the integrated efforts and actions of the civilian-government-military-police entities are of utmost importance. Accordingly, the MND has continually endeavored to establish an integrated civilian-government-military-police defense system and an integrated defense operational posture by amending the relevant laws and taking the necessary measures.

## 1. Integrated Defense System

Since 1995, when the municipality system was implemented, the ROK Government has been developing the Integrated Defense System by expanding the role and function of local governments with respect to homeland defense.

The Integrated Defense System, including the Integrated Defense Headquarters as its primary element, is comprised of the following national defense elements: the Central Integrated Defense Council, the Regional Integrated Defense Committee, the Integrated Defense Supporting Headquarters, and others including regional military commanders, provincial police agency, and National key facilities.<sup>1</sup> The command and cooperative structure, under the Integrated Defense System, is shown in Figure 3-6.

### 1. National key facilities

Facilities that will have a significant impact on national security and the lives of citizens if they are captured, destroyed or neutralized, e.g., public institutions, airports, harbors, and military-related transportation facilities

Figure 3-6. Integrated Defense Command and Coordination Structure

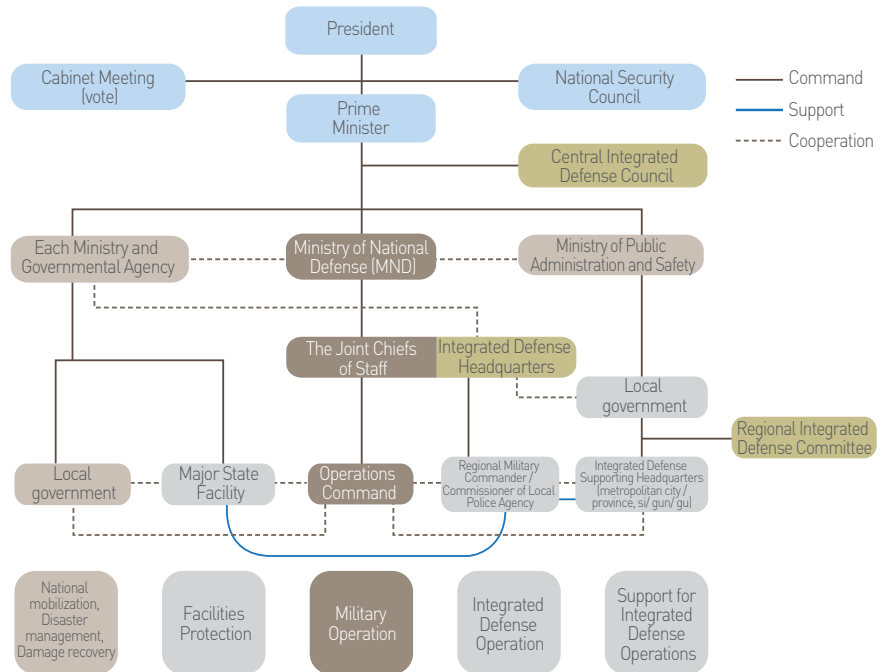

The Integrated Defense Headquarters is the supported organization for integrated defense missions and is chaired by the Chairman of the Joint Chiefs of Staff. The Integrated Defense Headquarters perform the following functions: formulating and coordinating integrated defense policies; ascertaining and supervising an integrated defense posture; conducting general analyses of situations and establishing counter-measures for integrated defense operations; establishing operational and training plans for integrated defense and coordinating and controlling the execution thereof; supporting organization related to integrated defense; and discussing and coordinating the execution of their businesses.

Integrated Defense Supporting Headquarters are present in each metropolitan city / province, si (city) / gun (county) / gu (district), and eup (town) / myeon (village) / dong (division within a district). The Integrated Defense Supporting Headquarters perform the following functions:



establishing the ordinances and rules for integrated defense centered on local governments; establishing and implementing plans for the support of integrated defense operations and training; installing and operating integrated defense situation rooms; promoting and providing support for national defense elements, including the military, police, reserve forces, local governments and civil defense corps; and establishing resident reporting systems regarding suspicious activities, or persons, in vulnerable areas.

The Central Integrated Defense Council is the highest decision-making organization regarding integrated defense and was established under the Prime Minister's Office. It deliberates and votes on integrated defense policies, provides guidance to integrated defense operations and training, and is involved in the declaration and lifting of an integrated defense condition.<sup>2</sup>

The Regional Integrated Defense Committee is a regional integrated defense organization established in 16 metropolitan areas and provinces, including Seoul, and in 230 sis/guns/gus. It deliberates and votes on the following: integrated defense preparatory measures; the declaration and lifting of an integrated defense condition (Eul-type and Byeong-type); various supportive measures in the event of integrated defense operations or exercises; the designation and lifting of vulnerable regions; and the efficient promotion, management and support of national defense elements.

The regional military commander and the commissioner of the local police agency control the integrated defense operations. Upon declaration of an integrated defense condition, they are appointed operational commanders in order to implement the required integrated defense operations by integrating the national defense elements, such as the civil defense corps, the military, police, local government and homeland reserve forces, as well as key state facilities, and by unifying the command structure.

The ROK Government has established an integrated defense posture by holding central integrated defense meetings and regional integrated defense meetings once a year to evaluate the accomplishments of the measures being taken by the national and local governments concerning the integrated defense policies and measures and by seeking measures thereof when needed.

## 2. Integrated Defense Condition

A condition declared in phases against enemy infiltration, provocation or threats. This posture is divided into Gap-type, Eul-type, and Byeong-type and in metropolitan cities and provinces only the Eul-type or Byeong-type condition can be declared.

·Eul-type: Declared when an enemy has infiltrated or committed provocative actions in several regions at the same time, hence restoring security in a short period of time would be difficult, subsequent integrated defense operations must be carried out under the command and control of the regional military commander.

·Byeong-type: Declared when enemy infiltration or provocation is expected or there has been only small-scale infiltration, hence security may be restored within a short period of time with the implementation of integrated defense operations under the command and control of the local police commissioner, regional military commander or fleet commander.



Central Integrated Defense Meeting  
(Central Government Complex, January 2010)

## 2. Integrated Defense Operational Posture

The ROK Government maintains an integrated defense operational posture in order to prepare for enemy infiltration and provocations during peacetime and to carry out homeland defense operations in rear areas during wartime. Heads of local governments, as chairmen of the Regional Integrated Defense Committees, have the authority to declare an integrated defense condition through committee deliberation. Once the condition is declared, the commissioner of the local police agency or the regional military commander is appointed as operational commander in accordance with the laws and regulations relevant to integrated defense. The operational commander integrates all of the defense elements within the region and also unifies the Chain of Command so as to efficiently implement the integrated defense operations. The mayors of metropolitan area and the governors of provinces form the Integrated Defense Supporting Headquarters to support the integrated defense operations.

The ROK Government is making efforts to establish a watertight civilian-government-military-police integrated operational posture. It maintains the ability to swiftly deal with emergency situations through Integrated Defense Situation Rooms and has established a Wide Area Network (WAN) to develop information sharing systems where videoconferencing and interactive broadcasting between local situation rooms are available. The ROK Government has also drafted a diagram of the duties of the support team and the team members so that they become familiar with the measures and procedures to be taken in wartime. To enhance the protection of key state facilities, the self-protection plans for each facility have been improved and the surveillance assets, integrated situation rooms, and monitoring facilities reinforced. The managers of major state facilities are party to a monitoring agreement with the military and police and have developed integrated protection plans and strengthened training with regards to the facilities.



Inspection of underground conduit protection (May 2010)

The Integrated Defense Headquarters is improving its integrated defense training system in order to effectively deal with rising comprehensive security threats. The Integrated Defense Headquarters conveys training guidelines, while jointly organizing and managing an integrated observation group with the Government. The control and evaluation of the training is

delegated to each operations commander to provide the conditions whereby the subordinate units can establish and implement practical training that is appropriate for peacetime and wartime. Since 2009, through the Hwarang Exercise, the front area corps of the FROKA and TROKA, and local governments (the Integrated Defense Supporting Headquarters at the city/gun/gu levels), have also been improved so that they are familiar with the operations of the Integrated Defense Situation Room and the measures and procedures of the Integrated Defense Supporting Headquarters, in preparation for possible enemy infiltration or provocation.

Meanwhile, the MND is continuously revising the laws and regulations related to integrated defense. In December 1967, the MND enacted the Presidential Directive, Counter Espionage Measures, in order to effectively respond to the North's frequent infiltrations and provocations in the 1960s. In January 1995, it changed the name of the Directive to the Integrated Defense Guide. As a result of the Gangneung submarine infiltration incident in October of 1996, the Integrated Defense Act was enacted in January 1997 to provide the legal basis for integrated defense operations and the support thereof. Thereafter, the laws and regulations on integrated defense have undergone seven rounds of amendment to reflect the changes in the operational environment. In 2009, in particular, difficult terminologies were replaced with simpler alternatives and legal bases were provided for the security posture, integrated defense exercises, and an integrated defense posture centered on the heads of local governments.

### **3. Homeland Defense Operations Posture**

Homeland Defense Operations are civilian-government-military-police integrated operations that protect the areas of responsibility (AOR) by mobilizing reserve forces. These operations maintain stability in the rear areas by cracking down on armed infiltrators and special operations forces in the event of armed riots and to protect important facilities and lines of communication.

The reserve forces are currently going through an overhaul based on the Defense Reform Basic Plan in consideration of the number of reserve forces troops, the regional peculiarities, and future restructuring of the



Reserve forces in training with survival gear (March 2009)

administrative districts.

The MND executes realistic training of the reserve forces using advanced equipment, such as survival gear, to foster reserve forces with a combative mindset and capability. By doing so, the reserve force's ability to carry out Homeland Defense Operations, during peacetime and wartime, is being reinforced.

In addition, to enable effective responses to disturbances in the rear areas by enemy special operation forces, the MND has procured combat gear for homeland defense, while upgrading the weaponry used by the reserve forces on a yearly basis. The MND also maintains a homeland defense operations posture by securing combat gear and supplies and by seeking elite personnel for reserve forces.

# Development of a Readiness Posture against Transnational and Non-military Threats

The security environment today is characterized not only by traditional military threats but also increasingly diverse types of transnational and non-military threats. To effectively prepare for these new threats, the ROK military has equipped itself with immediate response capabilities and a readiness posture, while maintaining a close coordination system with the international community.

## 1. Maintaining Rapid Response Capabilities and a Readiness Posture

The ROK military maintains a firm readiness posture against the threat of North Korea, while being equipped with an efficient organizational and a mission procedural system through which it is able to respond immediately to terrorism, piracy at sea, cyber terror attacks, disasters and other transnational and non-military threats. The ROK military is also reinforcing its efforts to efficiently counter various types of threats by maintaining an information sharing system and engaging in joint exercises with concerned organizations.

The ROK military is enhancing the joint response capabilities of the government and military against Improvised Explosive Devices (IED),<sup>1</sup> which have resulted in a tremendous human death toll in several regions of the world; it is also expanding the various types of combined counterterrorism exercises, e.g., Foal Eagle. In addition, in 2010, the Anti-Terrorism Manual against Military Facilities was amended so that the counter-terrorism mission procedural system that describes the duties of each agency and its function was rearranged.

**1. Improvised Explosive Device (IED)**  
All types of improvised explosives formed by a combination of explosive parts that can be used for killing, destroying and attacks.

## 2. Distributed Denial of Service (DDoS)

Methods of hacking whereby a website is attacked by making several computers perform an action simultaneously.

The ROK military takes action against cyber terror attacks, which have been increasing in recent years, including the massive Distributed Denial of Service (DDoS)<sup>2</sup> attacks on the websites of ROK governmental bodies that occurred in 2009. In September 2009, the Comprehensive Defense Measures Against Cyber Crisis was established and a counter cyber attack command was created in January of 2010 to manage, in an integrated manner, any and all cyber threats against the national defense information systems.

In preparation for events, such as large scale disasters and unlawful strikes, which paralyze the nation's core infrastructure, the ROK military has been reinforcing its damage recovery support capabilities. In order to respond flexibly to each type and each stage of a disaster situation, the Manual for On-site Measures and Actions in the Event of Disasters and for Core Foundational Areas was updated in 2009. In addition, functional military personnel are being trained systematically through various types of training programs.

## 3. Safe Korea Exercise (SKX)

An exercise held every year, in which over 398 organizations and groups (central governmental agencies, local governments, public institutions, and other concerned organizations) participate, for the purpose of strengthening the disaster management system operations, inspections of the command structure, and civilian and governmental cooperation.

The National Disaster Management Information System was established for units at the battalion level and below, and the entire military participates in anti-disaster CPX, the military also maintains proficiency in the ability to respond to various situations by participating in the national level Safe Korea Exercises (SKX).<sup>3</sup>



Safe Korea Exercise (SKX) (Daegu, May 2009)

The MND drew up a 'Manual for Military Transport Aircraft Duties Related to the Government's Overseas Disaster Emergency Rescues,' which enabled governmental emergency rescue teams to use military transport aircraft for a rapid rescue operation when joining disaster recovery initiatives in overseas countries. In May 2010, a government simulation exercise was conducted pursuant to this manual so that the government-wide comprehensive performance abilities could be reviewed.

## 2. Maintaining a Close Coordination System with the International Community

Transnational and non-military threats are not only diverse in terms of by whom and how they are posed, but they are also broad in terms of their geographical reach, they spread at great speed, and it is difficult to predict when and how they will strike. Hence, there is a limit to what one country alone can do. In this regard, regional and international cooperation centered on international organizations, regional organizations and multilateral security consultative bodies is imperative.

The ROK military has participated in the efforts of the regional and international community against transnational and non-military threats. In March 2009, the ROK military dispatched the Cheonghae Unit to the Gulf of Aden where it continues to assist in the safe passage of South Korean ships, and it has been successfully carrying out anti-piracy operations. In November 2009, it also transported relief supplies to the Cambodia typhoon disaster area.



Cheonghae Unit rounds up pirates (Gulf of Aden, August 2009)



The Danbi Unit celebrates giving medical check-ups to over 10,000 local residents (Haiti, September 2010)

In February 2010, the ROK military dispatched the Danbi Unit comprised of over 240 troops, mostly from the engineering unit, to Haiti in order to assist in the disaster recovery efforts, and in July of the same year, it also sent 232 protection personnel to Afghanistan to ensure the safety of the Provincial Reconstruction Team (PRT) in Afghanistan.

In addition, the MND has actively participated in various types of discussions and training programs at the international level in order to enhance its joint response capabilities against transnational and non-military threats. In April 2009, the MND, together with Singapore's Ministry of Defense, jointly hosted the Defense official's Dialogue within the frame work of the ASEAN Regional Forum (ARF)<sup>4</sup> for parties to discuss their military's efforts in responding to cyber terror attacks and other transnational threats and the possible joint collaborative measures to be taken by the region's nations against aforementioned threats.

In October 2010, the 13<sup>th</sup> Annual Asia-Pacific Chiefs of Defense (CHOD) Conference<sup>5</sup> was held in Seoul. Co-hosted by the ROK and the U.S., this largest-ever conference of high-ranking officers in the history of the ROK military was attended by Chairmen of the Joint Chiefs of Staff level officers from 26 nations. In this Conference, various agendas, including

#### 4. ASEAN Regional Forum (ARF)

The main governmental level multilateral security consultative body, in which 26 countries from the Asia-Pacific region and the EU chair country participate. Overall regional security issues are discussed.

#### 5. The Annual Asia-Pacific Chiefs of Defense (CHOD) Conference

An annual conference to strengthen multilateral military collaboration at the senior level within the Asia-Pacific region. In odd years, the Conference is hosted by the U.S. alone whereas in even years it is co-hosted by a nation in the region and the U.S.



PKO and maritime security cooperation, were placed on the discussion table in the plenary session, bilateral and multilateral talks. State Parties to this Conference shared the necessity of a coordination system that can contribute to stability and peace in the region and reinforced military coordination between nations, thus exhibiting their commitment to active participation in the joint efforts of the region against security threats.

In the Philippines, during May 2009, the United States and the Philippines co-hosted the ASEAN Regional Forum's (ARF) first ever combined exercises for disaster relief. The ROK MND contributed military transport aircraft for the purpose of transporting ROK military medical personnel and 119 rescue teams from the National Emergency Management Agency and various types of equipment. It also intends to increase the scale of its participation in the second combined exercises for disaster relief to be held in Indonesia in March 2011.

At the Cobra Gold exercise that was held in Thailand, February 2010,<sup>6</sup> the MND sent a 2,600 ton landing craft and battalion-level troops, thus enhancing the performance of joint operations by the multinational coalition forces.

Aside from this, the MND, through regularly-held defense policy talks and other discussion sessions, shares with the defense authorities of other nations the information regarding security threats, while conducting combined exercises to gradually expand the scope of bilateral cooperation .

As transnational and non-military threats continue to escalate, the role of the military is expected to further increase. In step with this, the MND will continue to maintain a close mutually cooperative structure with the international community by actively and positively participating in bilateral and multilateral security cooperative activities.



ROK participants in the ARF disaster relief combined exercise (Philippines, May 2009)

#### 6. Cobra Gold exercise

Combined exercises that have been held every year, since 1981, for multinational peacekeeping operations. Multi-national forces, which have assumed authority delegated from the UN, engage in humanitarian and peaceful training. In these exercises, the forces are sent to the virtual nation of Arcadia in which an armed dispute has arisen, and they have to end the conflict and help stabilize the nation.



Marine Corps participating in the Cobra Gold exercise held in Thailand (Thailand, February 2010)



ROK-U.S. Combined Exercise 'Invincible Spirit' (East Sea, July 2010)

An aerial photograph of a fleet of ships, including several large destroyers and a smaller vessel, sailing in a line on a vast blue ocean under a clear sky. The ships are moving from the top left towards the bottom right, leaving white wakes behind them.

# Chapter 4

## The Development of the ROK-U.S. Military Alliance and Expansion of Defense Diplomacy and Cooperation

- Section 1.** The Development of a Future-oriented ROK-U.S. Military Alliance
- Section 2.** Adjustment of the Timing for the Wartime OPCON Transition and Building a New Alliance Military Structure
- Section 3.** Ensuring Secure Stationing Conditions for the United States Forces in Korea (USFK)
- Section 4.** Expanding the Boundaries of Defense Diplomacy and Cooperation
- Section 5.** Contributions to International Peacekeeping Operations

# Section 1

## The Development of a Future-oriented ROK-U.S. Military Alliance

Based on the traditionally friendly relations that have been maintained over the past 60 years, the ROK-U.S. Alliance has made contributions to ensure stability and peace on the Korean Peninsula and to increase national interest. The ROK-U.S. Alliance will, based on its shared values and trust, continue to develop into a comprehensive strategic alliance.

### 1. Development of the ROK-U.S. Alliance

The ROK-U.S. Alliance has steadily evolved in response to changes in the security environment and, over the past 60 years, has contributed to peace and security on the Korean Peninsula and in the Northeast Asian region.

Today, the world faces not only traditional military threats but also various types of security threats, including weapons of mass destruction (WMD), terror, natural calamities and disasters, climate change, and energy problems. The United States has been readjusting military strategy concept, as well as the structure and size of its military force, in order to effectively deal with such threats. In addition, the U.S. has been reinforcing cooperation with its allies in order to effectively respond to the complex and uncertain security environment that we currently face and may face in the future.

Korea has become one of the key nations of the international community from its economic development and the settlement of liberal democracy, and with this heightened national power, Korea is developing its comprehensive strategic alliance with the United States based on shared values and trust.

The two nations, Korea and the United States, are readjusting the ROK-U.S. Alliance in order to actively respond to the diverse types of security threats that may arise in the future. Under mutual agreement, the two nations are pursuing OPCON transition and USFK relocation. In the meantime, they are mutually cooperating in various areas, such as international peacekeeping operations (PKOs), stabilization and reconstruction operations, humanitarian assistance, and disaster relief.



ROK-U.S. Summit Joint Press Conference (Washington, D.C., June 2009)

The number of United States Forces in Korea (USFK) troops gradually scaled down from 37,500 in 2003 to 32,500 in 2004 and to 28,500 in 2007. At the end of 2008, it was expected that the number would be reduced to 25,000. However, at the ROK-U.S. Summit in April 2008, the leaders of the two nations agreed to maintain the number of troops at 28,500 and reconfirmed this agreement in April 2009 at the London Summit Talks.

Through such adjustments of the ROK-U.S. Alliance, the two nations have expanded the scope of their roles and cooperation in diverse areas, going beyond mere security issues, and have provided a foundation upon which their relationship can develop into a reciprocal and mature alliance.

## 2. The Future Direction of the ROK-U.S. Alliance

The two nations, the ROK and the U.S., share universal human values, such as liberal democracy, human rights, and a market economy. Further, based on a mutual trust and respect, they have developed a close collaborative structure for military and security issues. Today, the two nations are taking further steps to enhance mutual cooperation in the economic, social and cultural areas and are seeking to construct the alliance at bilateral as well as regional, and global levels.

In April 2008, the two nations agreed, through the Summit, to strengthen relationship into a 'Comprehensive Strategic Alliance in the 21<sup>st</sup> Century' that would contribute to peace and security at regional and global levels. On this basis, in June 2009, the two nations adopted the 'Joint Vision for the ROK-U.S. Alliance,' which provided the future-oriented blueprint for the development of the alliance.<sup>1</sup>

### 1. The Joint Vision for the ROK-U.S. Alliance

This is the strategic master plan that provides the blueprint for the future-oriented development of the ROK-U.S. Alliance. It lays out in detail the developmental goals of the strategic alliance in the 21<sup>st</sup> century as well as the direction for future cooperation at bilateral, regional and global levels.



ROK-U.S. Foreign and Defense Ministers Meeting (Seoul, July 2010)

In the 'Joint Vision for the Alliance of the ROK and the USA,' two countries laid out in writing that the two nations will continuously provide extended deterrence, including the nuclear umbrella of the U.S., thereby maintaining a strong combined defensive posture and that they will pursue firm peace on the Korean Peninsula, as well as peaceful unification of the Koreas, based on liberal democracy and a market economy. With respect to North Korea's nuclear weapons and ballistic missiles, the two nations agreed to maintain a close mutual cooperative structure under the principle of complete and verifiable abandonment thereof. In addition, the two nations agreed to engage in close talks to respond to global challenges, such as the proliferation of weapons of mass destruction (WMD), terror, piracy, organized crime and drugs, climate changes, poverty, infringement of human rights, energy security and contagious diseases.

At the ROK-U.S. Summit held in Seoul in November 2009, the leaders of the two nations agreed to hold a '2 plus 2 Talks,' and consequently, the ROK-U.S. Foreign and Defense Ministers' Meeting were held in Seoul for the first time in the history of the ROK-U.S. Alliance. Through this meeting, the two nations exercised a suppressive strategy against North Korea, in response to the attack on the ROKS Cheonan, in the diplomatic and defense arena, thereby firmly warning North Korea against additional provocative actions, in the following ways: strengthening the United States' independent financial sanctions against North Korea and holding massive ROK-U.S. combined maritime exercises. The two nations also discussed various means of enhancing cooperation between the ROK and the U.S., such as pursuing the ratification of the ROK-U.S. FTA within the year, making efforts regarding amendment to the Nuclear Energy Treaty, and advancing the alliance to a partnership so as to resolve regional and global issues.

In the future the two nations will develop the ROK-U.S. Alliance into a comprehensive strategic alliance to expand their common interests and to contribute to world peace; the two nations will also act to strengthen their cooperation with regional organizations or nations and thereby promote peace and prosperity in the Asia-Pacific region.



USS George Washington during ROK-U.S. Combined Exercises (East Sea, July 2010)

## Section 2

# Adjustment of the Timing for the Wartime OPCON Transition and Building a New Alliance Military Structure

The ROK and the U.S. have agreed to adjust the date for the OPCON Transition from April 17, 2012, to December 1, 2015. The two nations will construct a strong new combined defense system for post-OPCON Transition to replace the current combined defense system for the purpose of deterring war on the Korean Peninsula, national security and protection of the territory should a relevant event arise.

### 1. Operational Command (OPCOM)

The authority exercised by a commander to a subordinate unit in order to carry out an operational mission.

### 2. Operational Control (OPCON)

The authority delegated to a commander to carry out a mission or task as specified in an operational plan or operational order.

### 3. Nunn-Warner Amendment

This refers to the bill that contained the U.S. Congress' proposal regarding ROK-U.S. relations, which was added to an existing bill that had been submitted to Congress for approval of the U.S. defense budget and regulation of the number of troops for the years 1990-1991.

### 4. East Asia Strategic Initiative (EASI)

A report submitted to the U.S. Congress by the U.S. Department of Defense in compliance as requested under the Nunn-Warner Amendment (submitted on three occasions: 1990, 1991, and 1992).

## 1. Chronology of OPCON Transition 1950-2005

In July 1950, President Syngman Rhee handed over operational command<sup>1</sup> of the ROK military to the Commander-in-Chief of the United Nations Command (UNC), General Douglas MacArthur. This choice was inevitable in order to protect and defend the country from extreme crises during the Korean War. After the Armistice Agreement, the ROK and the U.S. agreed to keep the ROK forces under the UN Commander's operational control<sup>2</sup> to ensure the UNC's commitment toward defending the ROK. With the establishment of the ROK-U.S. Combined Forces Command (CFC) in November 1978, operational control was transferred from the UN Commander to the CFC Commander.

Discussions regarding the return of OPCON began in August 1987, when the then Presidential candidate Roh Tae-woo proclaimed 'OPCON Transition and relocation of the Yongsan garrison' to be his campaign pledge. The matter of returning OPCON was also discussed in the U.S. through the Nunn-Warner Amendment<sup>3</sup> and the East Asia Strategic Initiative<sup>4</sup> (EASI, 1990-1992). As a result, the two nations began to pursue research and consultations regarding OPCON Transition in earnest.



During the 13<sup>th</sup> ROK-U.S. Military Committee Meeting<sup>5</sup> in November 1991, the two nations agreed to return peacetime OPCON to the ROK between 1993 and 1995 and to discuss wartime OPCON Transition after 1996. In accordance with, peacetime (or during armistice) OPCON was transferred to the Chairman of the ROK Joint Chiefs of Staff (JCS) at the end of 1994. Currently, the CFC Commander exercises wartime OPCON as well as Combined Delegated Authority.<sup>6</sup> The evolution of operational control is shown in Figure 4-1.

Figure 4-1. Changes in Operational Control

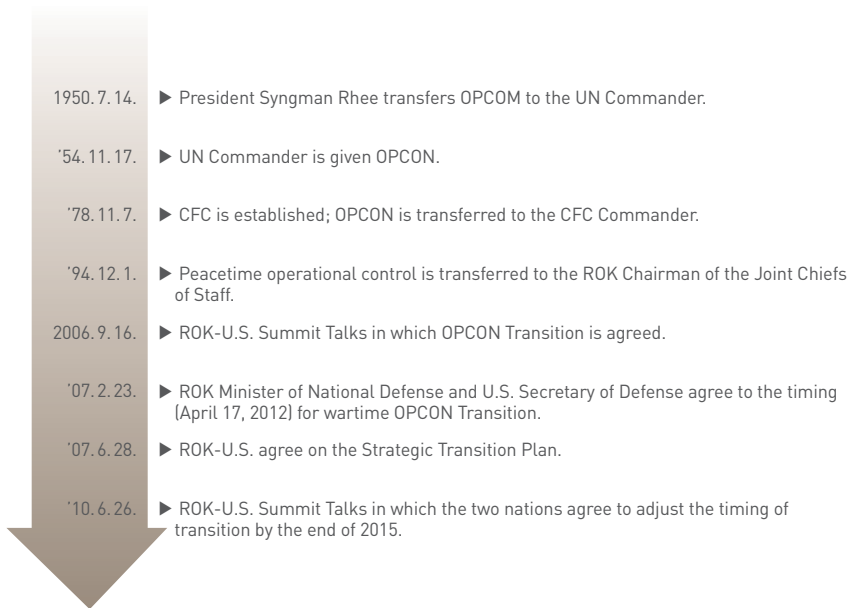

## 2. Wartime OPCON Transition Timeline 2005-Present

Since the ROK Minister of National Defense and the U.S. Secretary of Defense agreed to 'appropriately accelerate discussions on wartime OPCON Transition' during the 37<sup>th</sup> ROK-U.S. Security Consultative Meeting (SCM) in October 2005, the discussions have gained momentum.

During the ROK-U.S. Summit in September 2006, the two Presidents agreed to the basic principle that Wartime Operational Control (OPCON) would, indeed, be transferred. At the 38<sup>th</sup> SCM in October of the same year, the two heads of national defense agreed on the 'Roadmap for the New

## 5. ROK-U.S. Military Committee Meeting (MCM)

The highest body for military cooperation between the ROK and the U.S. and in which the Chairman of the Joint Chiefs of Staff and the senior general and flag officers participate.

## 6. Combined Delegated Authority (CODA)

The authority delegated to the CFC Commander during peacetime for exercise over units of the Korean forces placed under wartime OPCON. It encompasses six areas: combined crisis management, operational plans establishment, combined exercises, combined joint doctrines development, ROK-U.S. combined intelligence management, and C4I interoperability.

Alliance Military Structure in the post-OPCON Transition Era' (Roadmap). The agreement included a plan to disestablish the ROK-U.S. Combined Forces Command and complete the wartime OPCON Transition to the ROK forces after October 15, 2009, but no later than March 15, 2012.

In January 2007, the permanent ROK-U.S. Military Committee (MC) signed the 'TOR on the Operation of the ROK-U.S. Combined Implementation Working Group,'<sup>7</sup> which was finalized in a February 2007 agreement during the Defense Ministerial Meetings, to complete wartime OPCON Transition on April 17, 2012. In accordance with this agreement, the Combined Implementation Working Group (CIWG) was formed to establish a Strategic Transition Plan (STP) to transfer wartime OPCON from the ROK-U.S. Combined Forces Command to the Joint Chiefs of Staff; in June 2007, the plan was signed by the ROK Chairman of the Joint Chiefs of Staff and the Senior U.S. Military Officer Assigned to Korea (SUSMOAK).

The ROK and the U.S. formed a joint verification group comprised of experts, and during the UFG exercise in 2009, the group verified the status of the preparations being made for wartime OPCON Transition and the initial operational capabilities (IOC)<sup>8</sup> of the ROK Joint Chiefs of Staff. The

**7. TOR on the Operation of the ROK-U.S. Combined Implementation Working Group (CIWG)**

TOR signed on January 19, 2007, between the ROK and the U.S. regarding the basic elements (purpose, principle, key players, milestone, etc.) required for the study and report of command relationships, such as the wartime OPCON Transition.



Agreement on the Strategic Transition Plan (STP) for the implementation of the wartime OPCON Transition (Seoul, June 2007)

**8. Initial Operational Capability (IOC) verification**

This refers to the confirmation and evaluation of definitive operational concepts and the extent of achievement of the required operational capabilities regarding newly acquired weapons systems to be deployed in the field, and the extent of readiness of developed fielded support elements.



Scene after tank combat training during the UFG Exercises in 2010 (August 2010)

findings were reported as 'Normal implementation' at the ROK-U.S. Security Consultative Meeting (SCM) and the ROK-U.S. Military Committee Meeting.

The Strategic Transition Plan that the ROK and the U.S. had initially agreed upon was replaced by the Change Two of the Strategic Transition Plan (March 2010), which was prepared based on the supplementary requirements brought to light when the new combined defense system was applied during the UFG exercise.

On June 26, 2010, the Presidents of the ROK and the U.S. agreed to the stable management of security on the Korean Peninsula, assurance of an internally stable wartime OPCON Transition, and the deferral of the wartime OPCON Transition from April 17, 2012, to the end of 2015, in order to alleviate national concerns regarding security issues. This agreement was followed by the ROK-U.S. Foreign and Defense Ministers' Meeting (2 + 2) of the ROK and the U.S. to discuss stable wartime OPCON Transition.



ROK-U.S. Summit Talks (Toronto, Canada, June 2010)

### 3. Backdrop and Significance of the Adjustment of the Date for the Wartime OPCON Transition

Throughout the years the ROK and the U.S. have kept a close watch on the military threat posed by North Korea and have jointly verified and evaluated the progress of the wartime OPCON Transition. In the process, they became aware of the need to adjust the timing of the transition in light of the increased threat of North Korea and other changes in the security environment. Consequently, the ROK Government requested that the U.S. Government adjust the timing of wartime OPCON Transition. The backdrop to this is as follows:

First, there has been an increased uncertainty around the security and instability on the Korean Peninsula, including the rise of the North Korean threat. North Korea has continued with its development of nuclear and ballistic missiles and has increased the risk of threat of military provocation through incidents such as the ROKS Cheonan attack, and consequently, the South-North Korea relationship continues to be one of conflict and tension. The instability of the North Korean regime is also worsening: the failure of currency reform, the worsening health of Kim Jong Il (the Chairman of the

National Defense Commission), and the attempt to pass power to his son (3rd generation power succession).

Second, the fact that 2012 will be a period of high mobility in terms of politics and security, with a change of leaders in several countries in the region, was taken into consideration. The year 2012 sees the occurrence of several politically sensitive events: general elections (April) and presidential elections (December) in the ROK, presidential elections in the U.S. (November), the fact that it is North Korea's target year for achieving its goal of becoming a "strong and prosperous nation," transfer of leadership within China's Communist Party (October), and presidential elections in Russia (March).

Third, over half of the Korean population wished for the deferral of the wartime OPCON Transition due to the unstable security environment. Over ten million people participated in the campaign to collect signatures, held in May 2010, in opposition of the dissolution of the ROK-U.S. Combined Forces Command. Based on opinion polls,<sup>9</sup> over 50% of the people were against the wartime OPCON Transition or were of the opinion that it should be delayed.

Against this backdrop, the Governments of the ROK and the U.S., while respecting the decisions of the previous administrations, agreed to readjust the timing of the transition in light of the security environment and the general strategic conditions being demonstrated.

#### **4. Major Content of the Wartime OPCON Transition**

Wartime OPCON Transition signifies the transition from a command system centered on the ROK-U.S. Combined Forces Command to a new combined defense system 'led by the Joint Chiefs of Staff (JCS) and supported by the US KORCOM.' The ROK and the U.S. have built a joint implementation system in order to achieve such a new combined defense system. The ROK and U.S. also selected detailed tasks in six areas and are systematically preparing for the wartime OPCON Transition: commissioning a theater operation command system, inaugurating the ROK-U.S. military coordination system, establishing a new Operational Plan, constructing a theater operation execution system, establishing a combined exercise system, and building the foundation and basis for the

#### **9. Opinion Polls**

·The Munwha Ilbo (November 2, 2009)

·The Donga Ilbo (May 22, 2010)

wartime OPCON Transition.

The first task is to establish two independent and mutually complementary Theater-level Combatant Commands to enable command of theater operations 'led by the JCS and supported by the US KORCOM.' For this purpose, in April 2009, the JCS reshuffled its organization in order to be able to carry out the functions of a Theater-level Command. The USFK Command Headquarters is also preparing for its transition to the US KORCOM. The JCS Theater Command Facility is being built and is scheduled to be completed in 2012, and the US KORCOM theater command facility is expected to be completed in 2015, in step with the Yongsan Relocation Plan (YRP).

The second task involves ensuring the supported-supporting command relationship between the ROK and the U.S. and constructing a strong military coordination system for all units and over all functions for the efficient integration of operations. To this end, the ROK and the U.S. will form various military coordination bodies and liaison bodies at the strategic, operational and tactical levels, and the use of these bodies will be expanded even during peacetime.

The third task involves the development of operational plans through a joint planning system for operational planning during armistice and war and establishing a new operational plan to be applied after the wartime OPCON Transition. To this end, since 2008, the ROK and the U.S. have been establishing a new operational plan by setting up a joint planning system.

The fourth task involves the construction of a system that allows the JCS to lead theater operations. To this end, SOPs and directives for executing theater operations, crisis management systems, and an intelligence cooperative structure are being developed, and the ROK and the U.S. are also developing the Alliance Korean Joint Command Control System (AKJCCS) for their joint use.

The fifth task involves preparing a foundation for training exercises to ensure that the Korean forces are equipped with the ability to lead combined exercises. To this end, the ROK and the U.S. have been establishing exercise structures for pre- and post-OPCON Transition and developing their exercise planning and control capabilities, constructing new opposition force simulation facilities, operating after action review teams, and wargame models.

The sixth task involves providing the personnel, material and legal bases and the foundation needed to construct the new combined defense system. Specifically, personnel management within the JCS and ROK-U.S. Combined Forces Command (CFC) will be improved in order to recruit human resources and replace the standards applied under the CFC, such as the Terms of Reference (TOR)/Strategic Directive No. 2 with the TOR/Strategic Directive No. 3 to be applied under the new combined defense system. The ROK and the U.S. intend to establish a joint verification structure to verify whether the preparations for the wartime OPCON Transition and the furnishing of mission execution capabilities are meeting their targets.

## 5. The Way Ahead

At the 42<sup>nd</sup> U.S.-ROK Security Consultative Meeting (SCM)<sup>10</sup> in October 2010, the ROK and the U.S. agreed to the 'Strategic Alliance 2015,' which covers the main alliance issues related to the wartime OPCON Transition. The Strategic Alliance 2015 is a comprehensive implementation plan aimed at creating stable conditions for the wartime OPCON Transition by successfully pushing ahead with the wartime OPCON Transition and all the related issues. A joint working group participated in by related bodies, including the defense and foreign affairs officials of the ROK and the U.S., will evaluate and verify the status of the alliance's implementation through the ROK-US Security Policy Initiatives (SPI),<sup>11</sup> ROK-US Military Committee Meetings (MCM), and ROK-U.S. Security Consultative Meetings (SCM).

### 10. ROK-U.S. Security Consultative Meeting (SCM)

An annual consultative body held since 1968 in the areas of defense and security between the ROK and the U.S. defense ministers.

### 11. ROK-U.S. Security Policy Initiatives (SPI)

A consultative group among the national defense and foreign affairs authorities of the ROK and the U.S. The top representatives of this body are the Deputy Minister for National Defense Policy of the MND and the Deputy Assistant Secretary for East Asia of the U.S. Department of Defense.

# Ensuring Secure Stationing Conditions for the United States Forces in Korea (USFK)

The ROK Government is making every effort to provide a stable stationing environment for the United States Forces in Korea (USFK) and to promote mutual trust in order to solidify and maintain the ROK-U.S. Alliance. The two nations consult closely to ensure seamless implementation of the USFK realignment and the appropriate level of defense cost-sharing. Also, they engage in various activities to reinforce policy consultations and promote trust.

## 1. USFK Realignment and Tour Normalization

The ROK and the U.S. Governments are consolidating, closing and relocating the U.S. military bases scattered nationwide in order to ensure the balanced development of the territory and a stable stationing environment for the U.S. forces in Korea. The USFK base relocation project is divided into two plans: the 'Land Partnership Plan' (LPP),<sup>1</sup> which seeks to relocate the U.S. bases nationwide, and the 'Yongsan Relocation Plan' (YRP) for the relocation of U.S. bases nationwide. The relocation of Yongsan Garrison has been discussed since March 1988 and was agreed upon during the ROK-U.S. Summit in May 2003. In 2004, the relocation gained momentum with the conclusion of the Yongsan Relocation Plan Agreement. The LPP began with the signing of the LPP Agreement in 2002. In 2004, the LPP Agreement was amended to include the U.S. 2<sup>nd</sup> Infantry Division relocation plan, and this version is in force today.

Thereafter, in March 2007, the ROK and U.S. agreed on the Facility Master Plan that provided for the relocation of the major USFK bases to Pyeongtaek City, and in November of the same year, the two nations held a groundbreaking ceremony in Pyeongtaek. Currently, land development and the construction of

### 1. Land Partnership Plan (LPP)

This plan spells out the details for consolidating and closing USFK facilities nationwide and for the return of unnecessary facilities and land. A letter of intent was signed during the 33<sup>rd</sup> SCM held in November 2001. The LPP Agreement and its amendment were ratified by the National Assembly in January 2002 and December 2004, respectively.

infrastructure, such as roads, electricity, gas and waterworks, are in progress. In accordance with the Special Act on the Assistance to Pyeongtaek City, for the Relocation of USFK Bases, the ROK is simultaneously pushing ahead with the construction of residential support facilities for the affected residents in the relocation area, such as building roads, constructing waterworks and sewerage facilities, and constructing town halls.

Meanwhile, in the process of USFK realignment, a total of 47 U.S. bases, with an area of approximately 138 million m<sup>2</sup>, have been returned to Korea and an additional 33 U.S. bases, with an area of approximately 40 million m<sup>2</sup>, are scheduled to be returned. In March 2009, the two nations agreed to apply the 'Joint Environmental Assessment Procedure,' an improved version of the existing environmental investigation procedure, in order to resolve environmental pollution issues in the USFK bases that are to be returned. Based on this, the two nations are in close coordination for environmental remediation within the U.S. bases that are scheduled to be returned.

Tour normalization of USFK service members is currently in progress, scheduled to be completed by the year 2020. The system will be changed such that a service member can extend his/her service in Korea for up to three years, while staying together with his/her family, as opposed to one to two years of service apart from his/her family. Such measures by the U.S. Government will improve the working conditions and, therefore, the stable stationing conditions for the USFK; this, in turn, will enhance the strength of the ROK-U.S. combined defense posture and is also expected to contribute to an increase in exchanges between the citizens of the two countries and to the steady growth of the ROK-U.S. Alliance.

## 2. Defense cost-sharing

This refers to the Korean Government's fiscal subsidies in relation to USFK stationing expenditures based on the Special Measures Agreement (SMA).

### 3. Items of support under defense cost-sharing (as of 2010)

Item	Content
Labor Costs	Labor costs for Korean employees hired by the USFK
Military Construction	Construction of facilities for the USFK
Logistical Support	Service and material support for the USFK, including storage of ammunitions, aircraft repair and maintenance

## 2. Defense Cost-Sharing

Since the signing of the Special Measures Agreement (SMA) in 1991, the ROK Government has shouldered a portion of the USFK stationing costs. The amount of such a portion is decided in overall consideration of such factors as the ROK Government's financial capacity and a stable stationing environment for the USFK.

One such defense cost-sharing<sup>2</sup> item is the Combined Defense Improvement Project, a supported item<sup>3</sup> until 2008. As its needs have been almost completely satisfied, it has, therefore, been integrated into the military construction item starting in 2009.

The Ministry of National Defense (MND) was in charge of negotiations for



defense cost-sharing up to 2004, but since this time, the Ministry of Foreign Affairs and Trade (MOFAT) has taken the lead, with the participation of the MND. Defense cost-sharing had been paid partly in U.S. Dollars and in Korean Won, but since 2005, payments have been made entirely in Korean Won. Thus, it has become possible to manage a stable budget, independent from changes in foreign exchange rate.

In December 2008, the ROK and U.S. agreed to a new settlement of defense cost-sharing arrangement for 2009 through 2013. Thereafter, the arrangement came into effect upon ratification by the National Assembly in March 2009.

This new arrangement, which is effective for the five years from 2009 to 2013, states that defense cost-sharing would be increased reflecting the consumer price index two years prior but, in any event, would not exceed four percent. Accordingly, Korea paid 760 billion Korean Won (applying the 2.5% inflation rate of 2007) and 790.4 billion Korean Won in 2010 (the inflation rate in 2008 was 4.7% but the ceiling of 4% was applied).

An appropriate level of defense cost-sharing by the ROK Government achieves the following: it fosters a stable stationing environment for USFK service members and it solidifies the ROK-U.S. combined defense posture and thereby contributes to the security of and peace on the Korean Peninsula. In addition, the monetary support for USFK stationing helps the local economy and boosts domestic demand because it generates the USFK's demand for equipment, services and construction, which in turn creates jobs.

### 3. Enhancing Mutual Trust

**| Stimulating policy consultations** | The two countries operate various policy consultative bodies to closely discuss alliance issues and the direction of security policies. The SCM, which has been held since 1968, and the ROK-U.S. Security Policy Initiative (SPI), held since 2005, have contributed greatly to the enhancement of mutual trust and to resolving major alliance issues.

At the 41<sup>st</sup> SCM held in Seoul in October 2009, the two nations reconfirmed the U.S. commitment to the defense of the Korean Peninsula and agreed to maintain a solid combined defense posture and policy cooperation against the threat of North Korea. The two nations evaluated the progress of the wartime OPCON Transition, and checked for supplementary requirements, and also agreed to strengthen their defense cooperation in order to construct a

comprehensive strategic alliance.

As of November 2010, the ROK and the U.S., through three SPI sessions, agreed to strengthen cooperation against military provocation by the North; they inspected the progress of the relocation of USFK bases and the OPCON Transition and consulted one another regarding coordination of the two nations over regional and global security issues facing them, such as the Provincial Reconstruction Team (PRT) in Afghanistan.



The 41<sup>st</sup> ROK-U.S. Security Consultative Meeting (SCM) joint press conference (Seoul, October 2009)

The 42<sup>nd</sup> U.S.-ROK SCM was held in Washington, D.C. in October 2010. At this meeting, which was held at a sensitive period in terms of security, in light of NK's attack on the ROKS Cheonan and the full-blown start of the passing of power in North Korea, the two nations agreed to and signed three strategic documents that have important significance in the future development of the alliance. First, by agreeing to and signing the 'Guidelines for ROK-U.S. Defense Cooperation Directive,' the blueprint for defense cooperation between the two nations was set pursuant to The Joint Vision for the Alliance of the ROK and the USA. Second, the two nations completed the Strategic Alliance 2015, which is the new wartime OPCON Transition plan for implementing the agreement on the readjustment of the timing of the wartime OPCON Transition. Third, the two parties advanced the Strategic Planning Guidance (SPG), which provides the strategic guidelines and authority required to advance operational planning to the ROK-U.S. Military Committee, and also agreed to regularly hold a ROK-U.S. consultative body called the 'Extended Deterrence Policy Committee' to discuss nuclear issues and conceive effective means of preparing against the North



The 42<sup>nd</sup> U.S.-ROK Security Consultative Meeting (SCM) (Washington, D.C., October 2010)

Korean nuclear threat. In addition, the two parties discussed means of working together against North Korea in the aftermath of the ROKS Cheonan incident and how to strengthen cooperation on regional and global issues, such as the reconstruction aid in Afghanistan.

The two nations have also been discussing various security issues through ROK-U.S. Security Consultative Meeting (SCM) sub-committees: the Military Committee (MC), the Security Cooperation Committee, Logistics Cooperation Committee (LCC), and the Defense Technology and Industrial Cooperation Committee (DTICC)

**| Strengthening friendship activities |** Every spring and fall, through eight events, the MND exposes USFK service members to the Korean culture by showing them the old palaces in Seoul, the Korean Folk Village, and the War Memorial of Korea. Through the 'Friends Forever Program,' around 600 U.S. service members experience the Korea's cultural heritage, traditional folk games, dance and traditional music every year.

The ROK-U.S. Combined Forces Command encourages cultural exchanges between the two nations and friendship activities within local communities through the 'Good Neighbor Program.' The exchange programs directly led by the USFK under this Program include: the Executive Orientation Program, which introduces the role, issues and tasks carried out by the ROK-U.S. Combined Forces Command to leaders of the community, such as the Korean Government, the press, businesses, and academia; Good Neighbor English Camps for Korean students; the Good Neighbor Award Ceremony; operation of an advisory council for the CFC Commander; and meetings between high school students and war veterans.

The exchange programs led by the Korean military include: a program introducing Korean culture to USFK members; visits to battle sites, military units, war tactics discussions, and cultural tour programs for generals; a ROK-U.S. Combined Forces Command establishment commemoration event; and support for various social welfare facilities and the provision of aid to residents.

Since 1970, the United Service Organization Korea (USO Korea) has, annually honored around 80 model service members of the U.S. military, ROK forces, and UN forces through the 'six-star salute ceremony.'

Such activities to strengthen ties have contributed to a greater understanding of each country's culture and to creating closer friendly relations.

## Section 4

# Expanding the Boundaries of Defense Diplomacy and Cooperation

The Ministry of National Defense (MND) is enhancing its cooperative military relationships with Japan, China and Russia by building upon the foundation provided by the ROK-U.S. Alliance, thereby creating a favorable strategic environment for security on the Korean Peninsula. The MND is expanding the boundaries of defense diplomacy from Northeast Asia to the global arena, including Southeast Asia, the Middle East, Africa, and Latin America. Through the expansion of defense exchanges and cooperation, it is contributing to the advancement into government-run projects and increasing exports by the defense industry. It is actively participating in multilateral security consultative bodies and international cooperative organizations, and through such efforts, it will perform in a manner befitting Korea's status in the global community.

## 1. Defense Exchanges and Cooperation with Neighboring Countries

**Exchange and cooperation with Japan** | As allies of the United States, the Republic of Korea and Japan<sup>1</sup> share the same basic values of liberal democracy and a market economy. Based on this, they have continued to raise the level of cooperation in various areas. In the security area, the two countries cooperate through bilateral and multilateral talks to resolve the North Korean nuclear issue and to ensure regional security and peace.

The defense authorities of the two nations have held periodic Defense Ministers' Meetings since 1994. At the 14<sup>th</sup> Defense Ministers' Meeting held in April 2009 in Japan, the two nations signed the 'Letter of Intent on Defense Exchanges between the Republic of Korea and Japan,' which comprehensively outlined the operation of a periodic consultative body, personnel exchanges, educational exchanges, and joint training.

At the Vice Ministers' Meeting held in June 2009 in Seoul, the two nations discussed ways of implementing defense exchanges and cooperation, including the expansion of joint exercises for humanitarian purposes. At

### 1. Development of ROK-Japan relations

- 21st century Korea-Japan Joint Partnership (1998)
- Future-oriented Korea-Japan relations (2005)
- Future-oriented mature partnership (2008)

the Asia Security Summit<sup>2</sup> held in June 2010 in Singapore, the National Defense Ministers from the two nations exchanged their views regarding major security and cooperative issues. The two nations also hold working-level talks, such as the Defense Policy Talks, Security Policy Dialogue (foreign affairs and defense officials), and Working-level Meetings on Defense Exchanges and Cooperation, to enhance mutual understanding and expand the scope of cooperation.

Meetings among senior level officers, such as the Chairman of the Joint Chiefs of Staff and the chiefs of each Service, also take place frequently. Also, personal exchanges take place regularly, including working-level meetings for each of the Army, Navy, and Air Force, exchanges among units, exchange visits of cadets, and exchange of military students for overseas studies. Recently, the two nations have been expanding exchanges and cooperation to, among others, Korea-Japan maritime search and rescue exercises, reciprocal visits between transport aircraft, and mutual cooperation in international peacekeeping activities.

However, the different historical perspective held by Japan, and its unjust claim to territorial sovereignty over Dokdo, which is ROK sovereign territory, remain factors that must be overcome to ensure the development of future-oriented defense exchanges and cooperation between the two countries. In the future, the MND will solidify the existing military trust and ties with Japan and will strive to further develop the relationship as a 'future-oriented and mature partnership' as provided at the ROK-Japan Summit in April 2008.

**| Exchange and cooperation with China |** Since their diplomatic relations were established in 1992, the ROK and China<sup>3</sup> have been making rapid progress in diverse sectors, such as the political, economic, social and cultural areas. In May 2008, the relationship between the two nations was elevated to a 'strategic cooperative partnership,' leading to active exchanges and cooperation in the defense area, as well.

In March 2009, the General Chief of Staff of China's People's Liberation Army visited Korea to discuss with the ROK JCS ways of strengthening the exchanges and cooperation between the two countries. In May 2009, Korean Minister of National Defense visited China the day after North Korea's second nuclear test and agreed with his Chinese Counterpart to

## 2. Asia Security Summit

The Asia Security Summit is the highest-level forum for defense dialogue in which Defense Ministers as well as security experts from 27 countries in the Asia-Pacific region and Europe participate. It is held at the Shangri-la Hotel in Singapore every year and is otherwise known as the Shangri-la Dialogue.



ROK-Japan joint maritime search and rescue exercise (on the waters near Oki Islands, Japan, July 2009)

## 3. Development of ROK-China relations

- Friendly cooperative relationship (1992)
- Cooperative partnership (1998)
- Comprehensive cooperative relationship (2000)
- Comprehensive Cooperative Partnership (2003)
- Strategic Cooperative Partnership (2008)

#### 4. ASEAN Defense Ministers' Meeting Plus (ADMM-Plus)

A new security consultative body launched in 2010 that expanded the previous ASEAN Defense Ministers' Meeting, held since 2006, and which included 10 countries, to include eight major countries in the Asia-Pacific region (ROK, U.S., Japan, China, Russia, India, Australia and New Zealand).



Friendly Visit of the PLA Navy ship Zheng He (Jinhae, October 2009)

#### 5. Development of ROK-Russia relations

- Constructive and mutually complementary partnership (1994).
- Comprehensive partnership of mutual trust (2004).
- Strategic cooperative partnership (2008).

cooperate closely toward resolution of the North Korean nuclear issue. In April and November 2009, respectively, the Chief of Naval Operations and the Air Force Chief of Staff each participated in the international celebration for the 60<sup>th</sup> anniversary of the PLA Navy and Air Force.

In October 2010, at the ASEAN Defense Ministers Meeting Plus (ADMM-Plus)<sup>4</sup> held in Vietnam, the defense ministers from the ROK and China both expressed their sympathy regarding the need for close cooperation between the nations for stability and peace on the Korean Peninsula.

At the working level, exchanges are taking place through not only the Defense Policy Talks but also through exchanges between regional command headquarters, such as the 3<sup>rd</sup> ROK Field Army and the PLA Jinan Military District, the 2<sup>nd</sup> Fleet Command and the PLA North Sea Fleet Command, and the 3<sup>rd</sup> Fleet Command and the PLA East Sea Fleet Command. In addition, in April 2009, a Korean naval vessel visited China in celebration of the 90<sup>th</sup> anniversary of the establishment of the Provisional Korean Government in Shanghai. In October of the same year, the PLA Navy ship Zheng He visited Jinhae. In addition, exchanges between military athletic units, military research institutions and educational institutions have been active.

In the future the defense ministries of the two nations will continue to expand their exchanges and cooperative programs as befitting of a 'strategic cooperative partnership' and will contribute to peace and stability on the Korean Peninsula and in Northeast Asia.

#### | Exchange and cooperation with the Russian Federation |

Relations between the ROK and Russia,<sup>5</sup> for which 2010 signals the 20<sup>th</sup> anniversary of the establishment of diplomatic relations, are steadily developing in various areas. In September 2008, the relationship between the two nations was elevated to a 'strategic cooperative partnership,' and in step with this, the level of cooperation in various sectors including politics, economy, energy and space technology are being reinforced.

In 2009, the ROK Minister of National Defense and the President of the Army College visited Russia, and in turn, the Russian Commander of the Air Force, the Commander of the Pacific Fleet, and the Chief of the Russian General Intelligence Directorate visited Korea. Meetings between the ROK

and Russian Air Forces, academic seminars between the ROK Institute for Military History Compilation and the Russian Institute of Military History were held in Seoul and Moscow, respectively.

In 2010, a number of events were held in both countries in celebration of the 20<sup>th</sup> anniversary of diplomatic relations between the ROK and Russia. In November, the defense conferences sponsored by the Korea Institute for Defense Analyses were held in Seoul, where evaluations and forecasts were made regarding military cooperation between the ROK and Russia, and in the future, the two nations will continue to expand their exchanges and cooperative programs in the defense area.

## 2. Defense Cooperation with Countries outside the Region

**| Southeast Asia and Oceania |** Through the Association of Southeast Asian Nations (ASEAN), the Southeast Asian region maintains dynamic regional cooperation in the political, economic, and security sectors. This region is gradually becoming more important in terms of issues such as international financial crises, climate change, food, energy, and security, and also accounts for the third largest volume of trade with Korea, followed by China and the EU. In particular, with more than 30 percent of Korea's trade volume and 90 percent of the petroleum imported into Korea passing through the Strait of Malacca, cooperation with the relevant countries is vital to securing stable sea lanes of communication.

The ROK Government is seeking to enhance friendly relations with Asian countries and the common prosperity of Asia-Pacific countries under the policy tenet of 'New Asia Diplomacy.'<sup>6</sup> In particular, in March 2009, the ROK president toured Indonesia, Australia and New Zealand, and in June, he also attended the Korea-ASEAN Special Summit before touring Vietnam and Cambodia in October, thereby forming close relations with Asian countries.

At the ROK-Vietnam Summit in October 2009, the relations between the two nations was elevated to 'strategic cooperative partnership,'<sup>7</sup> and the two nations agreed to open strategic dialogues regarding foreign affairs and security. The two nations' assessment of their past defense industrial cooperation and military exchanges was positive, and it was agreed that military exchanges would be expanded in the future. At the ROK-ASEAN

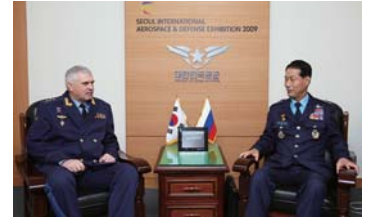

Courtesy Visit from the Commander of the Russian Air Force to the Air Force Chief of Staff (Seongnam, October 2009)



Strait of Malacca

### 6. The New Asia Diplomacy

This refers to the principle in which the Asian nations develop a comprehensive cooperative relationship that spans all sectors, such as the political, economic, security and social areas, and thereby take a leading role in resolving global issues including the global financial crisis and climate change.

### 7. Development of ROK-Vietnam Relations

- 21<sup>st</sup> century comprehensive partnership (2001).
- Strategic cooperative partnership (2009)

#### 8. MOU on Korea-Singapore Defense Cooperation

This memorandum of understanding (MOU) enhances comprehensive cooperation in the defense area, including reciprocal visits by senior level military officers, training and educational exchanges, military medicine, military sports, etc.

#### 9. MOU on Korea-Philippines Mutual Logistics Cooperation

This memorandum of understanding (MOU) lays out the entities eligible for reciprocal logistical support, and the procedure thereof, in the event of combined operations by the two nations' military, PKOs, or disaster relief activities or contingency situations

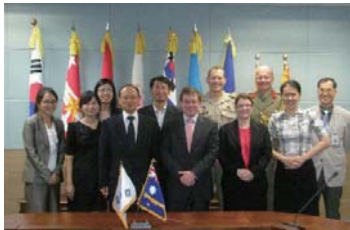

Korea-Australia Defense Policy Talks (Seoul, August 2010)

#### 10. ROK-Australia Joint Statement on Global and Security Cooperation

In this joint statement, the two nations agreed to reinforce cooperation regarding major security issues, such as joint actions to be taken against transnational and non-military threats, global financial crises, international peacekeeping operations, etc.

Summit in October 2010, the relations between the two nations were elevated to that of a 'strategic partnership,' thereby building the foundation for the future-oriented development of the relationship.

In October 2009, the Defense Minister of Malaysia visited Korea and, agreed to promote increased defense exchange and cooperation between the two countries. In December, the ROK Minister of National Defense visited Singapore and the Philippines and signed an MOU on Korea-Singapore Defense Cooperation<sup>8</sup> and an MOU on Korea-Philippines Mutual Logistics Cooperation.<sup>9</sup> Also, the Minister visited Indonesia in August 2010 and Vietnam in October to exchange views on regional security conditions and discuss measures to enhance exchanges and cooperation and defense industrial cooperation.

Defense diplomacy with the Oceania nations is centered on Australia and New Zealand. The MND holds Defense Policy Talks every year to discuss mutual security interests and measures to broaden defense cooperation with the ministries of defense of Australia and New Zealand, and is also strengthening bilateral and multilateral cooperation regarding international security issues, such as counter-terrorism and anti-proliferation activities.

In March 2009, President Lee Myung-bak visited Australia and adopted the 'Joint Statement on Enhanced Global and Security Cooperation between Australia and the Republic of Korea,'<sup>10</sup> whereby the two nations agreed to reinforce cooperation with respect to overcoming economic crises and responding to transnational and non-military threats. In May 2009, the ROK and Australia signed the 'General Security of Military Information Agreement (GSOMIA)' and the two countries will continue to enhance cooperation in areas such as international peacekeeping operations, military educational and training exchanges, and the defense industry.

**| Southwest Asia |** The ROK Government is enhancing its defense exchanges and cooperation with Southwest Asian nations such as India and Pakistan through the exchange of visiting graduate students at the National Defense University, dispatching military officers for entrusted education, arranging visits by the cruise training fleet, etc.

Due to its rapid economic growth, India has recently emerged as a regional leader. In 2010, the ROK Government and the Government of India entered into the Comprehensive Economic Partnership Agreement



(CEPA). In September 2010, the MND held the ROK-India Defense Ministers' Meeting, where the two nations entered into an MOU regarding defense cooperation and an MOU on defense research and development cooperation, thereby providing the foundation for building strategic defense cooperative relations.

In April 2009, the ROK Government participated in the Friends of Democratic Pakistan (FODP) Meeting and made clear its support of Pakistan's important role in the implementation of anti-terrorist actions and promised humanitarian aid of 200 million US dollars. In the future, it plans to gradually expand personal exchanges, such as educational exchange programs for student officers.

**| The Middle East |** The Middle East is the region from which Korea imports petroleum and where Korean companies take on large-scale government projects. In particular, in December 2009, the Korea Electric Power Corporation (KEPCO) won the bid for building a nuclear power plant in the UAE.

The MND is actively promoting exchanges between senior-level military officers and those of Middle Eastern countries in order to strengthen friendship and defense industrial cooperation. In January 2009, the Iraqi Minister of Defense visited Korea for the first time, and the two nations discussed the enhancement of their defense industrial cooperation through the Defense Ministers' Meeting, thereby paving the way for Korea's defense industry to commence exporting to Iraq. In October 2009, senior level officers from Jordan visited Korea for the '2009 Seoul International Aerospace & Defense Exhibition' (SEOUL ADEX 2009), at which time the two nations entered into the Defense Cooperation Agreement. In November 2009, the ROK Minister of National Defense visited the UAE to discuss measures for promoting defense cooperation; in February 2010, the General Chief of Staff of the UAE visited Seoul, and the two nations agreed to defense exchanges and cooperation, to enhancing defense industrial cooperation and to holding regular senior-level military talks. In the future, the ROK plans to expand defense cooperation with not only Saudi Arabia, as the core, but also Libya, Qatar and other Middle Eastern countries.



Signing of the ROK-India Comprehensive Economic Partnership Agreement (Seoul, September 2010)



Courtesy Visit of the UAE General Chief of Staff to the ROK Defense Minister (Seoul, February 2010)

| **Europe** | The MND is deepening its defense exchanges and cooperation with major European countries with whom the ROK has traditionally maintained friendly relations, thereby firmly establishing the foundation for peace and stability on the Korean Peninsula and Northeast Asia.

The Turkish Defense Minister visited the ROK in order to enter into an agreement on electronic warfare training equipment in April 2009, and during this visit, the two nations reconfirmed their traditionally robust alliance and discussed measures to promote cooperation in the defense industry.

In March 2009, the British Vice Chief of Staff of Defense visited Seoul, in July the 7<sup>th</sup> Defense Policy Talks were held, and in October the Vice Minister of Procurement visited Seoul. In January 2010, the ROK Vice Minister of Defense visited the United Kingdom and France, where he exchanged views with his counterparts regarding the defense acquisition system, defense industry policies, and overseas export subsidies.

The Defense Policy Talks that had been held at the director-general level between the ROK and France, over the course of nine meetings, were elevated to strategic talks at the deputy minister level in 2007 and defense issues were discussed. During the 3rd ROK-France strategic talks in December 2009, the two nations exchanged views regarding the dispatch of the ROK's protective units to the Provincial Reconstruction Team (PRT) in Afghanistan.

The ROK is expanding the boundaries of its defense diplomacy to Eastern European countries by engaging in comprehensive defense cooperation. In September 2009, the ROK and Poland entered into the General Security of Military Information Agreement (GSOMIA), and at the end of 2010, the two nations intend to enter into the Defense Cooperation Agreement. In February 2010, the ROK and Lithuania held Defense Ministers' Meetings for the first time and signed an MOU on defense cooperation. In the future the MND will continue to expand comprehensive exchanges and cooperation with countries in the Commonwealth of Independent States (CIS)<sup>11</sup> and other Eastern European countries.

| **Other Regions** | In December 2009, the ROK Government held the 3<sup>rd</sup> Korea-Central Asia Cooperation Forum<sup>12</sup> in Seoul; in February 2010, the



ROK-Turkey Defense Ministers' Meeting  
(Seoul, April 2009)



Lithuanian Defense Minister's visit to  
Korea (MND Welcoming Reception,  
February 2010)

#### 11. Commonwealth of Independent States (CIS)

The CIS is a union of independent nations that until 1991 were part of the former USSR.

#### 12. Korea-Central Asia Cooperation Forum

A consultative body to support the economic development of Central Asian countries by sharing Korea's experience in economic development, and to discuss ways of reinforcing cooperation in various sectors including information and communications, construction, pop culture, education and tourism.

Uzbek President visited Korea; and in April the Kazakh President visited the ROK. Through these events, the ROK and the countries of Central Asia are expanding their cooperative relations beyond the energy and resource sectors to include various sectors, such as the military, construction, culture and tourism sectors. In December 2009, the 1<sup>st</sup> ROK-Uzbekistan defense policy talks were held in Seoul. In February 2010, the defense ministries of the two nations signed the 'Korea-Uzbekistan MOU on Defense Industrial Cooperation.' In September 2010, the Defense Minister of Kazakhstan visited Korea, for the first Defense Ministers' Meeting between the two countries, at which they consulted one another about the development of defense exchanges and cooperation.

In October 2010, the second defense policy talks were held with Uzbekistan and Ukraine, respectively.

The ROK donated eight A-37 aircraft to Peru and is in other ways gradually expanding its defense exchanges and cooperation with Latin American countries as well. In February 2010, it sent the Danbi Unit to Haiti, contributing to the expansion of exchanges and cooperation with Latin American countries.

Pursuant to the ROK Government's policy of expanding its cooperation with African nations, it is pursuing exchanges in the defense area with such nations as well. In September 2010, it sent an MND on-site investigation team to Gabon and Equatorial Guinea in West Africa to assess the possibility of exchanges and cooperation and to build a channel for cooperation regarding defense industry exports.

### 3. Multilateral Security Cooperation, International Disarmament and Non-proliferation Activities

**| Multilateral Security Cooperation |** Multilateral security cooperation is becoming increasingly more necessary in order to handle traditional threats as well as transnational and non-military security threats. The MND is expanding its cooperation with major multilateral security consultative bodies within the Asia-Pacific region and is participating actively in regional and international joint efforts to respond to various security threats. The major multilateral security consultative bodies in which the MND participates are shown in Table 4-1.

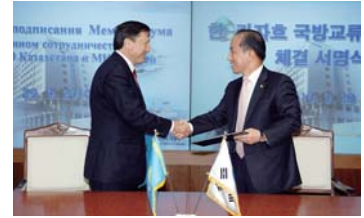

ROK-Kazakhstan MOU on Defense Cooperation (Seoul, September 2010)



Visit by MND On-Site Investigation Team (Equatorial Guinea, September 2010)

**Table 4-1. Multilateral Security Consultative Bodies in the Asia-Pacific in which the MND Participates**

Inter-governmental	Semi-governmental, non-governmental
<ul style="list-style-type: none"> <li>· Northeast Asia Peace and Security Mechanism Working Group (NEAPSM W/G) within the Six Party Talks framework</li> <li>· ASEAN Regional Forum (ARF)</li> <li>· Tokyo Defense Forum (TDF)</li> <li>· ASEAN Defense Ministers' Meeting Plus (ADMM-Plus)</li> </ul>	<ul style="list-style-type: none"> <li>· Northeast Asia Cooperation Dialogue (NEACD)<sup>13</sup></li> <li>· Asia Security Summit (The IISS Shangri-la Dialogue)</li> </ul>

**13. Northeast Asia Cooperation Dialogue (NEACD)**

Consultative body in which the members exchange views on Northeast Asian security issues and discuss means of building confidence.

The 3<sup>rd</sup> session of the Northeast Asia Peace and Security Mechanism Working Group (NEAPSM), one of the five working groups within the Six-Party Talks framework, was held in Moscow in February 2009; at this meeting, views were exchanged in order to draft the Basic Principles on Northeast Asian Peace and Security. The 21<sup>st</sup> Northeast Asia Cooperation Dialogue (NEACD) was held in Seoul in October 2010, during which Northeast Asian security trends were discussed, views were shared regarding military training in Northeast Asia, as well as the prevention and management of maritime accidents in Northeast Asia.

The ROK Government is increasing its level of participation in the ASEAN Regional Forum (ARF), which is becoming the major multilateral security consultative body in the Asia-Pacific Region. In line with this, the MND has been strengthening its role, jointly hosting the meeting of the ARF Inter-sessional Support Group on Confidence Building Measures and Preventive Diplomacy with the Singaporean Ministry of Defense in April 2009, in Seoul, and in March 2010, hosting the 'ARF PKO Experts Meeting' in Bangkok, jointly with the Thai Ministry of Foreign Affairs.

Every year the MND participates in the Tokyo Defense Forum (TDF), an Asia-Pacific region director-general-level security consultative body, in an effort to promote military confidence and cooperation among the countries in the region.

In June 2010, the 9<sup>th</sup> IISS Asia Security Summit, jointly sponsored by the Singaporean Government and the International Institute for Strategic Studies (IISS) of the UK, was held in Singapore. The Minister of National Defense introduced, in detail, Korea's efforts toward Asia-Pacific regional security cooperation through the presentation at the plenary session, titled

'Alliances and Partnership in Asia-Pacific Security.' In this speech, he also stressed the importance of constructing partnerships at the regional and international levels. Also, during bilateral talks (with 11 nations) and luncheon discussion sessions, the Minister of National Defense detailed the findings of the investigation into the attack on the ROKS Cheonan and the ROK Government's intended response, and requested support and cooperation from the participant nations.



Minister Kim's Presentation at Plenary Session, Asia Security Summit (Singapore, June 2010)

In October 2010, the ASEAN Defense Ministers' Meeting Plus (ADMM-Plus), in which defense ministers from 18 nations participated, was held for the first time in Vietnam. The Meeting was very significant in that it was the first such body comprised of defense ministers in the Asia Pacific region. It is expected to take root as a forum for regular discussions about common security interests within the region. The participant nations have first of all agreed to cooperate in five areas in the future, namely humanitarian assistance and disaster relief, maritime security, military medical support, counter-terrorism, and peacekeeping operations. ADMM-Plus should not only remain as a means of discussing joint responses to transnational and non-military security threats but should also develop into a mechanism for multilateral security cooperation within the region so that traditional security issues, such as the Cheonan incident, can be discussed.

Recently, the North Atlantic Treaty Organization (NATO) established the principle of 'expansion of cooperation between NATO and non-member states' and designated the ROK, Japan, Australia and New Zealand as non-member states to cooperate with (contact countries). The ROK Government also recognizes the importance of cooperation with NATO in light of steadily increasing transnational and non-military threats, such as energy security, proliferation of WMDs, terror and cyber attacks.

Moreover, the MND is first pursuing cooperation in areas that are less burdensome from a military and fiscal perspective and easier to implement, taking into account the uniqueness of the security situation. It is focusing on personal exchanges while gradually increasing the scope of its participation in various educational programs and relevant personnel within NATO. In December 2009, the ROK entered into the Korea-NATO Security of Military Information Agreement in relation to the dispatch of the Provincial Reconstruction Team (protective unit) to Afghanistan. With the ROK's participation in the International Security Assistance Force (ISAF), we expect that cooperative relations with NATO will strengthen even further in the future.

**| International arms reduction · Non-proliferation activities |** The international community is strengthening its control towards countering the proliferation of WMDs and delivery vehicles through the existing non-proliferation regimes, such as international organizations and regulations. It is also pursuing the establishment of new international norms, such as UN Security Council Resolution 1929 and others. The international community is also continuing its efforts against the proliferation of conventional weapons and has reinforced export control so that small arms and strategic items or commodities<sup>14</sup> related to defense are not used to threaten international peace and safety. The ROK Government has participated actively in the international community's arms reduction and non-proliferation regimes since joining the United Nations in 1991. The extent of its participation is shown in Table 4-2.

#### 14. Strategic Items or Commodities

This refers to not only WMDs, conventional weapons and transport systems, but to goods, software and technology in general that can be used in their development and manufacture.

Table 4-2. ROK's Participation in International Arms Reduction and Non-proliferation Activities

	Classification	Joining Date
Nuclear Disarmament/ Non-proliferation	International Atomic Energy Agency (IAEA)	Aug. 1957.
	Nuclear Non-proliferation Treaty(NPT)	Apr. 1975.
	Comprehensive Nuclear Test Ban Treaty (CTBT)	Sep. 1999.
Biological/ Chemical Weapons Disarmament/ Non-proliferation	Biological Weapon Convention (BWC)	Jun. 1987.
	Chemical Weapon Convention (CWC)	Apr. 1997.
Missile Non-proliferation	Missile Technology Control Regime (MTCR)	Mar. 2001
	Hague Code of Conduct against Ballistic Missile Proliferation (HCOC)	Nov. 2002.
Conventional Weapons	UN Register of Conventional Arms (UNRCA)	Mar. 1993.
	Convention on Certain Conventional Weapons (CCW)	May 2001.
Multilateral Export Control Regimes	Nuclear Suppliers Group (NSG)	Oct. 1995.
	Zangger Committee (ZC)	Oct. 1995.
	Wassenaar Arrangements (WA)	Jul. 1996.
	Australia Group (AG)	Oct. 1996.
UN and Other Activities.	UN General Assembly 1st Committee/ UN Disarmament Commission (UNDC)	Sep. 1991
	Conference on Disarmament (CD)	Jun. 1996.
	Weapons of Mass Destruction Proliferation Security Initiative (PSI)	May 2009.

With the declaration of its official participation in the PSI immediately following North Korea's second nuclear test in May 2009, the ROK Government has started to actively participate in international non-proliferation efforts.

In order to support the government's PSI activities, the MND participates in the Operational Experts Group (OEG) meeting, workshops, and maritime interdiction exercises. In October 2010, Korea sponsored maritime interdiction exercises in which Korean, U.S., Japanese and Australian naval vessels and aircraft participated and a PSI seminar with 14 nations in Busan and the nearby seas.

The MND has participated in the ROK Government's preparations for the NPT in 2010, thereby showing the international community the seriousness of the North Korean nuclear issue and reaffirming the principle of non-recognition regarding North Korean nuclear arms.

Also, every year since 2005, the MND, jointly with the Organization for Prohibition of Chemical Weapons (OPCW), has held OPCW International Assistance and Protection Courses designed to convey techniques to be used in the event of chemical accidents or terror to Asian member states.



Maritime interdiction exercises [Busan, October 2010]



NBC Anti-terrorist demonstration [Nuclear, Biological, Chemical Defense Command, May 2010]

The MND also takes part in international arms reduction discussions regarding conventional weapons. In order to implement the CCW Protocol V under the CCW, which the ROK joined in January 2008, the MND enacted a directive in July 2009, actively participating in international efforts to minimize civilian losses and damages caused by explosive remnants of past wars.

To prevent civilian damages and losses, the international community has completely forbidden the use of cluster bombs through the signing of the Convention on Cluster Munitions (CCM) in December 2008. However, it would be problematic for the ROK to enter into this convention until the military threat from North Korea has been completely eliminated, because the convention, focused only on the humanitarian perspective, states that all cluster bombs currently in possession also be completely disposed of, in addition to prohibiting their production, use, storage and transfer. Instead, the ROK actively participates in discussions to restrict cluster bombs under the Convention on Certain Conventional Weapons (CCW), in which the humanitarian perspective is balanced with military effectiveness.

#### **4. Constructing International Logistics Cooperation Systems**

The MND is strengthening its international logistics cooperation in order to ensure stable logistics support through efficient use of the logistics support capabilities of its allies and friendly nations.

**| Logistics cooperation with the U.S. |** The MND is strengthening its mutually reciprocal logistics cooperative ties with the U.S. in step with the changes in the security environment surrounding the Korean Peninsula. It took over the United States' 'War Reserve Stocks for Allies' (WRSA) in December 2008, and to ensure speedy redeployment of U.S. military reinforcements in contingencies. It is also preparing a Memorandum of Agreement on Wartime Host Nation Support in Korea (WHNS).

The ROK and the U.S. are jointly pursuing ammunition demilitarization<sup>15</sup> programs for disposal of ammunition subject to demilitarization in an eco-friendly manner. One relevant facility is the incinerator, which was completely constructed in December 2007 and is currently in operation; another is the melt-out system,<sup>16</sup> which was completely constructed in 2009.

##### **15. Demilitarization**

Demilitarization refers to measures that prevent equipment and supplies being used for their original military purpose, such as amputation, destruction, modification or defacement such that their original shape is altered or military markings are removed; disposal and removal of ammunitions is the most common example of demilitarization.

##### **16. Melt-out system**

A warhead is put into a smelting furnace after being separated from the propellant in mid- and large-size caliber bullets and, at 90 degrees centigrade, the melted gunpowder is collected.



To procure equipment and repair parts from the U.S. in a prompt manner, the MND and the U.S. DoD held a senior-level procurement promotion meeting for the first time, in March 2010. Until this time, meetings related to procurement between the ROK and the U.S. were limited to improving the procurement systems for particular items at the level of the Defense Acquisition Program Administration and each Service. At this meeting, however, the two nations settled on means of improving the procurement of Foreign Military Sales (FMS) as well as commercial purchase items, so as to span all procurement items. Furthermore, they discussed the necessity of introducing a speedy private enterprise procurement system. In particular, the two nations will continue efforts toward shortening the time required for the procurements originating from the United States.

**| International logistics cooperation** | The MND is expanding its mutual logistics cooperation with major countries in order to ensure the smooth execution of missions with assistance from friendly nations that offer aid to the ROK in contingencies and support the activities of dispatched ROK forces. Until now, Mutual Logistics Support Agreements have been signed with the United States (1998), Thailand (1991), New Zealand (2007), Turkey (2008), Philippines (2009), Israel / Australia / Canada (2010), and the MND is also in talks with Japan, the United Kingdom, Spain, Indonesia, Singapore and Saudi Arabia over entering into such agreements.

The MND also contributes to military cooperation and defense industry exports by transferring obsolete defense articles generated by the modernization of ROK weapons system to friendly nations. The MND has transferred naval vessels, amphibious armored vehicles, aircraft, trucks and similar out-of-date equipment to the Philippines, Bangladesh, Kazakhstan, Indonesia, Peru, Ghana and Cambodia and also plan to transfer obsolete ammunition that is no longer in use to Colombia .

# Section 5

## Contributions to International Peacekeeping Operations

Historically, the ROK holds precious experience in overcoming national crises with the aid of the international community and grew to become a responsible member of international society. President Lee Myung-bak established the goal of 'contributing actively to resolving global issues' and has dispatched ROK military service members to the world's major conflict regions, and through such service members, the ROK engages in cease-fire monitoring, reconstruction aid, and anti-piracy operations. As of November 2010, 1,195 ROK service members have been deployed to 17 regions in 14 countries to engage in UN and multi-national forces peacekeeping operations. The ROK Government intends to gradually expand the scale of its participation in international peacekeeping operations.

### 1. Participation in UN Peacekeeping Operations

UN Peacekeeping Operations (PKO) began when the United Nations Truce Supervision Organization (UNTSO) in Palestine was established in 1948 for the purpose of peacefully resolving international disputes. Over the course of sixty years, a total of one million men and women from 120 nations have been deployed to 60 regions to perform tasks such as truce supervision in conflict regions, reconstruction aid and other similar tasks, and as of November 2010, about 99,000 men and women are deployed to 19 regions in 18 countries to perform their missions.

After joining the UN in 1991, the ROK began participating in UN PKOs in July 1993, when it sent an engineering unit to the UN Operations in Somalia (UNOSOM II). The ROK has dispatched around 5,000 service members to 16 countries since 1993. In November 2010, it sent the 359-strong Dongmyeong Unit to Lebanon and the 240-strong Danbi Unit to Haiti; a total of 640 Korean service members are active in UN peacekeeping operations. The ROK's participation in PKOs is shown in Figure 4-2.

Classification	UN PKO	MNF PO
Host	Led by the UN	Led by a regional security organization or a particular nation
Command and Control	Peacekeeping Forces Commander appointed by the UN Secretary General	MNF Commander
Expenses	Reimbursement by the UN	Borne by participating nations

- ▶ Appendix 9 Status of UN Peacekeeping Operations
- ▶ Appendix 10 Budgets per Dispatched Unit
- ▶ Appendix 11 Status of Overseas Dispatch of the ROK Forces

Figure 4-2. Current Status of ROK Armed Forces' UN PKO Participation

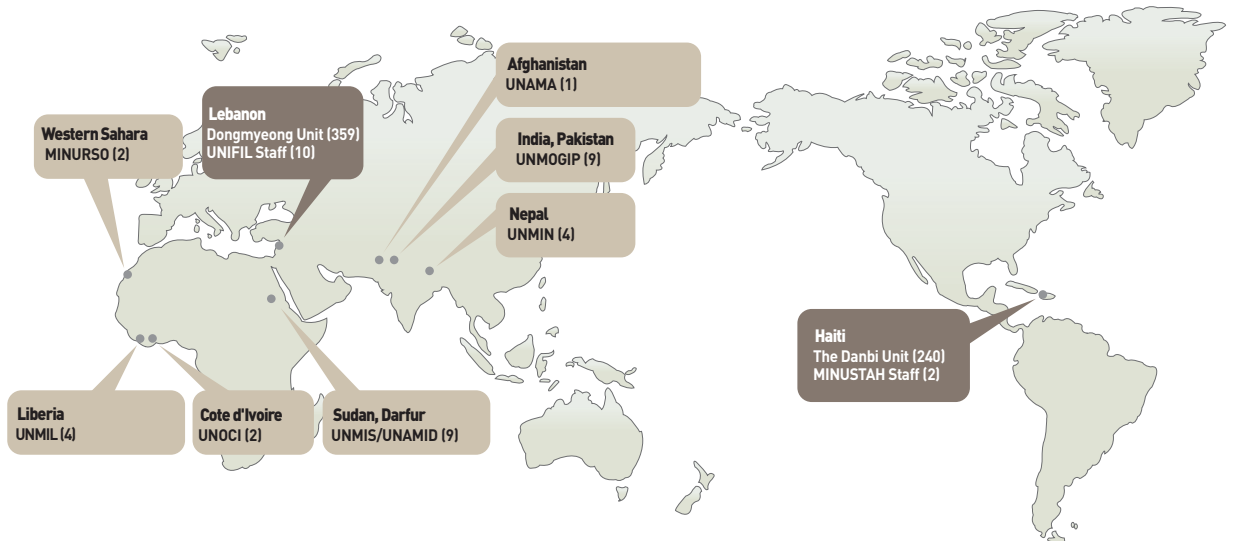

**| Lebanon - the Dongmyeong Unit |** In 1975, a civil war erupted between the Christians and Muslims in Lebanon. The Syrian military in 1976 and the Israeli military in 1978 were each deployed and camped in Lebanon under the pretext of settling the civil war. As a result, there were frequent conflicts between the Christian militia, Islamic militia, the Lebanese Government's forces, Syrian military, and the Israeli military. Consequently, the UN passed UN Security Council Resolutions 425 and 426 in March 1978 and established the UN Interim Forces in Lebanon (UNIFIL), which then began its supervision of the cease-fire between Lebanon and Israel.

In 2006, in the southern region of Lebanon, terror and attacks were occurring continuously, and more than 1,000 civilian casualties occurred due to the conflict between Israel and Hezbollah; as the situation worsened, the UN adopted UN Security Council Resolution 1701 on August 11, 2006, whereby the UN sharply increased the number of Lebanon peacekeeping forces from 2,000 to 15,000 and requested the active participation of its member states.

In July 2007, the ROK Government sent 350 troops to the United Nations Interim Forces in Lebanon (UNIFIL) (the Dongmyeong Unit), with the approval of the National Assembly. The Dongmyeong Unit began cease-



The Dongmyeong Unit participating in truce supervision in Lebanon (Tyre, Lebanon, March 2010)

fire monitoring with respect to Israel and Lebanon in Tyre, in the southern region of Lebanon.

In addition to its truce supervision activities, the Dongmyeong Unit has been engaging in multi-functional civil operations called the Peace Wave.<sup>1</sup> Under this program, the Dongmyeong Unit attends to the needs of local residents, provides medical and quarantine services, paves roads, improves schools and public facilities, etc. The unit has also opened Taekwondo, Korean, and computer classes in order to strengthen the nation’s ties with the local residents. The major achievements of the Dongmyeong Unit are shown in Table 4-3.

**Table 4-3. Major Activities of the Dongmyeong Unit (as of November 2010)**

Operational Activities	<ul style="list-style-type: none"> <li>Operational activities supervision and reconnaissance of the site of operational activities: 11,676</li> <li>Combined reconnaissance with the Lebanon military: approximately 637, joint guard support for checkpoints:1,931</li> </ul>
Reconstruction Aid	<ul style="list-style-type: none"> <li>Medical support for local residents: 26,644 persons/5 times/week</li> <li>Treatment of livestock: 4,230, and quarantine activities:5 times/week</li> <li>Computer, Hangul, Taekwondo and sewing classes: 5 sites</li> <li>Support of educational institutions within the area of operations: 15 schools</li> </ul>
Military diplomacy	<ul style="list-style-type: none"> <li>Exchanges with UNIFIL participant nations: 191</li> <li>Public affairs campaign through local and Korean domestic press: avg. 32 per month</li> </ul>

**| Haiti - the Danbi Unit |** In February 2004, public order in Haiti, a nation in the Caribbean Bay in Central America, deteriorated due to massive riots. In response, the United Nations (UN), pursuant to UN Security Council Resolution 1542, sent a multi-national force led by the United States and quickly resolved the matter. In June 2004, the UN established the United Nations Stabilization Mission in Haiti (MINUSTAH), which has since been maintaining public order.

On January 12, 2010, an earthquake that measured 7.0 on the Richter scale occurred in Haiti and the capital city of Port-au-Prince and the surrounding areas were reduced to ruins, which gave rise to millions of refugees. The UN, through UN Security Council Resolution 1908, increased the number of troops deployed to MINUSTAH from 6,940 to 8,940 and requested the active participation of its member states.

The ROK Government decided to dispatch an engineering unit to Haiti in

### 1. Peace Wave

This is DongMyeong Unit’s Multi-functional Civil Operations, which include: ① repairing and refurbishing dilapidated School buildings ② building and repairing roads ③ providing medical assistance to local residents.



A Danbi Unit campsite (April 2010)

order to assist in the recovery and reconstruction of the nation. With consent from the National Assembly, on February 27, 2010, the ROK sent the 'Haiti Reconstruction Support Group' (Danbi Unit) comprised of 240 personnel. The Danbi Unit is organized as shown in Figure 4-3.

Figure 4-3. Organization of the Danbi Unit

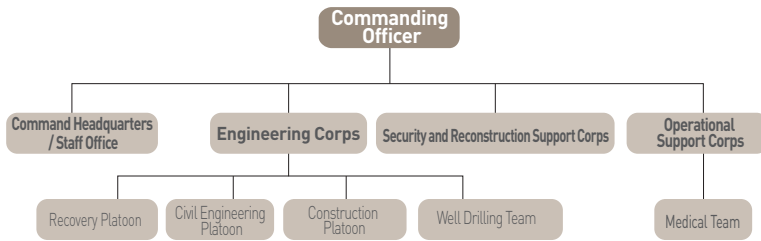

The Danbi Unit engages in activities such as removing the debris from damaged buildings, restoring roads, drilling wells, dredging waterways, providing medical assistance, and quarantine assistance in the Leogane region, where almost all the buildings were destroyed by the earthquake.

Also, the Danbi Unit has been actively engaging in military cooperative activities with the units deployed by other nations, such as removing the debris from the Notre Dame de Petit Elementary School in tandem with the engineering unit sent from Japan. Major activities include those shown in Table 4-4.



The Danbi Unit performing restoration work (June 2010)

Table 4-4. Major Activities of the Danbi Unit (as of November 2010)

Reconstruction assistance	<ul style="list-style-type: none"> <li>• Reconstruction of the Leogane-Jacmel Road: 4 sites</li> <li>• Removal of building debris: 9 sites</li> <li>• Drilling of deep wells: 9 sites</li> <li>• Dredging of waterways: 13 times</li> </ul>
Medical assistance	<ul style="list-style-type: none"> <li>• Medical assistance to local residents: 11,724 persons</li> <li>• Assisting in quarantining activities in refugee camps: 95 times</li> </ul>
Military diplomacy	<ul style="list-style-type: none"> <li>• Military exchange and cooperation with units dispatched from other nations: 47 times</li> </ul>

**| Activities as observers and staff in UN Missions |** The ROK Government has dispatched around 41 observers and staff officers to UN missions in major areas of conflict, such as in India, Pakistan, Lebanon, Sudan, Afghanistan and Haiti. Observers monitor cease-fire violations and

take part in patrols, investigations, reports and mediation efforts, under the command of the local mission. The staff officers are a part of the staff office of each command headquarters and perform staff duties regarding certain areas, such as intelligence, operations, and logistics.

## 2. Peace Operations of Multi-National Forces

The multi-national forces peace operations include conflict resolution, establishment of peace, reconstruction assistance, etc., which are carried out by a multi-national force formed by regional security organizations, or a particular country, pursuant to a UN Security Council Resolution or the support and resolution of the international community; together with the UN PKO, it plays an important role in the stabilization and reconstruction of a troubled region.

As of November 2010, the ROK Government has deployed a total of 555 personnel to the Cheonghae Unit in the waters of Somalia and to the Ashena Unit in Afghanistan, thus contributing to MNF PO. The details of the ROK's participation are shown in Figure 4-4.

Figure 4-4. Details of the ROK Military's participation in MNF POs

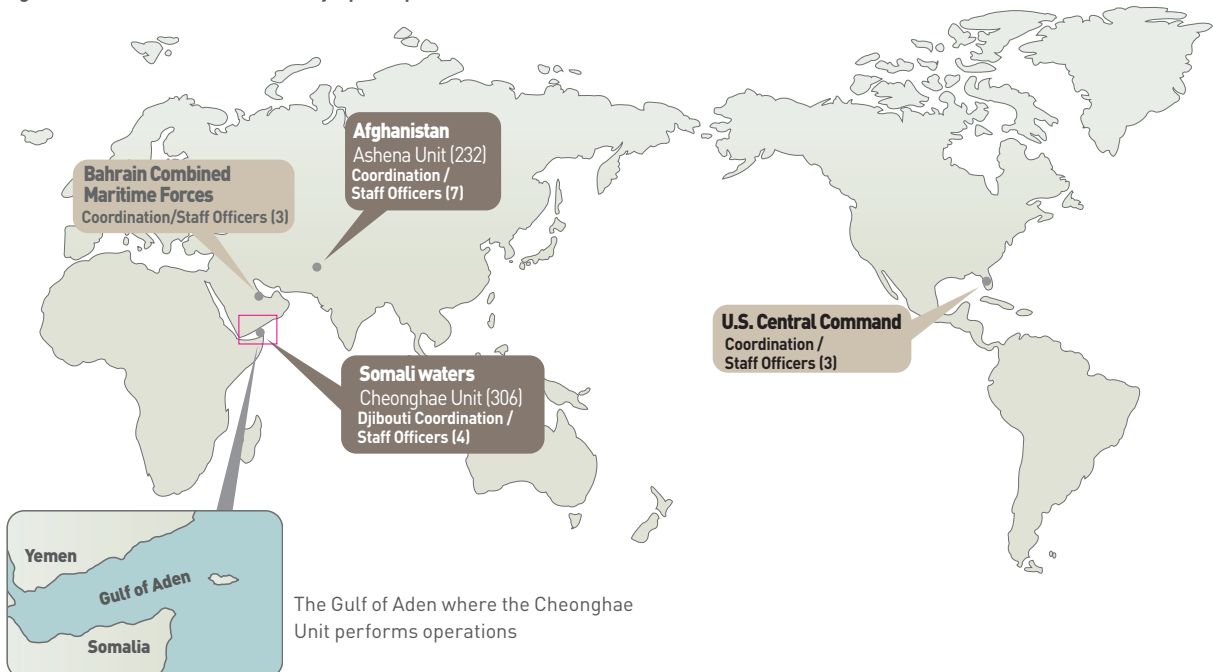

**| The Cheonghae Unit in the Somali waters** | Somalia has long been undergoing civil strife, which has destabilized public order and brought about chronic economic difficulties. As a result, since 2004, the local fishermen, under the protection of the regional warlords, created piracy organizations and have begun to engage in piracy in the Somali waters.

Following a sharp increase in piracy, the UN Security Council passed Resolution 1816 in June 2008 by which the UN decided that member states would dispatch naval vessels and aircraft and also requested the participation of its member states. The ROK Government, with the approval of the National Assembly, dispatched the Cheonghae Unit to the Gulf of Aden off Somalia on March 13, 2009.

The Cheonghae Unit's mission is to assist in the safe passage of ROK Ships and to perform anti-piracy operations by participating in the Combined Maritime Forces. The Cheonghae Unit is comprised of one 4,500t destroyer, one helicopter, three RIB (Rigid Inflatable Boats) and about 300 personnel. Since the ROK Ship Munmu The Great was dispatched in March 2009, ROK naval vessels have been rotating every six months.

The Cheonghae Unit performs round-trip convoys once every week, mainly for Korean ships that pass through the Gulf of Aden. It participates in CTF-151<sup>2</sup> and engages in anti-piracy operations. In the course of these operations, it has rescued 10 civilian ships that were under threat from pirates.

The Cheonghae Unit also contributes to the expansion of the outer boundaries of military cooperation by reciprocating visits with naval vessels from other dispatching nations, such as the U.S., Turkey, Japan, China, India, and France, and also takes part in conferences to exchange information regarding piracy.

**| The Ashena Unit in Afghanistan** | After the dissolution of the Taliban Government in 2001 and the indiscriminate terror instigated by the Taliban, public order in Afghanistan worsened drastically, and the UN therefore passed UN Security Council Resolution 1383 and established the International Security Assistance Force (ISAF) to support the stabilization and restoration activities in Afghanistan. Through UN Security Council Resolutions, the UN has annually pressed its member states to support the ISAF, and through Resolution 1890 passed in October 2009, it requested



The Cheonghae Unit undergoing maritime exercises (April 2010)

## 2. CTF-151 (Combined Task Force-151)

This unit is under the control of the Combined Maritime Forces, which is solely responsible for anti-piracy operations in the Gulf of Aden and the Somali waters.

► See Appendix 12 Nations Participating in the ISAF

that member states contribute personnel, equipment and materials to the ISAF.

The ROK Government announced at the end of October 2009 its plans to operate the Korean Provincial Reconstruction Team (PRT) and to dispatch protective units, and with the approval of the National Assembly in February 2010, the ROK Government sent the Ashena Unit, as a reconstruction aid team, to Parwan Province, Afghanistan, in July 2010. Beginning in July 2010, the Korean PRT has been performing reconstruction work in various areas, such as public health, medical aid, education, administrative systems and rural development, under the lead of civilian experts. The Ashena Unit patrols the sites of PRT deployments and protects PRT activities. The organization of the Afghan Ashena Unit is shown in Figure 4-5.



The Ashena Unit protecting members of the Provincial Reconstruction Team (July 2010)

Figure 4-5. Organization of the Afghan Ashena Unit



**| Multi-national forces staff and coordination officers |** The ROK military has sent 17 staff and coordination officers to support the multi-national forces in each military unit. Seven service members have been sent to the Combined Maritime Forces in Bahrain and CJTF-HOA in Djibouti in order to support the Cheonghae Unit. Seven service members have been sent to Bagram and Kabul in Afghanistan in order to support the Ashena Unit. Three have been sent to the US Central Command.

In addition, from April 21 to August 31, 2010, a ROK Navy Admiral, as commanding officer, has successfully led the MNF CTF-151 unit, a unit dedicated to carrying out anti-piracy operations in the Gulf of Aden and the eastern Somali waters.



### 3. Expansion of PKO Participation

The ROK Government intends to firmly establish its military readiness posture and, at the same time, steadily expand its participation in international peacekeeping operations. To this end, it is establishing the foundation for the dispatch of troops and is expanding its participation in PKO-related, multi-national exercises.

#### | Establishing the basis and system for overseas dispatch of troops |

The ROK Government's efforts at establishing the basis and system for the dispatch of troops can be summarized into the following: the operation of standing units for overseas deployment, enactment of the UN PKO Participation Act, and reinforcing the functions of the Military PKO Center.

First, the standing units for overseas deployment have been designated and operated since December 2009 and remain 3,000 strong. These units are comprised of one unit dedicated to overseas deployment, one designated reserve unit, and one unit designated separately; each type of unit is comprised of 1,000 service members. The unit dedicated to overseas deployment is the first to be deployed in the event of such request. Until June 2010, a special mission team, under the Special Warfare Command, was designated and operated as such a unit; in July 2010, this unit was dissolved and the International Peace Support Force (Onnuri Unit)<sup>3</sup> was established, resulting in a stronger readiness posture for the deployment of troops. The unit designated in advance prepares its members to replace previously deployed troops or to be sent as reinforcements; four battalions have been so designated under the Special Warfare Command. The units designated separately are those that remain ready for various deployment related activities, including engineering units, medical units, and military police, and the Navy and Air Force transport units that have been designated for such a purpose. The International Peace Support Group prepares for and trains itself to be ready for deployment within one month after a request is made to deploy; once deployment has been decided, a new unit for deployment is established within the original unit and dispatched upon the approval of the National Assembly. The organization of the standing units for overseas deployment is shown in Figure 4-6.

#### 3. The Onnuri Unit

'Onnuri' is a Korean word which is a combination of 'on' meaning 'all' or 'whole' and 'nuri' meaning 'the world' where we are living in. This unit spans the world, opting for peace and hope.

Figure 4-6. Organization of the standing units for overseas deployment

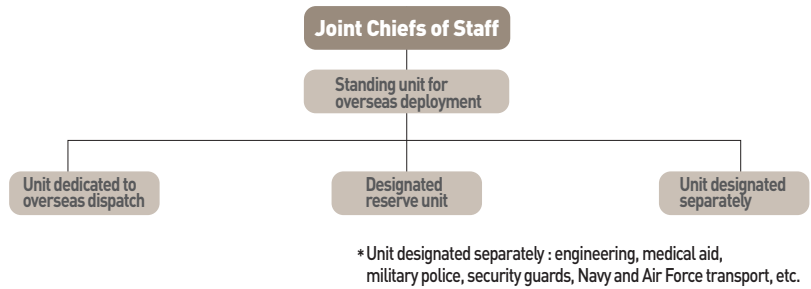

Second, in December 2009, the Act on Participation in UN Peacekeeping Operations (Appendix 13) was enacted to provide the legal basis for efficiently carrying out the deployment of troops to UN PKOs. Pursuant to this act, the ROK Government has the authority to tentatively agree with the UN to send up to 1,000 troops prior to the approval of the National Assembly; this is expected to shorten the period of time required to prepare for a deployment.

Third, the mission of the PKO Center, which is in charge of training the personnel to be deployed overseas, has been strengthened. The MND moved the PKO Center from the Joint Staff College to the National Defense University on January 1, 2010. Also, it plans to increase the number of PKO Center staff from 19 to 29 by 2013 and increase its educational and research functions. The organization of the PKO Center is shown in Figure 4-7.

Figure 4-7. Organization of the PKO Center



### | Expansion of participation in multilateral PKO training and exercise |

The MND is expanding its foreign exchange and cooperation activities by participating actively in international PKO-related multi-national training and exercises. Every year, since 2006, Korea has participated in the 'Khann Quest'<sup>4</sup> Multilateral PKO Exercise led by the Mongolian Government

#### 4. Khann Quest

Khann Quest refers to multilateral PKO training and exercises that focus on humanitarian civil affairs operations, held in Mongolia.

and has applied the UN PKO training directives and the standard training model. Also, every year since 2008, it has participated in the GPOI Capstone Exercise<sup>5</sup> and engaged in PKO CPX and FTX together with the other participants. In February 2010, our Navy and the Marine Corps participated, for the first time, in the six-nation Cobra Gold Exercise and engaged in multi-national combined operations and humanitarian civil affairs operations training together with other countries, including the U.S. and Thailand.

**5. GPOI (Global Peace Operation Initiative) Capstone Exercise**

It is a PKO multi-national training and exercise that focuses on humanitarian activities. It has been held every year since 2008, pursuant to U.S. President George W. Bush's June 2004 proposal of the Global Peace Operation Initiative.



Joint Administrative Area in the Western Corridor



# Chapter 5

## Military Support to Advance Inter- Korean Relations

**Section 1.** Inter-Korean Military Confidence Building  
and Arms Control

**Section 2.** Repatriation of ROK POWs and Joint  
Remains Recovery

# Inter-Korean Military Confidence Building and Arms Control

Aiming to build a practical foundation for peace and unification of the Korean peninsula, the ROK Government has adhered to a basic principle that through sincere dialogue and cooperation it will resolve inter-Korean issues, while pursuing a North Korea policy that brings mutual benefits and common prosperity for both Koreas. In accordance with the above mentioned principle of the ROK Government toward North Korea, the Ministry of National Defense (MND) has endeavored to relieve military tension, for instance, preventing armed conflicts to build mutual trust. In addition, it will provide military assurance for inter-Korean exchanges and cooperation. Furthermore, the MND will maintain military stability on the Korean Peninsula through arms control, while backing the creation of a new peace regime on the defense front.

## 1. Military Confidence Building through South-North Military Talks

| **South-North military talks** | From the beginning of the Lee Myung-bak Administration, North Korea has continued to take tough measures against the South as it deemed the North Korea Policy of the ROK Government hostile and offensive. For instance, North Korea defined the ROK-U.S. combined exercise (KR/FE) conducted beginning on March 9, 2008, as "war provocative schemes." Concurrently, the North cut off South-North military communications lines and restricted land crossing to the North. On March 29 of the same year, the North unilaterally notified the South that it would cease all contact and dialogue with the ROK Government and completely ban South Korean officials from crossing the Military Demarcation Line (MDL). In the meantime, an incident added to the tension between the two Koreas; a South Korean tourist was shot and killed on Mt. Kumgang by a North Korean soldier on July 11.

On October 2, 2008, the 37<sup>th</sup> South-North Military Working-Level Talks

was held at the request of the North. However, the North threatened that ongoing inter-Korean exchange and cooperation projects would not proceed as planned due to civilian groups' flying leaflets into North Korea. In fact, on December 1, the North took several measures to limit crossings between the South and the North; it restricted the crossing of the Military Demarcation Line (MDL), suspended the Kaesong tourism, ceased the operation of the South-North railway and restricted inter-Korean land crossing.<sup>1</sup>

In 2009, North Korea continued its hard-line stance against the South. On January 30 of the same year, a statement by a spokesperson of the Committee for the Peaceful Reunification of the Fatherland announced that it would nullify all agreements concerning the resolution of inter-Korean political and military confrontation while terminating the provision on the West Sea Military Demarcation Lines, which are contained in both the Inter-Korea Basic Agreement and the Auxiliary Agreement on Non-aggression. In addition, North Korea took provocative actions, including the launch of a long-range missile on April 5, a second round of nuclear tests and the launch of a short-range missile on May 25, which increased the tension between the two Koreas. Although North Korea briefly softened its stance in August 2009, it staged the Daecheong Naval Campaign on November 10. After this provocation, it designated an area so-called the Maritime Firing Zone established in the West Sea on December 23.

The North's provocative actions persisted into 2010. In January and February, it declared a "No-Sail Zone" in the West Sea and fired artillery, which led to an escalation of military tension. Meanwhile, on March 2, a South-North Military Working-Level Talks to discuss 3Cs (crossing, communications, and custom clearance) concerning the Kaesong Industrial Complex was held at the North's request. However, on March 26, the ROK Ship Cheonan was sunk by torpedo attack of a North Korean midget submarine, resulting in a reduction in inter-Korean trade and exchanges along with the suspension of dialogues and contact between the authorities of the two Koreas.

The ROK Government urged North Korea to reveal the truth behind the

#### 1. December 1 Restrictive Measures

- A reduction in the number of South Korean residents in the North: restricted to 880 people in Kaesong and 100 on Mt. Kumgang.
- Suspension of railway cargo transport between Munsan and Bongdong and of the Kaesong tourism.
- Reduction of other forms of land crossing: Across the Western Corridor, nineteen crossings per day went to six crossings per day. Across the Eastern Corridor two crossings per day went to one crossing per week.
- Heightened emphasis on the order of crossing and customs clearance.

## 2. Real estate in the Mt. Kumgang Tourist Region confiscated or frozen by North Korea

- Confiscated: ROK Government-owned family reunion center and fire station; the Korea Tourism Organization-owned arts performing and cultural center; a hot spring resort; and duty free shops.
- Frozen: All private properties owned by South Koreans.



The 38<sup>th</sup> South-North Military Working-Level Talks (Peace House, Sept. 30, 2010)

death of the South Korean tourist on Mt. Kumgang while demanding that the North give assurances that similar incidents would not occur and measures to guarantee the safety of South Korean visitors would be taken.

Nevertheless, on April 23, North Korea confiscated ROK state-owned properties in the Mt. Kumgang Tourist Region while freezing<sup>2</sup> private property owned by South Koreans on April 27. In addition, the North publicly confirmed the complete severance of South-North relations one day after the ROK Government announced its countermeasures against North Korea's attack on the ROKS Cheonan on May 24. In addition, North Korea fired artillery towards the south of NLL (Northern Limit Line) in the West Sea on August 9, heightening military tension on the Korean Peninsula.

However, North Korea replaced its hard-line policy with a softened stance as the ROK's humanitarian assistance for the North's food victims started in mid-August. The North proposed a new round of reunion for separated families. Accordingly, inter-Korean Red Cross talks proceeded to arrange flood aid and a family reunion, while the 38<sup>th</sup> South-North Military Working-Level Talks was held on September 30 at the North's request.

At the meeting, South Korea strongly urged North Korea to acknowledge its responsibility for the sinking of the ROK Ship Cheonan; to apologize; to punish the personnel in charge; and to set up preventive measures to avoid reoccurrences. In addition, the ROK Government demanded that the North immediately put an end to its hostile acts toward South Korean maritime territories and cease slandering and defaming the ROK Government.

North Korea demanded that South Korean civilian groups cease flying leaflets into North Korea. Further they insisted that ROK naval vessels were intruding into North Korean waters. With regard to the attack against the ROK Ship Cheonan, the North reiterated its existing position "a National Defense Commission inspection team should be dispatched for investigation." A military working-level talks, which resumed two years after the previous meeting in 2008, ended up serving as a venue for each side to simply reaffirm its position on the pending issues without yielding any agreement.



Even after the military working-level talks, the North has evaded its responsibility for the ROKS Cheonan incident by announcing the so-called the ROKS Cheonan Fact Sheet and continuing its provocations against the South. On November 23, 2010, North Korea indiscriminately fired artillery rounds at Yeonpyeong Island, South Korea, citing the South's regular firing exercise as the reason. This act of provocation directly threatened and took the lives and properties of South Korean civilians. As an illegal act, the attack is no less than a definite violation of the Charter of the United Nations, the Armistice Agreement and the Inter-Korean Non-Aggression Agreement.

**| North Korea's non-implementation of inter-Korean agreements and provocations against the South** | Thus far, the two Koreas have adopted a total of 12 agreements through a series of military meetings. During the process, the North has selectively implemented agreements that serve its interest, whereas it has ignored those measures designed to relieve military tension and build military confidence.

On June 4, 2004, the 2<sup>nd</sup> Inter-Korean General Officer-Level Talks, South and North adopted the Agreement on the Prevention of Accidental Naval Clashes in the West Sea, the Cessation of Propaganda Activities and the Removal of Propaganda Related Equipment from the Military Demarcation Line (MDL) Areas (June 4 Agreement). In compliance with this Agreement so as to prevent any accidental armed clashes in the West Sea, South Korea maintained communications between the South and North Korean naval vessels through the International Merchant Marine Common Network. In addition, South and North Korea shared information about illegal fishing activities of third party nations, while ceasing its propaganda activities and removing all of the relevant equipment along the Military Demarcation Line (MDL) as agreed upon in the above Agreement.

North Korea, however, implemented only the issues it had raised—the removal of propaganda-related activities and equipment—while ignoring the agreement on the prevention of accidental naval clashes. Moreover, on condemning those South Korean civilian groups who had been flying leaflets into North Korea, which was not stipulated in the June 4 Agreement, the North threatened to re-examine the agreement on military assurance for

crossing at the South-North Joint Administrative Area.

From May 19, 2008, North Korea unilaterally stopped sharing information about the illegal fishing activities of third party nations, which was part of the Agreement aimed at preventing accidental armed clashes in the West Sea. In addition, since June 2008, the North has not responded to the South's calls made through the International Merchant Marine Common Network. Above all, the recent incidents caused by North Korea: the Daecheong Naval Campaign in November 2009; the attack against the ROK Ship Cheonan in March 2010; and the shelling on Yeonpyeong Island in November 2010 have clearly violated Article 2.2 of the June 4 Agreement.<sup>3</sup>

On May 24, 2010, in response to the North's military provocations, the ROK Government announced a series of measures to ban the navigation of North Korean vessels into South Korean waters; to suspend inter-Korean trade and exchanges; and to refer the North's provocation to the UN Security Council. Along with these measures, it also demanded that the North apologize for the incident, punish those in charge, and promise to prevent the reoccurrence of similar events. The Ministry of National Defense also announced countermeasures against North Korea,<sup>4</sup> including the resumption of anti-North Korean psychological warfare, in order to hold Pyongyang accountable, pay the price for its provocative actions and to deter further acts of provocation. The resumption of anti-North Korean psychological warfare was a legitimate measure that sent a stern warning to the North for its obvious violations against the Armistice Agreement and several inter-Korean agreements, including, the Inter-Korean Non-aggression Agreement, and other agreements pertaining to the prevention of mutual slander and defamation.

On May 8, 2007, the North and South issued a joint press release at the 5<sup>th</sup> Inter-Korean General Officer-Level Talks. In that release, North Korea agreed to join the South in the efforts to prevent the floodings of the Imjin River. However, later on September 6, it initiated, without a prior notice, a discharge of the Hwanggang Dam located in the upstream of the Imjin River. Water discharged downstream has resulted in the killing of innocent South Korean civilians. In addition, despite the agreement reached on December

### **3. Article 2.2, The June 4 Agreement**

The two Parties shall not undertake unjust physical actions against the naval and civilian vessels of the other Party.

### **4. The May 24 Countermeasures against North Korea**

- Resumption of psychological warfare against the North
- Ban on North Korean vessels entering South Korean waters
- Implementation of ROK-U.S. combined anti-submarine exercises

13, 2007 at the 7<sup>th</sup> Inter-Korean General Officer-Level Talks, an agreement to provide military assurance for 3Cs (crossing, communications, and customs clearance), the North has continually ignored its obligations by frequently restricting land crossing.

**| Future directions of South-North military talks** | The ROK Government has pursued consistent and principle-based North Korea policies in order to achieve mutually respectful and cooperative, sound, and normal inter-Korean relations.

In future South-North military talks, the Ministry will negotiate the relevant issues in phases, beginning with agenda that can be easily agreed upon and implemented. Military assurances for inter-Korean exchanges and cooperative projects and the alleviation of military tension will occupy the negotiating table as the first priority. Following this, and depending on the progress made in the negotiations on the denuclearization and the peace regime on the Korean Peninsula, operational and structural arms control issues will be discussed.

## 2. Military Assurance Measures for Inter-Korean Exchanges and Cooperative Projects

The Ministry has developed military assurance measures for inter-Korean exchanges and cooperative projects and postured to respond to any contingencies.

Since the Inter-Korean Summit in 2000, inter-Korean exchanges and cooperative projects have developed with a focus on three major economic cooperative projects: inter-Korean railway and road connections, construction of the Kaesong Industrial Complex, and the Mt. Kumgang tourism project. Since these projects were arranged through the South-North Joint Administrative Area within the DMZ, the Ministry ensures the safe crossing of the border through consultations with the United Nations Command (UNC) and the North Korean military.



Trucks carrying aid shipments of rice to North Korea pass through the Inter-Korean Transit Office in the Western Corridor (Paju, September 2010)



Inter-Korean Transit Office, Eastern Corridor



Figure 5-1. South-North crossing

**5. Designated ports for inter-Korean navigation route**

- South Korea: Incheon, Gunsan, Yeosu, Busan, Ulsan, Pohang, Sokcho
- North Korea: Nampo, Haeju, Kosong, Wonsan, Hungnam, Chongjin, Najin

**| Military assurance for inter-Korean crossing |**

Inter-Korean crossing is possible by land, air and sea as shown in Figure 5-1. Land crossing is enabled via the roads and railways that exist within the South-North Joint Administrative Area in the Eastern and Western corridors. In accordance with the Armistice Agreement and the Inter-Korean Agreement, the ROK military implements the passage plans in consultation with the United Nations Command (UNC) and the North Korean military while operating a guard post inside the South-North Joint Administrative Area and providing escort and guard services.

As for the sea crossing,<sup>5</sup> the South-North Navigation Route, which conforms to the South-North Agreement on Maritime Navigation (signed on May 28, 2004, and effective on August 1, 2005), is utilized. When approving the crossing

of a North Korean vessel, the ROK military cooperates with relevant ministries and agencies, inspects communications check, and maintains alert and surveillance posture, whenever a North Korean vessel crosses the NLL. However the sinking of the ROKS Cheonan caused the ROK Government to ban all North Korean vessels on South Korean waters as of May 24, 2010.

The air crossing between the two Koreas is taking place along the West Sea direct route. When a North Korean aircraft requests permission to cross the South Korean air-space, the ROK military decides whether to approve or deny the request considering the relevant military and national security aspects. Once approved, the ROK military ensures the safe crossing of the North Korean aircraft and prepares for possible contingencies.

**| Improvement of the inter-Korean military communications line |**

The two Koreas agreed to establish a communications line in the Agreement on Military Assurances for the Designation of the Joint Administrative Area in the Eastern and Western corridors and the Construction of Railways and Roads Connecting the South and North signed on September 17, 2002. In accordance with this Agreement, a telephone line, a fax line, and an alternate line were installed in the Western corridor on September 24, 2002;

while in the Eastern corridor, the same equipment was set up on December 5, 2003. On August 13, 2005, in accordance with provisions in the June 4 Agreement, a telephone line, a fax line, and an alternate line were established in order to prevent an accidental collision or conflict on the West Sea. Separate from crossing via the Kyeongui railway, they installed these communications lines in the Western corridors.

However, the copper cable communication lines connecting the South and the North were often disrupted due to the North's power shortages and underdeveloped infrastructure. Hence, at the Second South-North Defense Ministerial Talks held on November 29, 2007, the two sides agreed to upgrade the communication system. At the Seventh Inter-Korean General Officer-Level Talks held on December 13 of the same year, the two Koreas signed the Military Guarantee Agreement for Crossing, Communication, and Customs Clearance in the South-North Korea Administrative Area in the Eastern and Western Corridors.

As the communication line in the Western corridor was out of service on May 5, 2008, North Korea requested that South Korea provide the necessary fiber optic cables and equipment to make the repairs. The 204<sup>th</sup> Inter-Korean Exchange and Cooperation Promotion Council, which belongs to the ROK Government, agreed to carry out the Project to Improve the Inter-Korean Military Communication Lines. However, the project stalled in July when a South Korean tourist to Mt. Kumgang was shot to death by a North Korean soldier.

In October 2009, the ROK Government commenced upgrading the military communications lines in response to repeated requests by North Korea. From October 28 to November 19, 2009, the ROK Government provided, on five occasions, the materials and equipment necessary to establish and operate a fiber optic cable-based communications system in North Korea, while the two Koreas proceeded with the construction in their respective zones. Finally, on December 22, the fiber optic communications line over the Military Demarcation Line (MDL) was put into operation to connect the South and North military authorities. It has been in service since December 26, 2009, following two days of test runs that were conducted on December 24 and 25.



Construction to Upgrade inter-Korean Military Communications Lines

#### 6. Arms Control

Arms control is a strategic concept designed to enhance security and diminish the risk of war by promoting military transparency and stability through a series of measures under unilateral, bilateral, or multilateral consultations between concerned nations. These measures include reviewing, restricting, banning, and reducing the construction, deployment, relocation, operation, and use of certain military forces.

### 3. Maintaining Readiness for Arms Control Implementation between the Two Koreas

Arms control between the South and the North<sup>6</sup> is a strategic concept designed to enhance security and reduce the risk of war by promoting military transparency and stability. In advancing arms control, the ROK Government has maintained its position to pursue gradual and phase-based arms control in line with the progress being made in the negotiations on the denuclearization and the peace regime of the Korean Peninsula. It also has maintained certain principles: to prioritize the common interests in implementing arms control; to apply the principle of reciprocity; and to increase the likelihood of agreements being implemented.

In 1992, the two Koreas already agreed to build military confidence and implement arms control through cooperative discussions as stipulated in both the Inter-Korea Basic Agreement and the Auxiliary Agreement on Non-Aggression. In 2004, they adopted the Agreement on Preventing Accidental Clashes in the West Sea and Discontinuing Propaganda Activities. Despite such meaningful progress, arms control between the South and the North has not been materialized even at the elementary level of military confidence.

The Ministry has been preparing for possible discussions pertaining to disarmament depending on the progress of the negotiations on North Korean denuclearization and a peace regime on the Korean Peninsula. It has therefore engaged in multi-faceted discussions and research that have encompassed hosting arms control seminars and publishing the Arms Control in the Korean Peninsula booklet. In addition, with its Korea Arms Verification Agency spearheading the efforts, the MND has held workshops to improve disarmament verification; simulated inspection training; nuclear verification training; and educational and training programs for disarmament verification.

# Repatriation of ROK POWs and Joint Remains Recovery

Korean War prisoners were repatriated in accordance with the Armistice Agreement signed in 1953. Yet, numerous ROK prisoners of war (POWs) still remain detained in North Korea as they were excluded from the repatriation list. The ROK Government has sought appropriate solutions that befit the situations of individual ROK POWs by confirming their survival or death, arranging family reunions, addressing repatriation issues, helping ROK POWs and families who defected from North Korea to third countries safely arrive at the South, or overseeing the comfortable settlement of repatriated POWs in South Korea. In addition, the ROK Government plans to push forward with the remains recovery of ROK service members buried in North Korea.

## 1. ROK POWs from the Korean War

At the time of the Korean War, the UNC and Communist forces exchanged POWs on three occasions between April 1953 and January 1954. At that time, the UNC forces estimated that 82,000 ROK soldiers were missing in action. However, only 8,343 ROK soldiers had been repatriated from the Communist forces. It is assumed that a considerable number of ROK POWs were not repatriated but forcefully detained in the North.

From shortly after POWs were exchanged to the 1960s, through the Military Armistice Commission, UNC forces have demanded that North Korea resolve the issue of unrepatriated ROK POWs. However, North Korea has simply reiterated its position that “all of the ROK POWs had been handed over to the Neutral Nations Repatriation Commission and not a single ROK POW remained in the North.” Even during the intermittent inter-Korean dialogues that have been held since the 1970s, this issue has failed to be officially discussed.



The UNC forces and the Communist forces signing the agreement for the exchange of wounded POWs (April 11, 1953).



UNC POWs returning to the South through the Gate of Freedom after the conclusion of the Armistice Agreement

As of June 2010, based on the statements of North Korean defectors and repatriated war prisoners, the ROK Government has come up with a list of 500 ROK POWs who are believed to remain alive in the North.

### **| Identification, reunion, and repatriation of ROK POWs |**

After the return of the late Lieutenant Chang-ho Cho, a ROK POW in 1994, the ROK Government established government-wide measures for ROK POWs detained in North Korea. In addition, through various inter-Korean dialogues, the ROK Government placed the issue of identification and repatriation of ROK POWs as its top priority in light of inter-Korean reconciliation and humanitarian efforts.

At the South-North Ministerial Talks and the Inter-Korean Red Cross talks that followed the Inter-Korean Summit in June 2000, the two Koreas reached an agreement to discuss and resolve the issue of ROK POWs, alongside the separated family issue. Afterwards, at the Seventh Inter-Korean Red Cross talks in February 2006, the two sides reached an accord to 'include identification of those missing during and after the Korean War on the agenda of separated families.' Furthermore, this principle was confirmed at the 20<sup>th</sup> South-North Ministerial Talks in February 2007 and the Eighth Inter-Korean Red Cross talks in April 2007. As a result, 28 ROK POWs were identified as being alive of whom 13 were reunited with their families in the South through family reunion sessions.

The ROK Government has endeavored to safely repatriate the ROK POWs and families who defected from the North to a third country. Upon the confirmed defection of a ROK POW, and his or her family, the ROK Government protects them as it would do with a South Korean national abroad, while exerting diplomatic efforts toward their expeditious and safe repatriation. A total of 80 ROK POWs have been repatriated to the South via third countries between 1994 and November 2010. And the number of their family members who have been repatriated totals 210. For more detailed data, refer to Table 5-1 below.



Table 5-1. Number of POWs and Their Family Members Repatriated via Third Countries

(As of November 2010, Unit: No. of Persons)

Year	'94	'97	'98	'99	'00	'01	'02	'03	'04	'05	'06	'07	'08	'09	'10	Total
POW	1	1	4	2	9	6	6	5	14	11	7	4	6	3	1	80
Family	-	2	5	8	9	12	9	10	34	18	32	23	9	26	13	210

**| Assisting in the settlement of repatriated ROK POWs |** Since the end of 2008, the Ministry has been running a South Korean society adaption program to settle repatriated POWs in the South. Through the education and training provided by civilian expert organizations, repatriated POWs not only acquire the basic knowledge necessary to live in the South but also receive emotional support. The MND also frequently visits the families of the repatriated ROK POWs to identify any difficulties they might be experiencing in the settlement process and to provide practical help. Besides, the MND also holds events for returned war veterans and roundtables for repatriated POWs and their families in order to foster a favorable social environment for them.

In addition, the MND has tried to amend the Act on Repatriation and Treatment of Prisoners of War recognizing that social environments have changed since its first enactment in 2007. The amendment stipulates that reasonable improvements should be made to the assistance system for repatriated ROK POWs and that safety assurances and their respectful treatment should be ensured. Employment support for their families is also stipulated.

**| Future directions |** The Ministry will exert its utmost efforts to help ROK POWs safely return and settle in the South through well-organized and systematical cooperation across government.

First of all, the MND will continuously raise the issue of ROK POWs during inter-Korean dialogues to induce North Korea to admit to the fact that POWs still remain in the North, and to cooperate for resolving this issue. Along with the efforts for family reunion, the MND will also do its best to seek creative solutions for the issue of ROK POWs.

In addition, the MND will ensure the safety of ROK POWs and their family members who have defected from North Korea to third countries by exerting every effort to repatriate them quickly and safely to the South. To this end, the MND will continue its diplomatic efforts by reinforcing coordination and cooperation with third countries.

Considering the challenges faced by repatriated ROK POWs during settlement in the South, due to their long years of living in the North, the MND will tailor policies toward their successful settlement. Currently, repatriated POWs in the South may run into various difficulties, e.g., a failure to adapt to South Korean society and culture, difficulties in obtaining medical treatment for illnesses related to forced labor and aging, concern for their family members left behind in the North, and communication problems with their current family members in the South. The ROK Government will seek to amend the related laws and institutions, while also encouraging the private sector to develop and organize support systems which will solve the problems the Government cannot fully address.

## **2. Inter-Korean Joint Remains Recovery**

Currently, the remains of approximately 39,000 ROK soldiers are presumed to be buried across North Korea and about 13,000 buried in the DMZ. The joint remains recovery by South and North Korea would send a clear signal that the war has truly ended and that the two Koreas value human dignity over ideology.

At the Second South-North Ministerial Talks in November 2007, the two Koreas agreed to 'discuss and resolve the issue of remains recovery, based on the shared view that the issue is related to building military confidence and ending the war.' In his New Year's address in January 2010, President Lee Myung-bak expressed his strong commitment to implementing a remains recovery program through dialogues with the North so as to mark the 60<sup>th</sup> anniversary of the Korean War. President Lee also called for North Korea's active cooperation.

In order to launch this program as early as possible, the MND will establish detailed recovery plans. In addition, it will complete a map of potential locations where remains may be buried in the North by the end of 2010, based on Korean War records and various testimonies. If the two Koreas join hands in recovering these war remains, it will symbolize the alleviation of tension and inter-Korean reconciliation.



Tank Field Training (September 2010)



# Chapter 6

## Establishing Advanced Military Capabilities

**Section 1.** National Defense Reform to Build Advanced Elite Military Forces

**Section 2.** Streamlining the Military Structure

**Section 3.** Improving the Force Structure

**Section 4.** Building Up Strong Reserve Forces

**Section 5.** Establishing a Network-Centric Defense Informatization Environment

# National Defense Reform to Build Advanced Elite Military Forces

The Ministry of National Defense (MND) strives to reform national defense by building slim but strong advanced ROK military forces capable of meeting the challenges posed by the changing strategic environment of the 21<sup>st</sup> century and future warfare in general. The basic policy direction for national military reform is to change the military structure and develop a pragmatic, advanced defense operational system to counter various security threats posed at home and abroad.

The Ministry of National Defense has been revising its Defense Reform Basic Plan, incorporating the opinions garnered from defense experts and public hearings, considering the changed security environment on the Korean Peninsula and beyond, and evaluating the defense reforms that have been implemented since 2006.

## 1. Progress in National Defense Reform

The Ministry established the National Defense Reform Basic Plan in December 2005 in order to fortify its defensive capabilities and posture in a way that best befits the changing security environment and future warfare in general. This Plan is anchored in the outlook that inter-Korean exchanges and cooperation will increase and military tension will subside on the Korean Peninsula while the insecurity and uncertainty in Northeast Asia will increase due to an escalating arms race among the nations in the region.

As future warfare is expected to be network-centric warfare (NCW) born from the development of command, control, communications, computers, and intelligence (C4I) and the expansion of weapons systems with enhanced precision and destructive power, the Plan calls for an advanced military force that does not simply rely on troop numbers.

The ROK is experiencing a dwindling military manpower caused by decreasing birthrate. It also faces a growing demand for improved living conditions for servicemen; the type of which would include better barracks to suit increased income levels and cater for rapid social development, improved human rights of service members and ensure circumstances for self-study for service members.

Building a sophisticated defense mechanism and improving the service environment require an enormous budget. However, the reality of limited defense resources calls for prudent spending and innovative operations. As a result, the MND announced the National Defense Reform Basic Plan (2006-2020), which is composed of four reform areas for further implementation: expanding civilian involvement in national defense, establishing a force structure and defense system suitable for future warfare, building a low cost, high efficiency defense management system and improving the military barracks environment to suit the changing times.

After mapping out the National Defense Reform Basic Plan, the MND drew up the National Defense Reform Act in December 2006, the Enforcement Decree of the National Defense Reform Act in March 2007 and the Defense Reform Initiative Directive in January 2008. It also established the National Defense Reform Office, under direct control of the National Defense Minister in July 2007, to take charge of national defense reform.

The major achievements from the first phase of defense reform, which spanned the four years between 2006 and 2010, are as follows: In terms of military structure, the number of troops has been cut by about 33,000. The first phase of organizational reform of the Joint Chiefs of Staff has been conducted and 11 troop units have been disbanded to establish a theater operations command system. In terms of defense management, five organizations, including the Printing Depot, have been designated as Military Executive Agencies.<sup>1</sup> Military units with similar functions,<sup>2</sup> such as the Welfare Agency, Facilities Organization, Accounting Group and Printing Depot have been incorporated into one streamlined unit.

A military base modernization project to furnish barracks with individual beds was 85% complete as of September 2010. The modernization efforts slashed manpower by 1,600 and the budget by about 46 billion Korean won. Encouraged by such achievements, the Military Executive Agency scheme will be gradually expanded.

The MND has regularly been amending and complementing the National Defense Basic Plan according to the National Defense Reform Act.<sup>3</sup> The plan was amended for the first time since the inauguration of the current government in June 2009. In terms of military structure, the MND not only changed the defense system to better counter military threats, including the launch of long-range rockets by North Korea and the implications of its second nuclear test, but also modified the ROK-U.S. combined defense system in the aftermath of wartime OPCON transition. In terms of defense management reform, the plan has been altered to match the new security environment and the nation's fiscal capacity by

### 1. Military Executive Agency

A system in which military personnel or civilians are appointed to take charge of an autonomous organization dealing with the military's organization, personnel affairs and financial matters and who is then held accountable for the performance of the organization. Thus, management efficiency and the promotion of service quality are ensured.

-Organizations implementing the system: Armed Forces Capital Hospital, Printing Depot, Army 2 Logistics Unit, Navy Supply Depot and Air Force Supply Depot 40.

### 2. Incorporation of military units with similar functions

Military units with similar or overlapping functions in each branch of military service are combined to enhance efficiency in terms of manpower and budget.

### 3. Article 5, The National Defense Reform Act

The The Minister of National Defense modifies the National Defense Basic Plan based on an assessment of the defense situation at home and abroad and the results of national defense reform efforts every two and a half years.

taking into account new initiatives, including the expanded use of civil resources.

In 2010, the MND strived to supplement the National Defense Reform Basic Plan, one that both civilians and the military can consent, by analyzing the problems in implementing the Plan. The new Plan is aimed at building defense capabilities that can offset the present and potential threats from North Korea and improve the efficiency and economy of the nation's defense readiness. The MND is committed to making such a plan feasible.

## **2. National Defense Reform Basic Plan 2009-2020**

**| Military structure reform** | Reforming the structure of the military is intended to build the military suitable to proactively cope with the security environment on the Peninsula and efficiently conduct future warfare. The reform has been conducted in four areas: command structure, unit structure, troop structure, and force structure.

Command structure reform is to establish an efficient military command system that allows ROK forces to take the initiative in war planning, preparing for theater operations after wartime OPCON transition, and to establish a new combined defense system by setting up a military cooperative organization for ROK-U.S. combined operations.

Unit structure reform reduces the number of units and streamlines the mid-tier command elements, in view of the future operational environment, so that operations can be conducted in a prompt manner. The reform will foster completeness and improve the capabilities of the combat troop organizations with a reduced number of troops.

Troop structure reform allows for a shift to a technology-intensive structure supported mainly by officers and NCOs since securing skilled soldiers has become problematic after the decision to reduce soldier's service terms. Combat forces will be mostly composed of active duty personnel whereas non-combatant functions will increasingly be replaced by civilian resources. The size of a standing force will be gradually adjusted in consideration of the capabilities of the existing weapons and equipment. Reserve forces will be streamlined by improving its training system and be postured to mobilize immediately in order to maintain combat readiness.

Force structure reform seeks to secure the optimum forces by equipping the ROK army to cope with future threats as well as those of the present, such as infiltration and local provocations by the North. Force structure reform is focused on reinforcing jointness and securing the necessary war capabilities.



**| Defense management reform** | Defense management reform will shift all of the defense management areas, including organization, personnel and budget, to a pragmatic and advanced defense operational system that will be operated at lower cost and higher efficiency. The reform will focus on optimizing defense resources, enhancing defense efficiency, establishing a customized personnel management system to train and secure the necessary personnel, improving the barracks environment and welfare, pursuing defense informatization and establishing a firm foundation for defense science, technology and capabilities. The directions being taken by defense management reform are as follows:

First, the reform will establish an efficient management and maintenance system for equipment by improving the logistics and transportation systems and utilizing civilian resources. Advanced private management techniques will be introduced to the defense management and military executive agency systems in which a consigned management system will be actively implemented. Units with similar or overlapping functions in each Service will be consolidated and streamlined. Excessive and superfluous troops will be merged into the combat contingent. Military units across the nation will be relocated to increase efficiency. Efforts will be made to increase the economic value of the land for military use.

Second, the MND will improve the recruitment system to ensure expert personnel are secured and establish a customized personnel expertise resources system. It will also reinforce education on jointness in the curriculum of Service colleges, improve the standard of education in the Joint Staff College and rebuild the mental strength education system.

Third, the MND will continue to furnish barracks with beds and improve the welfare system for service personnel in line with the development of the nation. A productive military service for service members will be fostered by providing them with opportunities for self-development by obtaining academic credits and vocational credentials. It will also develop a military medical service system providing quality medical care both in war and peace times. It will pay heed to improving the welfare benefits for family members of service members as well.

Fourth, the MND will establish an advanced defense informatization environment in preparation for future warfare based on the defense architecture.<sup>4</sup> The Ministry will expand the joint participation of academic, industrial and research institutes to independently develop cutting-edge weapons system and the core technology necessary to strengthen the defense industry.

#### **4. Defense architecture**

Defense architecture is the comprehensive informatization design that presents the vision and goals of national defense based on the scientific, structural and integrated analysis of the nation's defensive capabilities. The defense architecture is to be used as a tool for identifying the priorities in informatization, preventing overlapping investment and guaranteeing mutual operation.

# Section 2

## Streamlining the Military Structure

Military Structure Reform,<sup>1</sup> part of the Defense Reform Basic Plan, is a prerequisite for establishing an elite (slim but strong) military. The ROK military will be shifted towards becoming a technology-intensive organization in preparation for various and complex security threats. In terms of command structure, the MND will fortify the function of the Joint Chiefs of Staff to establish the ideal theater operations execution system for the new combined defensive system that has been established in preparation for wartime OPCON transition. In terms of troop structure, the MND will reinforce the troops by reinforcing the officers capable of managing state-of-the-art military combat equipment efficiently. Troop size will be curtailed gradually in line with the yearly Military Structure Reform Plan. Unit structure will be optimized in terms of the battlefield environment and the mission and role of each Service.

### 1. Command Structure

**| Establishing a theater operations execution system after wartime OPCON transition |** The new combined defense system, following the transition, will evolve into an ROK-supported and US-supporting operational system. The execution of the theater operations system is shown in Figure 6-1.

Figure 6-1. Execution of the Theater Operations System after wartime OPCON Transition

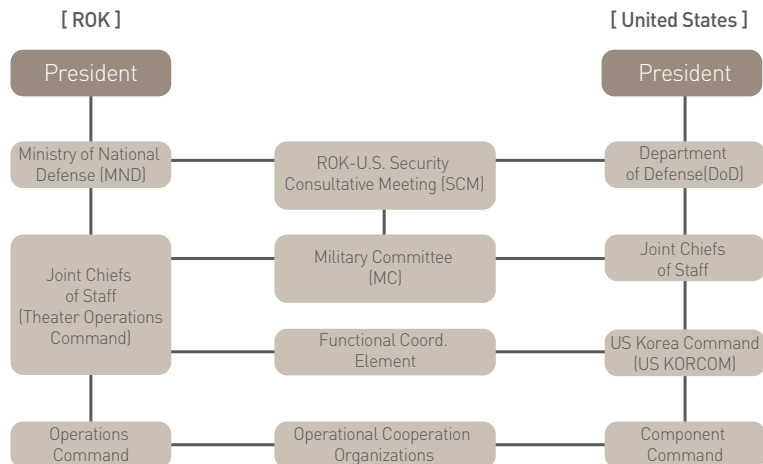

#### 1. Military Structure

Military structure refers to the overall organization of the nation's defensive resources concerned with conducting military missions. It is classified as command structure, unit structure, troop structure and force structure.

Under the new combined defense system, various cooperative organizations will be established by function or echelon in order to deter the outbreak of war on the Korean Peninsula and execute theater operations in wartime. The existing strategic channels of dialogue, such as the ROK-U.S. Security Consultative Meeting (SCM) and the Military Committee, will be maintained. The Joint Chiefs of Staff, in command of theater operations, will operate cooperative bodies in the areas of information, operations and logistics so as to secure smooth operational cooperation with US KORCOM. Operational commands, such as the Ground Operations Command, Naval Operations Command and Air Force Operations Command, and the units under each Command, will operate cooperative bodies with their counterparts in the U.S. military to secure efficient combined operations.

**| Strengthening the function and jointness of the Joint Chiefs of Staff** | The organization and functions of the Joint Chiefs of Staff have been gradually reinforced so that the Chairman of the Joint Chiefs of Staff can now command all operations during war and peace times following wartime OPCON transition. Two Vice Chairmen will be placed under the command of the Chairman of the Joint Chiefs of Staff: one in charge of supporting operational command and the other in charge of supporting military command,<sup>2</sup> outside of operational command, respectively.

Considering the changing security environment, including the wartime OPCON transition, the Joint Chiefs of Staff will reinforce its staff office to take the lead in the execution of theater operations and to increase jointness. The changed command structure for the Joint Chiefs of Staff is shown Figure 6-2.

## 2. Military Command

Military command refers to the employment of forces, the planning of military strategies, the generation of force requirements, the establishment of operational plans, and the command of operations and operational units to achieve defense objectives.

Figure 6-2. Organization of the Joint Chiefs of Staff

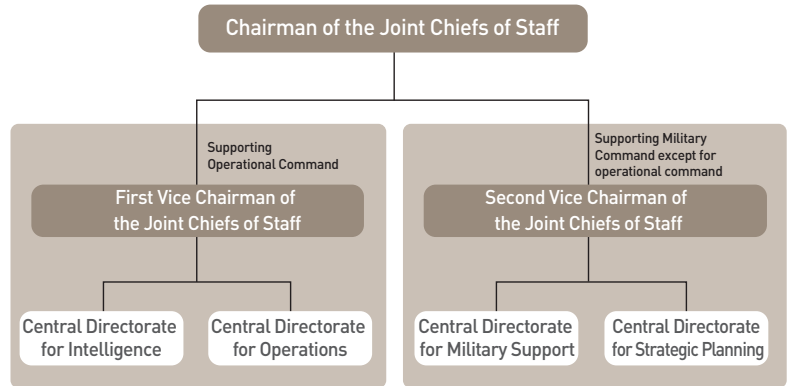

\* Chief of Central Directorate of Intelligence concurrently serves as Director of Korea Defense Intelligence Agency

## 2. Troop Structure

The ROK forces are 648,000 strong as of 2010. The number of troops has been reduced by 33,000 since defense reform started in 2005. The original Defense Reform Basic Plan purported to reduce troop number to 500,000 by 2020. The Defense Reform Basic Plan was revised in 2009 so that troop number would instead be reduced to 517,000 by 2020 in consideration of the changed security and defense environments. The yearly troop size will remain adjustable in tandem with the military's structural reform. Troop

Figure 6-3. Scheduled Target Troop Size According to the Defense Reform Basic Plan

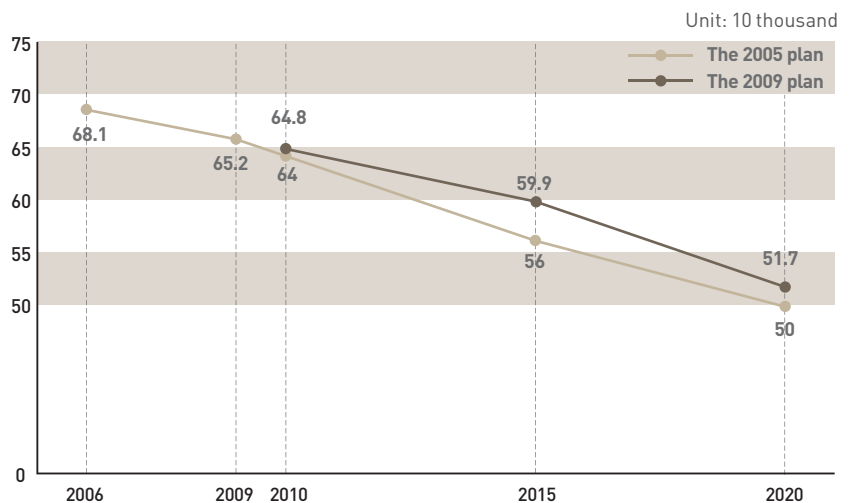

size by year is shown in Figure 6-3.

Troop structure will be reorganized to create a lean force centered on officers and NCOs, which would allow sophisticated defense capabilities to be managed efficiently and combat capabilities maximized. Use of active duty personnel in non-combat areas will be curtailed. Organizations with similar functions and roles will be integrated. Unit composition will be adjusted in light of the evaluation of individual threats that may require additional troops and troop-based missions.

### 3. Unit Structure

**| Army |** The ROK Army is transforming its force structure by reinforcing its command and control capability so that target detection, decision making, and strikes can be executed in real time. The army is also strengthening its mobility, survivability, firepower and precision level so that network-centric warfare can be performed. The scheduled major changes in the unit structure of the army are shown in Figure 6-4.

Figure 6-4. Changes of the Unit Structure of the ROK Army(from 2010 to 2020)

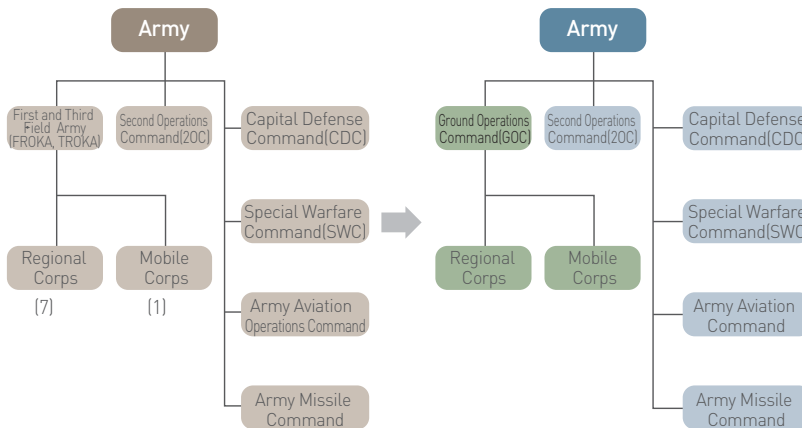

The ROK Army will replace the First and Third Field Army with the Ground Operations Command in 2015. In 2005, two out of ten corps were disbanded. Currently, there are eight corps, including seven regional corps and one mobile corps. In the future, the optimum number of regional corps and mobile corps will be maintained based on the evaluation of the specific threats.

### 3. Maritime Task Flotilla

Maritime Task Flotilla acts to deter North Korea and also carries out offensive operations, the defense of core territorial waters against potential threats, the safeguarding of SLOCs, strikes against strategic targets and the support of flotillas.



Establishment ceremony of the Maritime Task Flotilla Seven of the Navy (Busan, Feb. 2010)

**| Navy |** The ROK Navy is bolstering its surface, submarine, and aerial operational capabilities. The Navy will not only protect the nation's territorial waters but also safeguard national interests, such as the sea lines of communication (SLOCs) and marine resources in the high seas. The naval force structure will be composed of three Fleet Commands, a Maritime Task Flotilla,<sup>3</sup> a Submarine Flotilla, and an Air Wing. The Submarine Flotilla will be replaced by the Submarine Command in the future. The scheduled force structure of the Naval Operations Command is shown in Figure 6-5.

Figure 6-5. Scheduled Change in the Force Structure of the Naval Operations Command (from 2010 to 2020)

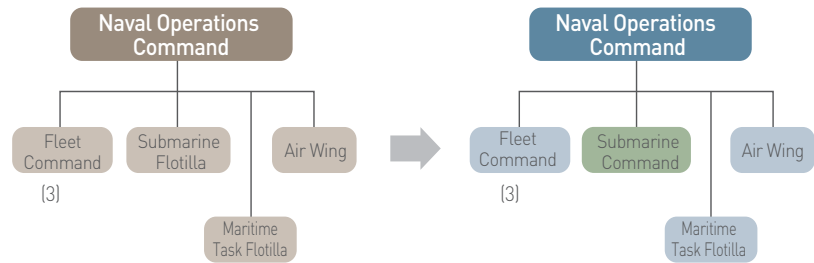

The nation's Navy will shift towards obtaining a mobile force structure by reducing the number of surface ships and dispatching its middle- and heavy-class ships to counter various threats, including the threat of the North. The capacity for submarine and air warfare will also be reinforced. Marine Corps will be reorganized into an air-to-land mobile force structure that is applicable to a range of mission types, such as three-dimensional high-speed landing operations, rapid response operations and ground operations.

**| Air Force |** The ROK Air Force is being developed to achieve air supremacy at the initial phase and to develop precision strike capabilities. To fulfill its mission, the Air Force will gain the ability to conduct surveillance of enemy movements and launch punitive retaliation. It will also secure an operational capability that encompasses the entire Korean Peninsula. The scheduled changes in the unit structure of the ROK Air Force Operations Command are shown in Figure 6-6.

Figure 6-6. Scheduled Changes in the Unit Structure of ROK Air Force Operations Command (from 2010 to 2020)

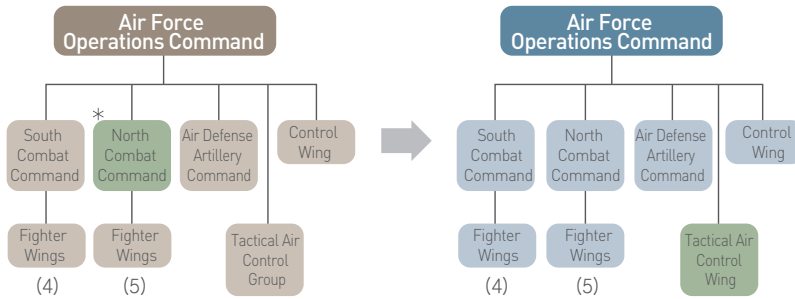

\* Established in December 2010

As for the unit structure of the Air Force, the North Combat Command will be established in consideration of the optimum scope of command of the ROK Air Force Operations Command. The ROK Air Force Operations Command will be in charge of combined intelligence operations. The South and North Combat Commands will conduct commissioned operations as well as command and control sub-units and supervise their training. The Tactical Air Control Group will be replaced with the Tactical Air Control Wing in order to improve its ability to support army and naval operations.

# Section 3

## Improving the Force Structure

The Ministry is building advanced military capabilities capable of ensuring deterrence and victory in cases of an all-out war as well as coping with the threat of local provocations by North Korea by making efficient use of the available defensive resources. To achieve the goals, early warning and surveillance systems, the C4I system, which enables network-centric warfare, and a mobile strike capability will be obtained.

### 1. Directions of Force Structure Development

The MND will establish a sophisticated force system based on information and knowledge, which will guarantee victory in war, and secure weaponry and equipment with high combat efficiency. This will be achieved in the following ways.

First, following a reevaluation of the priority of the threat, it will develop a force structure composed of forces to combat local provocations, those to serve in an all-out war and forces to combat potential threats by order.

Second, it will enhance its early warning capabilities and real time battlefield surveillance and reconnaissance capabilities not only on the Korean Peninsula but also in the surrounding areas.

Third, it will boost its network-centric warfare capabilities by establishing a command, control, communications, computer & intelligence (C4I) system and battlefield network in order to secure the capacity for integrated combat.



Fourth, it will improve its ability to execute long-range precision strikes and prompt three dimensional operations on land, at sea, and in the air and reinforce its defensive capability.

Fifth, it will gradually expand investment in research and development to shape the defense industry into an economic growth engine, mount various types of equipment on the same vehicle and lengthen the lifespan of old equipment by improving its performance.

## 2. Strengthening Combat Capabilities

**| 2010 Force Improvement Program |** The entire defense budget for 2010 is increased by 3.6% to KRW 29.5627 trillion from 2009. The force improvement budget is increased by 5.7% to KRW 9.103 trillion from 2009. The cost of the major projects (184 projects) that will continue into 2010 is KRW 9.026 trillion. The budget for new projects (25 projects) is KRW 77 billion. As part of the follow-up measures to the attack on the ROK Ship Cheonan, an additional KRW 14 billion was earmarked for four projects, including an underwater surveillance sonar project. The major combat capability reinforcement projects are shown in Table 6-1.

Table 6-1. Major Force Improvement Projects (as of 2010)

Classification	Continuing projects	New projects
Surveillance, Reconnaissance, Command and Control Capabilities	-Airborne Warning and Control System -Ground Tactical C4I System	-Harbor Surveillance System -Mobile Underwater Surveillance Sonar
Maneuver and Fire Capabilities	-K21 Infantry Fighting Vehicles -K-9 Self-propelled artillery	-Korean Utility Helicopter -Improving the performance of K-55 Self-propelled artillery
Marine and Landing Capabilities	-Kwanggaeto the Great III class destroyer (Aegis) -Jangbogo II class submarine	-The 2 <sup>nd</sup> Minesweeper Project -Next-generation mine laying ship
Air Combat Capabilities	-F-15K Fighter -Advanced Trainer (T-50)	-Improving the performance of the C-130H
Research and Development	Intermediate-altitude unmanned aerial vehicle, division-level UAVs	



K-21 infantry fighting vehicles



K-9 self-propelled artillery



Kwanggaeto the Great III class destroyer



Jangbogo II class submarine



Advanced trainer (T-50)

**Mid-term Force Improvement Plan** | The MND will pursue a total of 293 force improvement projects from 2011 to 2015. It continues its 183 existing projects, including the K-2 tank project, next-generation landing ship project and F-15 project (2<sup>nd</sup> project), and sets about 110 new projects, including the Battalion Battle Command System, personnel landing craft project (2<sup>nd</sup> project) and the Boramae project. The objectives of these projects are shown in Figure 6-7.

Figure 6-7. Force Buildup Programs

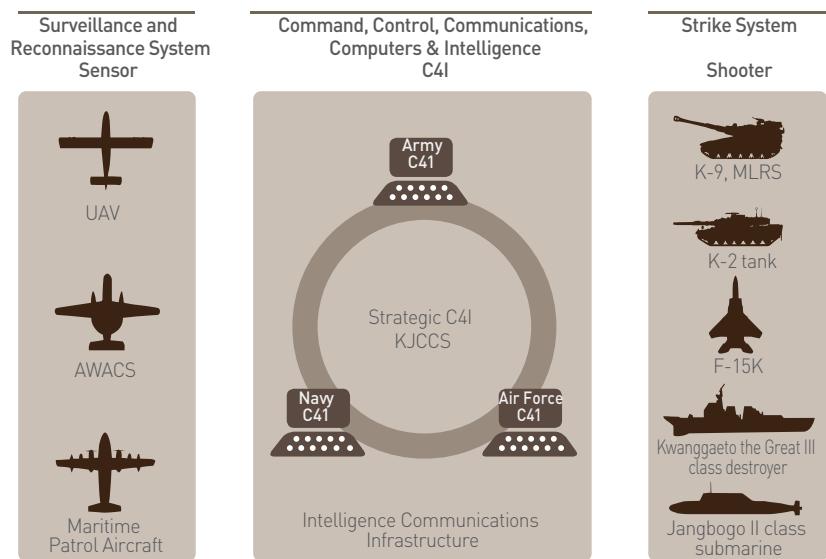

Airborne Warning and Control System (AWACS): early warning, aerial control and real time intelligence dissemination is possible across the entire Korean Peninsula.

First, the MND will upgrade the sonar equipment on patrol combat corvettes (PCC) and frigates in order to detect encroaching enemy submarines and install sonar sensors suitable for long-range detection. It will also field improved TOD, monocular night vision devices, day and night scopes or sights for personal weaponry and machine guns in preparation for enemy infiltration by land.

Second, surveillance and reconnaissance assets will target the capacity to obtain early warnings, to conduct real time surveillance on and around the Korean Peninsula, and establish real time battlefield surveillance that will meet the strategic requirements of each echelon within individual units.

Projects related to the airborne warning and control system (AWACS), tactical reconnaissance intelligence collection system and medium-altitude unmanned aerial vehicles will be carried out to enable surveillance and early warning at the strategic level. In addition, division-level UAVs will be developed to bolster the surveillance and reconnaissance capabilities of the divisions.

Third, the Command, Control and Communication System is aimed at supporting jointness and the smooth operation of network-centric warfare. The Joint Tactical Data Link System (JTDLs)<sup>1</sup> and Theater level Joint Fire Operation System (JFOS-K)<sup>2</sup> will be developed to ensure the distribution of digitized tactical intelligence in joint operations. The Ground Tactical C4I System will undergo a second round of improvements. Also, the Battle Command System for battalions or lower level units and Ground Tactical Data Link will be developed to ensure real-time distribution of real-time tactical intelligence to small units. The Tactical Communication System will utilize the Tactical Intelligence Communication Network (TICN),<sup>3</sup> which will allow for the distribution of large volumes of multimedia information.

Fourth, long-range precision strikes and three dimensional air-sea-land rapid mobility will be improved, and war capabilities to reinforce protection will be secured as well. In terms of ground forces, the K-9 self-propelled artillery, large-caliber MLRS, K-21 infantry fighting vehicles, K-11 assault rifle & grenade launcher, K-2 tank and anti-artillery detection radar will be fielded. New wheeled combat vehicles and upgraded MLRS programs will be developed. In terms of maritime power, next generation frigate (FFX), next generation patrol craft (PKX), next generation landing ship and an amphibious assault vehicle will be secured. A Kwanggaeto the Great III class destroyer (Aegis combat system), Jangbogo II class submarine (1,800 tons), and ship-to-ship guided missiles will be acquired. Landing platform helicopter and landing ships fast (LSFs) will be additionally obtained.

In terms of aerial combat capabilities, air-to-ground missiles, the F-15K (2<sup>nd</sup> phase), Korean Utility Helicopter (Surion), transport aircraft, and light attack aircraft (FA-50) projects will be continued. New projects for a heavy attack helicopter and the Korean attack helicopter, and the Boramae

### 1. Joint Tactical Data Link System (JTDLs)

A tactical information distribution system between the Army, Navy and Air Force, which employs major weapons systems, including tanks, helicopters, destroyers and fighters.

### 2. Joint Fire Operation System-Korea (JFOS-K)

A counter fire operational system centering on the Joint Chiefs of Staff.

### 3. Tactical Information Communication Network (TICN)

A tactical intelligence communications system that combines wired and wireless mobile communications.



### K-11 Assault Rifle & Grenade Launcher

- Capable of precision strikes with the use of a laser distance measurer.
- Capable of precise aiming at night with the use of a thermal observation scope.



Korean Utility Helicopter (Surion)

project will be launched. Short range anti-air guided missiles, next surface to air missile (SAM-X), and a newly developed decontamination vehicle will commence service in order to reinforce the nation's protection against chemical, biological, radioactive and nuclear threats.



Counter-battery Detection Radar: a system that locates enemy launchers by detecting enemy shells whilst in flight.

Fifth, outdated and obsolete combat weaponry will be upgraded. The Army will improve its K-1/K1A1 Tanks, K-200 Armored Vehicles, and K-277 Armored Command Vehicles, K-55 Self-propelled Artillery, and counter-battery detection radars. The Navy will improve the submarine warfare capabilities of its surface combatants (beyond the patrol combat corvette (PCC) level). And the Air Force will improve the war capabilities of its F-16 and KF-16 fighters.

# Building Up Strong Reserve Forces

The reserve forces and standing forces, which act to as a deterrent to war, are a prerequisite for any nation's survival. The Ministry is modifying the laws and institutions concerned and improving the mobilization system in order to streamline the reserve forces and have them become just as strong as the standing forces.

## 1. Modifying the Statutes Related to Mobilization

The statutes related to mobilization encompass the Emergency Resources Management Act governing the establishment of peace time emergency response plans, the mobilized resources survey and training drills, the Military Service Act governing personnel mobilization and training, and the Bill on Wartime Resources Mobilization governing the mobilization, control and operation of personnel and material resources during a war. The Bill on Wartime Resources Mobilization is a Wartime Standing Act that can be declared by the deliberation and resolution of the National Assembly or by Presidential Emergency Order if the convening of the National Assembly is infeasible. As the mobilization of human and material resources can become protracted during war, the bill is limited to times of peace only. Efforts to modify the bill are under way in consultation with the Ministry of Public Administration and Safety and the Ministry of Government Legislation. The modifications would allow the nation to cope with any national emergency that might arise during peace time through the mobilizing of human and material resources for a limited duration and scale. In addition, the nation's

ability to respond to security threats would be enhanced in times of enemy military provocations or terror attacks during peace and times of war.

## **2. Initial Operational Response and the Establishment of the Mobilization Support System for Stabilization Operations.**

The Ministry of National Defense is modifying the Mobilization Support System for the Stabilization Operational Units<sup>1</sup> in the aftermath of the expansion of the operational areas, the establishment and enlargement of Mobilized Reserve Divisions and Precision Replenishment Battalions<sup>2</sup> required to conduct initial operations.

Mobilized Reserve Divisions and Precision Replenishment Battalions are responsible for augmenting the frontline units during the initial phase of operations. So far, Mobilized Reserve Divisions have been established and augmented to support frontline units. In 2010, the Precision Replenishment Battalions replaced the Mobilized Reserve Divisions. As wartime operational areas are extended to cover the entire North Korean region, the MND has begun to upgrade the Mobilization Support System to ensure better execution of wartime operations of stabilization operation units and rear-area units of Homeland Reserve Divisions. The former is engaged in civil-military operations, while the latter is responsible for security in rear areas.

## **3. Managing Mobilized Resources and Improving the Execution System**

**| The Mobilization of Troops and Materials |** The MND is improving the mobilization of Reserve Divisions and Precision Replenishment Battalions in consideration of the mobilization designation ratio,<sup>3</sup> mobilization designation method and designation priorities pertaining to the future mobilization requirements that may result from military force restructuring. It is also anticipating the scope of the resources that could be mobilized through simulations at each Regional Military Manpower Administration.

### **1. Stabilization Operations Unit**

The unit responsible for stabilizing the operational zones in the face of military or non-military threats to national security during peace or war times.

### **2. Precision Replenishment Battalions**

The units responsible for mobilizing and forming troops, from the Homeland Reserve Divisions, in to battalions in the event that the frontline divisions or corps were to suffer heavy casualties.

### **3. Mobilization Designation Ratio**

The ratio of personnel and material resources designated according to the requirements of wartime mobilization

The MND is revising the Personnel Mobilization System so that mobilized troops can be put into operation immediately. So far, troops have been mobilized to units in the vicinity of their residences or to other designated units. Under the new system, troops will be mobilized to the units they used to serve in when they were active in the military. The Mobilization Designation Ratio of suitable MOS holders and reserve forces – for those who have been reservists for four or less years – will be increased by expanding the designated areas to include the entire nation. In addition, the scope of similar specialties will be expanded.

Measures are being studied to strengthen the verification of the suitability of the requirements to effect mobilization and to make efficient use of quality resources in the private sector to boost the mobilization efforts. Corporations with excellent production rates, or new products or new technology, will be designated for mobilization. Designated enterprises for mobilization will go through training to adjust mobilization and to improve their production rates. Future mobilization in the civilian sector will occur to allow for the simultaneous mobilization of personnel and materials.

**| Defense mobilization information system |** The MND is gradually developing the Defense Mobilization Information System. The first phase of system development, concerning the management and training of reserve forces, was completed in June 2006. This resulted in a more efficient reserve forces by establishing the Daily Resource Settlement System and the computerized training system for the reserve forces in conjunction with the Office of Military Manpower Administration. The first phase also laid the foundation for establishing a battalion level training and management system. The second phase of the system, which completed in August 2008, helped simplify the relevant administrative work, such as determining the mobilization requirements, verifying the available resources, coordinating and consulting, reporting the outcome of mobilization, and designating and managing elite personnel.

The third phase of system development, which involves the mobilization of materials since November 2009, is to establish a nationwide mobilization management system in conjunction with the agencies concerned. Such a

system would support the Emergency Information System of the Ministry of Public Administration and Safety. By 2011, the foundation will be established on which national resources can be managed efficiently and mobilized at short notice.

#### 4. Managing the Reserve Forces and Establishing an Operational System

**Organization and resource management** | The reserve forces are classified as the Mobilized Reserve Force and Homeland Defense Reserve Force depending on the mission. The Mobilized Reserve Force is composed of reserve force personnel that are discharged from active duty within four years. They function as augmenters to reinforce active units in cases when units are first established, augmented, or lost. The Homeland Defense Reserve Force is composed of reserve forces that are discharged from active duty from five to eight years. It conducts homeland defense operations in the respective areas of responsibility (AOR).

Retired officers, warrant officers, and non-commissioned officers are obliged to attend reserve forces training they reach the retirement age,<sup>4</sup> and eight years for enlisted service members as stipulated in the Military Personnel Management Act.

Male and female Korean citizens aged 18 or above can volunteer to serve in the reserve forces. About 10,000 volunteers, including women, as of March 2010 were enrolled as members of the Homeland Defense Reserve Forces. The size of the reserve forces stood at 2.93 million as of March 2010 and are composed of reserve forces at the *Eup*, *Myeon* and *Dong* regional level and reserve forces in workplaces. The status of the reserve forces is shown in Table 6-2.

Table 6-2. Status of the Reserve Forces (As of March 2010)

Unit: 10 thousand

Years passed following discharge from active duty			Composition		
Within one to four years following discharge from active duty	Within five to eight years following discharge from active duty	Total	Reserve forces at regional level	Reserve forces in the workplace	Total
132	161	293	225	68	293



The Establishment Ceremony of the 50<sup>th</sup> Division Reserve Forces (Daegu, Dec. 2009)

#### 4. Retirement Age

The retirement ages of active duty personnel by rank: Sergeant First Class (E7) 45, Master Sergeant (E9) 53, Major 45, Lieutenant Colonel 53, Colonel 56.



**| Establishing reserve forces management organization |** As part of military restructuring, the Mobilization Support Group, Homeland Defense Reserve Battalion, and Reserve Force Education and Training Group will be established to manage the reserve forces more efficiently. The Mobilization Support Group, which will be established in each Homeland Reserve Division, will manage the resources, equipment and materials related to the precision replenishment battalion, conduct mobilization training during peace time, provide support for establishing the Replacement BN and augment the frontline forces in wartime. As of 2010, the Mobilization Support Group was established in three divisions. A total of eleven divisions will be home to Mobilizations Support Groups by 2020.

The Homeland Defense Reserve Battalion will start being established in 2014. It will replace the Resources Management Battalion, which is composed of active duty personnel in each city-gun-gu level local government, under the command of Homeland Reserve Division. The Homeland Defense Reserve Battalion is to conduct homeland defense and regional stability operations, during war and peace times, such as in areas relating to the organization and management of reserve forces, command and control of regional reserve forces, and preparation against terror attacks and natural disasters. The Reserve Force Education and Training Group will train the reserve forces after the consolidation of some 200 training centers to 46 advanced Reserve Force Education and Training Centers starting in 2014. The facilities of the Reserve Force Education and Training Group will become user-friendly public places, taking the form of public parks, sports facilities, experience learning centers, and security educational centers.

**| Implementation of a Cadre Reservist Service System |** The MND has laid the foundation for recruiting managers to oversee the management of the Reserve Forces Center by revising the regulations pertaining to the recruitment of reserve forces managers.<sup>5</sup> The recruitment and management of reservist officers was also determined by modifying the Cadre Reservist Service System.

Management of the reserve forces will entail recruiting military civilians on a contract basis to work for the Mobilization Support Group, Homeland Defense Reserve Battalion or Reserve Force Education and Training



The Establishment Ceremony of the 32<sup>nd</sup> Division Mobilization Support Group (Yeongi-Gun, Chungnam province, Oct. 2009)

**5. Major points of the regulations pertaining to the recruitment of managers for the reserve forces**

- Qualifications required to apply for each commanding officer position and reason for disqualification
- Organizations in charge of administering recruitment exams and outlining the exam procedures
- Recruitment exam subjects and evaluative standards
- Management of the Committee for Screening and Review of Reserve Force Unit Commanding Officers

Group from July 2010. The status of the military civilians involved in the management of the reserve forces is shown in Table 6-3.

Table 6-3. The Status of Military Civilians Involved in the Management of the Reserve Forces (As of July 2010)

Unit: person

Classification	Regional company commander	Mobilization support group	Administrator
Army	3,602	64	360
Navy	138	-	-
Total	3,740	64	360

**| Modernizing the reserve forces' weaponry and securing combat gear |** The Ministry is planning to replace obsolete individual firearms and crew-served weapons of reserve forces with newer equipment. Old individual firearms will be replaced with the M16A1 in line with the Individual Firearm Replacement Plan for active units. Old crew-served weapons will also be gradually replaced.

50 percent of the combat gear for homeland defense will be secured by 2012, 70 percent by 2015, and 100 percent by 2020. Essential items for combat and survival, such as bulletproof helmets and gas masks, will be secured by acquiring active service supplies or drawing on the defense budget and the budget for cultivating and supporting the reserve forces.

## 5. Reserve Force Educational and Training System and Its Improvement

Most of the reserve forces undergo reserve force education and training to become fully prepared for wartime mobilization and capable of conducting homeland defense operations. Reserve Force Education and Training is classified as mobilization training, supplementary mobilization reserve training and homeland defense training. The training schedule by type and hour is shown in Table 6-4.

Table 6-4. Training Schedule by the Type (of Recipient) (as of 2010)

Classification		Mobilization training	Supplementary mobilization reserve training	Basic training for homeland defense	Training under homeland defense operational plans	Roll call	
Ex-enlisted soldiers	1 <sup>st</sup> to 4 <sup>th</sup>	Designated for mobilization	Two nights and three days	-	-	-	
		Non-designated members for mobilization	-	24 hours	-	12 hours	
	5 <sup>th</sup> to 6 <sup>th</sup>	Designated for mobilization	-	-	8 hours	6 hours	4 hours
		Non-designated members for mobilization			8 hours	12 hours	
	7 <sup>th</sup> to 8 <sup>th</sup>		Organized without training				
Ex-officers	1 <sup>st</sup> to 6 <sup>th</sup>	Designated for mobilization	Two nights and three days	-	-	-	
		Non-designated members for mobilization		Two nights and three days			
	7 <sup>th</sup> to 8 <sup>th</sup>		Organized without training				
Volunteers					6 hours		



Mobilization training (infantry-tank combined arms training)



Mobilization training (artillery fire training)

**Training system and its improvement** | The MND is improving the reserve forces educational and training system to make its programs more accessible to individuals and to yield greater results. Supplementary mobilization reserve training and homeland defense training are conducted using survival game equipment to mimic real combat situations at the reserve force educational and training centers. A measurement-based passing system has been introduced to instill motivation.

A weekend reserve training institution has been introduced to help self-employed businessmen and college students. Optional training schedules offered online enable reservists to undergo training at their convenience. The National Reserve Force Training System allows reservists to receive training at a location of their choice. The training schedule, including the weekend schedule, is shown in Table 6-5.

Table 6-5. Training Schedule, including the Weekend Schedule

Unit: person (%)

Classification	Total number of trainees	Weekend training	National reserve force training system
2007	1,616,808	12,070 (0.75)	-
2008	1,604,529	15,240 (0.95)	21,843 (1.36)
2009	1,561,259	15,561 (1.00)	71,789 (4.60)

The MND is making progress in improving food rationing and transportation and training facilities associated with the education and training of the reserve forces. To this end, the MND is working on the following: the expansion of dining provided by the training units, stricter monitoring of the safety and hygienic standards for lunch box suppliers, extension of public transportation routes, expansion of the shuttle bus service to and from the training units, and installation of more fermentation-based latrines.

**| Directions of reserve forces training and educational development |**

It is necessary to keep the reserve forces strong by extending their educational and training hours to make up the falling number of standing forces and shortening of the service period of active duty personnel. The MND is planning to gradually extend the training hours to the extent that training activities do not discomfort the public.

As of 2010, reserve force education and training is composed of mobilization, supplementary mobilization, roll call, basic training for homeland defense and training under the Homeland Defense Operational Plans. From 2016, these five areas of training will be condensed into two areas: mobilization and homeland defense training with a focus on preparation for war.

Part of the training program, including security education, will be available online and conveniently accessible from home. Voluntary training will also be encouraged. The training schedule and its hourly increases by year are shown in Table 6-6.

Table 6-6. Scheduled Hourly Increases by Year to the Reserved Forces Training Schedule

-No training for members of the reserve forces who have been discharged from active duty for seven or more years

Classification	2009-2010	2011-2015	2016-2019	After 2020
Mobilization training	Two nights and three days		Three nights and four days	Four nights and five days
Homeland defense training	20-36 hours	20-36 hours (including a two hour online educational session from 2012)	36 hours (including a four hour online educational session)	

The compensation for reserve forces education and training will be increased over the short term to meet the real cost of participation. Over the long haul, the compensation will be increased to the minimum wage level. The trend in compensation by year is shown in Table 6-7.

Table 6-7. Cost of Supplementary Mobilization Reserve Training and Basic Training for Homeland Defense (Transportation + lunch/per day)

Unit: Won

Classification	2007	2008	2009	2010
Sum	5,300	6,000	7,000	9,000

# Section 5

## Establishing a Network-Centric Defense Informatization Environment

Defense informatization seeks to establish the network-centric operational environment that is required in the future battlefield. The Ministry of National Defense (MND) has been establishing battlefield management by information superiority and efficient defense management as well as ubiquitous information communications infrastructure that allows on-demand information to be accessed at anytime and anyplace through defense informatization. The MND is improving the informatization promotion framework based on the Defense Informatization Act to advance its informatization environment and reinforcing its information security systems to more effectively cope with transnational cyber threats.

### 1. Defense Information Resource

Defense information and ancillary resources required for defense informatization such as equipment, technology, manpower, budget and so forth

### 2. Major points of the Act of Foundation for Defense Informatization and Defense Information Resource Management

- Establishing the strategic plan, enterprise architecture, and integrated decision making system
- Timely adoption of new IT technology to national defense and appointing organizations to take exclusive charge of informatization
- Enhancement of interoperability, reinforcement of standardization, and strengthened protection of information security
- Acquiring and systematically managing defense information resources
- Establishing project management strategy and procedure for defense informatization in consideration of IT technology characteristics
- Improving the evaluation system to enhance transparency and boost the effect of policies and projects

\*Effective on 1<sup>st</sup> Jan. 2011. Composition: Preamble, 7 chapters, 28 articles and 2 riders.

### 1. Defense Informatization Promotion Framework

**| Defense Informatization Act established |** The Act Regarding the Foundation for Defense Informatization and Defense Information Resource<sup>1</sup> Management was established on February 4, 2010 to pursue defense informatization, a core locomotive for building military capability and an efficient means of national defense management.

The Defense Informatization Act<sup>2</sup> has reflected the changes in the defense informatization environment and the characteristics of information technology. The MND will develop defense informatization system according to the Defense Informatization Act by integrating weapons systems and non-weapons systems, which have been developed separately

The Defense Informatization Act is expected to bring about the timely establishment of a network-centric defense information systems. These systems would be capable of collecting advanced defense information

technology, managing defense information resources systematically, developing defense informatization in tandem with the national drive for informatization, and acquiring the resources necessary to pursue defense informatization.

**| Developing defense informatization governance |** The MND established and has been developing Defense Informatization Governance<sup>3</sup> in consideration of the military characteristics and the developmental trends in information technology. Defense Informatization Governance incorporates related institutions and organizations together with the management, operation and maintenance of information systems and is specified in the Defense Information Service Act and directives or orders of the MND.

The vision of the MND is network-centric knowledge-based defense informatization to promote the development of goal-oriented defense informatization. The master plan for the comprehensive development and implementation of such a system has already been established to realize the vision. The master plan for the defense informatization is composed of the Defense Informatization Policies and the Strategic Plan for Defense Informatization and the Integrated Enterprise Architecture.<sup>4</sup> The Defense Informatization Policies, published in 2009, set the policy directions for defense informatization and encompass the long- to mid-term development plans. The Strategic Plan for Defense Informatization and the Integrated Enterprise Architecture was established at the end of 2010.

The defense informatization policy is aimed at integrated and goal-oriented informatization, information sharing based on interoperability, improving the effectiveness of information systems and promoting cooperation between civilians, the government and the military. What will result is a network centric operational environment that allows information to be shared and utilized in real-time. A strategy has been mapped out to advance the ‘Information Services, Infra and Informatization Promotion Framework’ that is provided through defense information systems. The defense information systems are shown in Table 6-8. The systems are composed of advancement in five areas,<sup>5</sup> the implementation of four

### **3. Defense Informatization Governance**

A formalized system to govern the establishment of an informatization strategy and plan that matches the vision and objectives of national defense. The decision making mechanism, institutions involved and procedures are based on participation and communication.

### **4. Integrated Enterprise Architecture**

A comprehensive design that contains the structure and interrelations of the system components, its current status, future objectives and implementation plans to achieve the set goals.

### **5. Five Areas where the defense information systems are to be advanced**

Infrastructures, Applications, Modeling and Simulation, Interoperability and Standardization, Information Assurance

**6. Four Initiatives**

- Providing the legal basis for pursuing defense informatization
- Establishing the blueprint for informatization
- Establishing an integrated information management system
- Expanding soft infraware

**7. Three Management Systems**

Information Resources Management, Informatization Performance Management, and Information Communications Service Management

**8. Modeling & Simulation (M&S)**

Simulation of natural phenomena by utilizing computers.

initiatives<sup>6</sup> to boost informatization and advancements in three management systems<sup>7</sup> to boost management and operational efficiency

Table 6-8. Structure of the Defense Information System

Classification		Major system
Battlefield Management Information Systems	Command and Control Systems	Joint Strategic C4I Systems (KJCCS)
		Combined C4I Systems (AKJCCS)
		Tactical C4I Systems (ATCIS, KNCCS, AFCCS)
	Military Intelligence Systems	Military Information Management System (MIMS)
	Combat Command Systems	Combat Command Systems (BTCS, KNTDS, MCRC)
Business Management Information Systems	Planning and Financing Information Systems	Integrated Defense Financial Information System and Others
	Information System for Logistics and Facilities	Logistics Information System and Facilities Information System and Others
	Information System for Personnel and Mobilization	Personnel Information System and Mobilization Information System and Others
	Information System for Electronic Administration	Onnara System and Archives Management System and Others
Infrastructure		Satellite Communication Networks and Broadband Convergence Network Tactical Communication Networks, Hardware, such as Servers and PCs, and Encryption Equipment and Others
Modeling and Simulation Systems		War Game Models, Analysis and Acquisition M&S <sup>8</sup> Models and Others.

**| Establishing the integrated architecture for the defense information systems** | The MND is establishing enterprise architecture for the defense information systems to systematically maintain information resource management and ensure interoperability between information systems. As shown in figure 6-8, the Defense Information System Architecture includes battlefield management, business management, and joint war games. The Integrated Defense Information System Architecture presents the systems currently being operated, the future objectives of the system, and the transition plans to achieve the objectives in a standardized manner that can be easily understood by all users.



Figure 6-8. Plan to Establish the Integrated Defense System Architecture

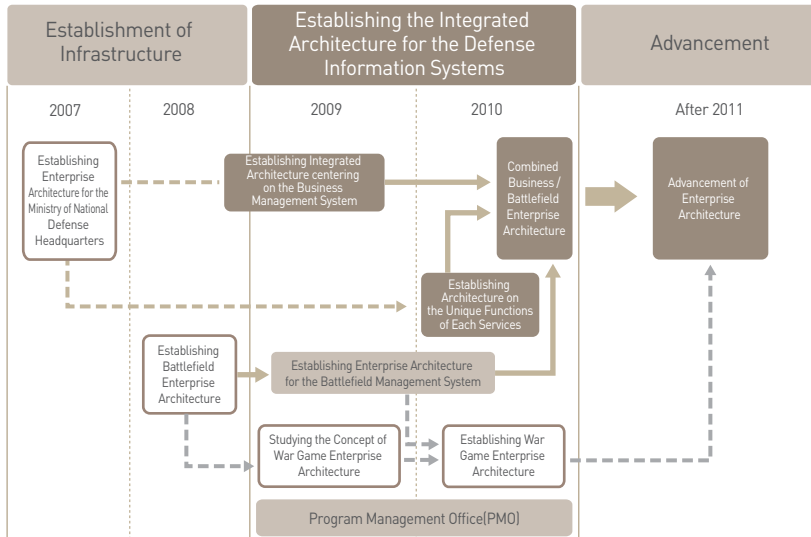

The Business Management Information System Architecture was established and is supervised by the MND on information systems for the consolidated defense business management and the unique functions of each Service. The Battlefield Management Information System Architecture was established and is supervised by the Joint Chiefs of Staff. It was integrated with the Business Management Information System Architecture to form the Integrated Defense Information System Architecture in 2010.

In modeling and simulation area, war game enterprise architecture is being established mostly for exercise and training models and will be incorporated in the integrated architecture for information systems. The integrated architecture for the Defense Information Systems will be further developed and refined from the viewpoint of national defense comprehensively from 2011. It will provide the blueprint for future defense informatization.

The MND carries out Program Management Office to guarantee professional project management and product quality in order to pursue successful implementation of The Integrated Defense Information System Architecture. Integrated Architecture for the Defense Information contributes to determining the requirements of the Defense Information Systems and improving its

### 9. MND-ARMS (Architecture Repository Management System)

A system that efficiently uses and manages architectural products.

### 10. Virtualization

Technology that logically combines or divides systems with different physical characteristics, such as hardware and software, to ensure the efficient use of information resources.

### 11. Broadband convergence network bandwidth

10Gbps for the operational command level and beyond, 2.5 Gbps for the corps level, 622Mbps for the division level, and 155Mbps for the regiment level and below.

### 12. IP (Internet Protocol)

International standard data communications protocol. It is the standard for Internet use.

performance. The Defense Enterprise Architecture utilizes MND-ARMS<sup>9</sup> as a comprehensive tool to manage its products.

## 2. Advancement of the Defense Information System and Guaranteeing Its Interoperability

**Information communications service and infrastructure improvements** | The MND is seeking to create a user-oriented Defense Information Systems and to improve the system's infrastructure through the use of virtualization technology.<sup>10</sup>

For these purposes, the MND will seek the investment of the private sector to establish a broadband convergence network for national defense by the end of 2010. The broadband convergence network will lay the groundwork for fixed and mobile convergence network by providing up to 10 Gbps bandwidth<sup>11</sup> to each echelon of individual units. As a result, the strategic and tactical networks, including ground and aerial/satellite communications networks, will be standardized as an IP<sup>12</sup> and develop into an integrated wired and wireless network. The composition of the Defense Information and Communications Network is shown in Figure 6-9.

Figure 6-9. Composition of the Defense Information and Communications Network

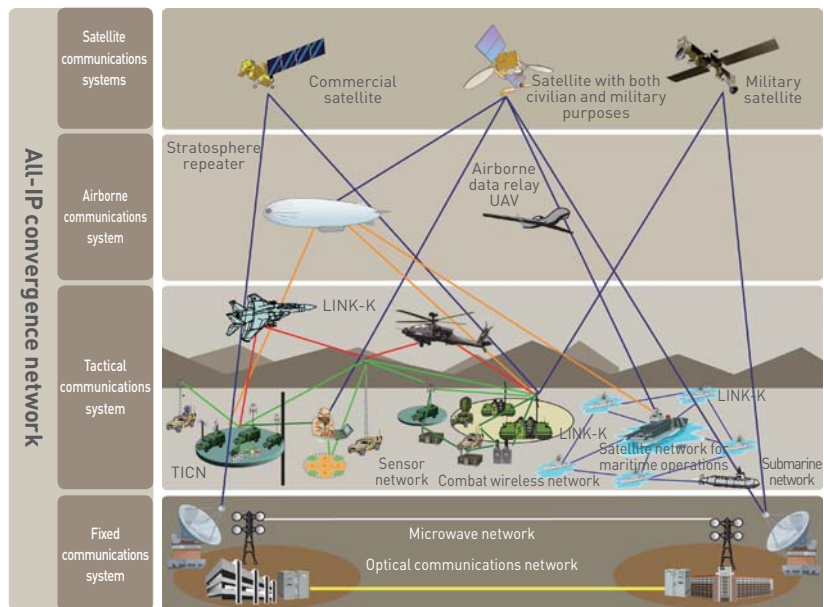

An indigenously developed WiBro<sup>13</sup> Communication Network was established in an Air Base for demonstrative purposes, and has expanded into another Services. The defense IPTV network's 30,000 or so circuits were in operation in the barracks as of 2010 to provide various cultural contents to service members and make distance learning possible.

The MND will consolidate currently operational computing centers in each level of the services and units into two Consolidated Defense Information services can be easily accessed. The Consolidated Defense Information Data Center, a data center serving as an infrastructural environment, will be equipped with virtualization technology to accommodate various applications composed of various software and hardware devices, such as servers and storage devices.

In addition, and in line with the eco-friendly green growth policy of the government, green IT technology will be applied to the power and heat management system of the Consolidated Defense Information Data Center in order to reduce energy consumption.

**| Strengthening the interoperability of the defense information systems** | The Defense Information Systems have to undergo interoperability verification and evaluation at every major stage from the proposal of requirements to deployment. The MND will develop the relevant interoperability policies and institution. The Joint Interoperability Technology Center of the Defense Command/Communications Command evaluates and certifies interoperability.

In 2010, the Joint Interoperability Technology Center established a Test Facility, which reinforced its evaluation methods according to the characteristics of objective systems and improved levels of interoperability, including the Level of Information System Interoperability (LISI) Assessment.<sup>14</sup> It is also upgrading the functionality of the Defense Interoperability Portal (DIPS)<sup>15</sup> established in 2008.

The interoperability-based technology to be utilized by the Defense Information System is being developed based on the Common Operating

### 13. WiBro (Wireless Broadband)

Locally developed mobile wireless data communications technology developed in Korea that makes Internet use and voice calls possible.

### 14. Levels of Information System Interoperability (LISI)

A procedure that evaluates a specific information system or the interoperability level between systems to determine the performance of the system.

### 15. Defense Interoperability Portal System (DIPS)

A portal system that oversees the introduction, testing and evaluation of defense interoperability businesses.

#### **16. Common Operating Environment (COE)**

An environment in which existing software is recycled to reduce the developmental period for an information system and to improve its interoperability.

#### **17. Shared Data Environment (SHADE)**

An environment that allows for the standardization of commonly used data so as to improve interoperability.

#### **18. Defense Information Technical Standard (DITS)**

A system that standardizes by type and method the classification of the information technology related to defense.

#### **19. Computer Emergency Response Team (CERT)**

An organization that prevents or responds immediately to computer and network-based attacks. It is equipped with an information security integrated control system.

Environment (COE)<sup>16</sup> and Shared Data Environment (SHADE).<sup>17</sup> The Common Operating Environment (COE) improves interoperability and shortens developmental periods by registering the major functions as components that are shared in the Defense Information Systems and recycling them. The Defense Component Management System was overhauled and the list of components modified in 2009 to allow for the systematic registration and addition of new components.

With regard to the data sharing environment, the data used for battlefield and business management information systems are being standardized and defense modeling and simulation data are being expanded. The Defense Information Technical Standards<sup>18</sup> for the Defense Information Systems and Technical Standardization were revised across the board in 2009 and are now accessible on the Internet. The Defense Information Technical Standards is established in line with the international and national standards and revised twice a year in order that new technologies can be applied to the defense sector.

### **3. Strengthening the Capability to Respond to Cyber Threats**

**| Advancing the information protection system and securing cyber response technology** | The Ministry of National Defense is strengthening its information assurance systems to guarantee mission completeness of military operations during times of peace and war, against cyber threats, which have been becoming increasingly intelligent and virulent. The MND revised the Directive on Information Assurance in 2009 to establish an information assurance system and systematically manage the response process in preparation for cyber threats. Computer Emergency Response Teams (CERT)<sup>19</sup> have been established at the corps level and oversee the Defense Information Systems 24 hours a day, and are on constant alert for threats.

The MND is redefining missions of each agency for information assurance and has established a Cyber Warfare Response Center in accordance with the establishment of the Cyber Command.

Every computers connected to the Defense Information Network have

equipped with virus immunization systems, detection and preventing systems for hacking attempts and hacking mail protection systems to minimize damage from hacking and virus infections. The information communication equipment being utilized in the Battlefield Management Information Systems are operated in a separate encrypted network to minimize the chances of possible attacks.

The Distributed Denial of Service (DDoS) Protection System was established in the major information systems in 2010. The right to access important data has been classified in various levels to ensure stable operation of the information sharing environment, which is protected by the Classified Data Management System. Systems to diagnose and prevent the release of personal information have been implemented to better protect of personal information.

**| Strengthening cooperation in order to respond to cyber threats** | International coordination and information exchanges are becoming increasingly important to respond to cyber threats, which have become a global issue. The MND concluded in April 2009 a Memorandum of Understanding on Information Assurance and Cooperation on Computer Network Defense with the U.S. Department of Defense. It is aimed at strengthening cooperation between the ROK and the U.S. in dealing with cyber threats.

Since 2010 the MND has been holding the ROK-US Information Assurance Working Group Meetings in accordance with the Agreement on the Composition and Operation of the ROK-US Information Assurance Working Group that was signed by both parties in November 2009. Also, since 2009, the MND has participated in the International Cyber Defense Workshop supervised by the U.S. Department of Defense twice a year to enhance its cyber warfare capability and increases bilateral cooperation on information assurance.

The MND has also bolstered its cooperation with the nation's governmental agencies by sharing information on responding to cyber threats. It has hosted seminars on the defense information assurance every year and has trained experts in information assurance.

# Chapter 7

## Improving the Cultivation, Educational and Training Systems for Defense Personnel

**Section 1.** Developing Defense Personnel Operations and Management System

**Section 2.** Realignment of the Mental Strength Education System

**Section 3.** Cultivating Strong Warriors by Concentrating Efforts on Training and Education

**Section 4.** Improving the Educational System for Officers to Boost Jointness and Efficiency

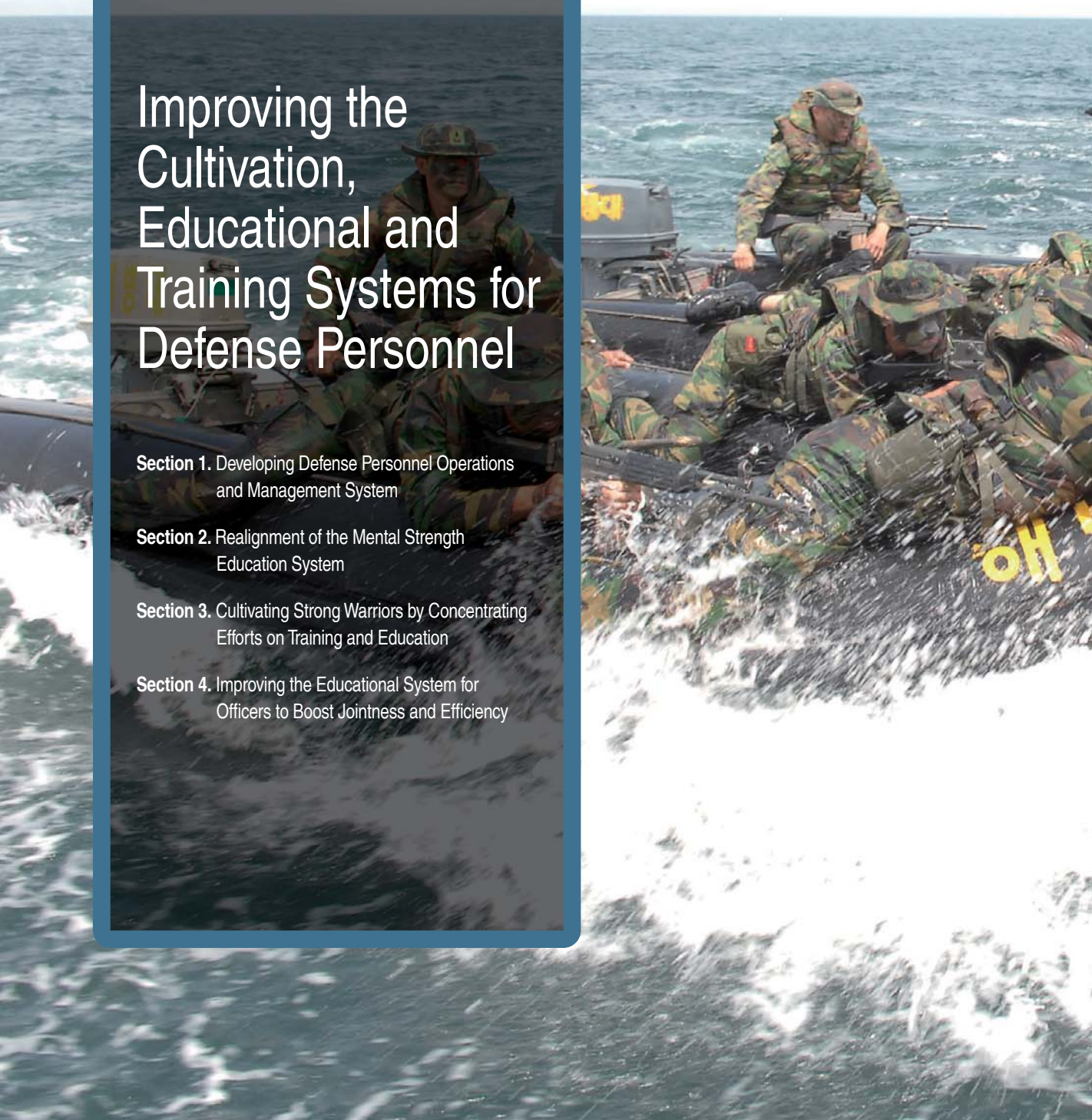



# Developing Defense Personnel Operations and Management System

The Ministry of National Defense (MND) is establishing a defense personnel procurement system and an excellent human resources procurement system in order to cope proactively with changes in the environment of securing, on a stable basis, excellent human resources who will play a major role in the battlefields. It guarantees optimized tracts for promotion to ensure job security, while maintaining a personnel structure centering on cadres and is expanding the opportunities for excellent personnel to choose military service as their career. It has also established and developed a personnel management system based on expertise building so that exemplary human resources can be selected and appointed to those positions at which they are most required.

## 1. Procuring and Managing Defense Personnel

The MND is shifting the focus of personnel structure from enlisted men to officers with the requisite expertise so as to foster a technology-intensive personnel structure. It is pursuing a policy for procuring and managing defense personnel, and placing emphasis on improving personnel structure and the personnel procurement system for officers and non-commissioned officers and on utilizing female resources.

**| Designing an optimum personnel structure |** The MND is revising the personnel structure to maintain the optimum level of service period for each rank and ensure promotion to the upper ranks, thus ensuring the job security of officers and non-commissioned officers.

The current personnel structure is the inefficient Massive Procurement, Short-term Service, and Massive Loss system: First and second lieutenants constitute a disproportionate share of the entire military structure and retire after two to three years of service, making it difficult to secure the expertise



of military officers. If the system is changed to the ‘Low Procurement and Long-term Service’ system, then expertise could be better secured. However, such a change can lead to a budget increase as the number of upper level officers increases. In addition, this increased number of high ranking officers would weaken the military structure centering on commanding officers.

Therefore, the personnel structure will be revised to ensure the optimum level of promotion within each rank and to secure job security. For instance, as for officers, the ratio of company grades will be lowered while the ratio of field grades will be raised. As for non-commissioned officers, the ratio of staff sergeants will be reduced while the ratio of sergeants first class and above will be expanded so that expertise within each rank and personnel efficiency can be fostered.

**| Improving the procurement system and recruitment methods for excellent personnel** | It is paramount to establish various procurement and educational processes in a rational manner and to secure a customized personnel procurement system to recruit excellent military officers.

First, the current various officer training courses, including the Military Academies and ROTC, are expensive and inefficient for securing excellent personnel because of the wide discrepancy between the officers from the different training courses in terms of their capabilities. The training courses will thus be combined to a reasonable degree.

Second, a plan to recruit female ROTC candidates is underway. The yearly goal for recruiting female officers candidates by the Army stands at about 200. Some portion of this quota will be procured from the ROTC. Seven colleges were chosen on a trial basis in September 2010, and sixty ROTC candidates will initially be chosen and used as the basis for determining future expansion of the ROTC for female candidates.

Third, military-related departments have been established in certain universities according to the agreement reached between the academia and

the military. This is a customized procurement system, which can reduce the cost and time associated with cultivating the required personnel, compared with procuring personnel by the military alone. Military-related departments were established in four universities from 2004 to 2009, in eight universities in 2010 and more are planned after 2015, which would result in a total of ten universities. Departments for the training of non-commissioned officers were established in 37 junior colleges in 2010 and this number will increase to 45 after 2015. The officers and non-commissioned officers produced by these universities and junior colleges are estimated to perform better than those from general departments in terms of the Officer's Basic Course (OBC) and their field mission capabilities. The agreements between the academia and the military will be expanded based on the merits of the customized personnel procurement system. The scheduled agreements between the academia and the military are shown in Table 7-1.

Table 7-1. Scheduled Agreements between Academia and the Military

Classification		2010	After 2015
Officers	Military departments	Eight universities (320 students)	Ten universities (400 students)
Non-commissioned officers	Departments for the training of non-commissioned officers	37 junior colleges (3,640 students)	45 junior colleges (4,500 students)

Fourth, the ratio of college students applying to become officers has been dwindling. The reason for this revolves partly around the uncertainty associated with becoming an officer and partly the reduction of the service period for enlisted soldiers, which induces most freshmen and sophomore students to join the military as enlisted soldiers. Hence, to solve this problem, a 'Prepared Officers Candidates' system was introduced in 2010. Under this system, a portion of the ROTC candidates and applicants for the Korea Army Academy is selected in advance as prepared officer candidates, and the final officer candidates or cadets for the Academy are then chosen after certain required procedures to become a member of the ROTC or the Academy have been undergone. Thus far, all the Officer candidates have been selected from college graduates and graduating college students. However, in the future, 30 to 70 percent of the prepared officer candidates

will be selected from college students in their freshman to junior years.

Student candidates for college graduate officers or the ROTC, who have shown outstanding performance, will be granted scholarships to secure excellent short-term serving officers.

Besides, junior cadre selection tools have been developed and applied to procure excellent junior cadre through a fair and objective selection process. The tools measure the intellectual capacity, vocational aptitudes and judgment skills of candidates. The tools are especially effective in selecting excellent junior cadres in that they measure not only the intellectual capacity but also the qualifications and capacities of individual candidates.

**| Increasing the efficiency and stability of personnel management** | Military personnel management should be conducted based on the end-strength required by each Service and rank. The personnel to be promoted and to be lost by discharge or retirement should be accurately gauged in order to fill the vacancies in a timely manner and with the optimal replacements. History shows occasional superfluity or want in some ranks.

These phenomena took place when the retirement age was extended as a result of revisions of the Military Personnel Management Law in 1989 and 1993. The retirement age was extended by one year, every three years, to 56 for colonels in 2003 and 53 for lieutenant colonels in 2006. The extension of the retirement age limit is shown in Table 7-2.

Table 7-2. Extension of the Retirement Age According to the Amended Military Personnel Management Law in 1989 and 1993

Rank	Before 1989	1989 to 1993	After 1993	Note
Colonels	50 years of age	53 years of age (+ 3 years)	56 years of age (+ 3 years)	+ 6 years
Lieutenant colonels	47 years of age	49 years of age (+ 2 years)	53 years of age (+ 4 years)	+ 6 years
Majors	43 years of age	45 years of age (+ 2 years)	45 years of age	+ 2 years
Sergeant majors	50 years of age	53 years of age (+ 3 years)	55 years of age (+ 2 years)	+ 5 years

In order to ease the problem of officers serving for excessively long periods at the same rank as a result of the extended retirement age, the minimum service period was extended for each rank and the age limit for consecutive active duty was abolished. The extension of the retirement age improved job security but exacerbated personnel oversupply due to a reduction in the cases of retirement and a certain level of promotion. Promotions were granted to prevent a possible drop in the morale of the forces due to the plummeting promotion ratio. Promotions for core personnel, such as fighter pilots, were inevitable to halt the drain of skilled personnel. As the MND has been improving personnel management since 2008, 2012 is expected to see its normalization and the removal of excess personnel.

Additionally, a quantitative personnel resources forecasting model was developed to forecast personnel resources, analyze their structure and determine their procurement requirements in order to oversee personnel management more efficiently and stably. The model has been continuously refined to be applied to overall management of personnel resources, including officers, non-commissioned officers, enlisted soldiers and military civilians, and the management of expert personnel by branch and by specialty.

**| Expanding female resources and improving service conditions** | The MND is expanding the use of female resources. In addition, it has been developing female defense personnel<sup>1</sup> policy that takes into account the mental and physical concerns of women, including the protection of their maternity rights, and raises awareness of gender equality. The number of female defense personnel stood at 10,843 as of 2010, with female soldiers numbering 6,203, female public servants 304, and female military civilians 4,336. The composition of female defense personnel is shown in Tables 7-3 and 7-4.

Table 7-3. Status of Female Soldiers

Unit: No. of soldiers

Officers				Non-commissioned officers				Total
Army	Navy	Air Force	Sub-total	Army	Navy	Air Force	Sub-total	
2,328	324	398	3,050	1,996	457	700	3,153	6,203

**1. Female Defense Personnel**  
Female public servants working at the MND, female soldiers in each Service and female military civilians.

Table 7-4. Status of Female Public Servants and Female Military Civilians

Unit: No. of persons

Female public servants				Female military civilians				Total
Level 4-5	Level 6-7	Level 8 and under	Sub-total	Level 3-5	Level 6-7	Level 8 and under	Sub-total	
44	102	158	304	173	1,245	2,918	4,336	4,640

The MND decided in October 2009, in consideration of the civilian workforce environment and the future changes to be instigated in the military's organization, to expand the end-strength of female soldiers by 2016, rather than by 2020 as specified in the National Defense Reform Act, and to adjust the expansion of the quota by a larger margin than originally planned. The scheduled expansion of the quota of female soldiers by year is shown in Tables 7-5 and 7-6.

Table 7-5. Goal to Expand the end-strength of Female Soldiers (by 2016)

Classification	Original plan	Revised upward
Female officers	5 % of the end-strength of officers	5.5%
Female NCOs	7 % of the end-strength of NCOs	7.7%

Table 7-6. Female Soldiers Expansion Target by Year

Unit: No. of persons

Classification	Army	Navy	Air Force	Total
2010	4,700	834	1,108	6,642
2016	7,224	1,725	1,603	10,552
2020	7,976	1,866	1,728	11,570

The principle behind the use of female soldiers is that they should be equally respected when appointed to positions for which they are qualified and that they will perform the same missions during peacetime and wartime as their male counterparts. Currently, female soldiers are being dispatched for diverse missions as commanding officers, staff members, combatant crew and fighter pilots. They are also playing a role in elevating national stature through overseas missions involving combined Civil Military Operation and medical support activities.



Female soldiers conducting their missions

Female soldiers, however, are prohibited from assuming positions that involve ground close combat at the battalion level or under, and from being dispatched to units engaging in special operations, or long range reconnaissance missions.

The MND is pursuing a variety of service policies to ensure that female soldiers fully realize their potential in different areas.

## **2. Gender recognition**

An ability to recognize and consider the impact of sexual (biological) differences and social and cultural gender differences on the life of men and women.

First, gender recognition<sup>2</sup> enhancement education for all service members is being reinforced at military educational centers and field units to help a culture of gender equality take root within the military. The educational curriculum is also being outsourced to specialized educational institutions. The National Defense Intranet is also being drawn on to offer cyber lectures as part of the efforts.

## **3. Counselor System for Addressing Female Grievances**

**Operation:** a total of 542 counselors (female soldiers and military civilians) at the division and brigade level and above.

**Mission:** counseling for and solving complaints, education about preventing sexual harassment and support for adapting to the units.

Second, the Counselor System for Addressing Female Grievances<sup>3</sup> is in operation to handle female service members' grievances and prevent gender-related disciplinary accidents. The rights of female soldiers are being enhanced by rectifying irrational systems and discriminatory regulations that come to attention during the grievance handling process.

Third, adequate conditions for child delivery and rearing have been provided for female soldiers who choose to seek civilian hospital care for their obstetric or gynecological needs. Subsidies for these services along with the expansion of nursery facilities in conjunction with local governments are also provided.

## **4. Assessment of impact by gender**

The possible impact of government policies on men and women is analyzed to reduce the social cost that may arise from sexual and gender discrimination.

Fourth, assessments of impact by gender<sup>4</sup> are being carried out so that major defense policies can be set up and implemented from the viewpoint of gender equality. The future impact of the defense budget on male and female soldiers is being analyzed in order to eliminate possible gender-based discriminatory practices in military bases and camps in order to prevent any form of discrimination from occurring. Policies geared toward the employment of female resources are being developed, thus helping retired female soldiers to find jobs outside the military.

## 2. Securing a Fair and Rational Personnel Management System

The MND introduced a Personnel Management System Based on Expertise in 2008. It is shifting from an emphasis on the balanced and even distribution between the commissioning sources and years, branches, and functional specialities to an emphasis on ability and expertise when it comes to promotion and personnel management. Thus, the MND will cultivate military resources that are specialists of highest caliber and capable of becoming leaders in a future battlefield. Since 2010, further efforts were made to nurture combat capabilities by taking into account the results of physical strength assessment of individuals when evaluating their performances for personnel management.

In terms of comprehensive improvement of personnel management, improvements in the management of officers based on expertise, the Comprehensive Plan for the Development of Non-Commissioned Officers, and the Personnel Management System for Military Civilians are being refined over the short term. Meanwhile, over the long term, a system for cultivating future-oriented personnel resources for the respective ranks is being studied. The content of the major improvements to be made to the respective ranks is as follows.

**| Officers** | A personnel management system for experts in jointness and acquisition has been improved to ensure the management of officers based on their professionalism and abilities. Underway is the introduction of measures to improve officers' English proficiency and the Duty Assignment Eligibility Review System.

First, the organization of the Joint Chiefs of Staff and related laws and ordinances governing it will be revised to specify the requirements and expand the number of the joint positions designated in the Joint Chiefs of Staff and joint units. The standard of qualifications for joint positions will be reestablished as well in a practical manner.

Second, ever since the Defense Acquisition Program Administration was launched with authority to independently conduct personnel management



Professional areas of officers

such problems as a lack of interoperability with field units and low level of expertise pertaining to the acquisition tasks for each Service have been exposed. In order to solve these problems, measures to improve the efficiency of personnel management will be explored. Emphasis will be placed on professionalism in the implementation of the Personnel Management System for Specialists in Acquisition.

Third, the efforts to foster English-speaking personnel and strengthen their English proficiency will be reinforced in preparation for wartime OPCON transition and to sharpen the global competitiveness of officers, who will then play a leading role in combined and joint operations. Underway are measures to evaluate English ability, which will be taken into account in the deliberation process for promotion and assignment.

Fourth, the assignment of qualified personnel to major specialized positions will ensure efficient personnel management. Therefore, the Duty Assignment Eligibility Review System will be introduced to evaluate candidates for positions in accordance with the required qualifications and optional qualifications demanded by each position to be filled. In addition, the Performance-Based Evaluation System will be developed to ensure verification of the ability and professionalism of each individual and to provide systematic training and management of personnel resources.

Fifth, just and sound promotions will be ensured by a four-tiered deliberation system to identify those personnel with ability, professionalism and morality. In addition, the ratio of term-based promotions to total promotion cases will be increased gradually so that competent personnel with outstanding records for the term of their rank will be granted promotions.

Sixth, the commanding generals of divisions and brigades have been commissioned with the authority to recommend personnel for promotion to the rank of major in an effort to strengthen the authority of field command officers over personnel affairs. Personnel serving in close contact areas are granted extra credits and given special consideration when they apply for long-term service, education or promotion. The efforts to foster an earnest service atmosphere will be enhanced by introducing systems for determining



eligibility for extension of service and for evaluating the performance of service members.

**| Non-commissioned officers |** The Comprehensive Plan for the Development of Non-Commissioned Officers has been mapped out to achieve and maintain an elite non-commissioned officer structure and to boost their morale. The plan concerns a wide spectrum of areas, including the improvement of the personnel structure, improvement of recruitment and selection, development of an educational system and improvement of career management.

First, the ratio of non-commissioned officers to the combined personnel resources of officers, non-commissioned officers, and enlisted soldiers will be increased to 26 percent by 2020, the target year for defense reform, from the current 17 percent. In line with this, the skill levels of non-commissioned officers and their job security will be ensured by decreasing the number of short-term service members and increasing the number of mid- and long-term service members.

Second, in consideration of the trend involving a reduction in the service term of enlisted soldiers and the number of eligible resources for service, applicants for short-term and long-term service will be recruited separately at the procurement stage. Cooperative agreements between the academia and the military will be continuously pursued, and the partner colleges, currently accounting for the bulk of the agreements with colleges in various regional cities, will be expanded gradually to include those located in the Greater Seoul Metropolitan Area.

Third, refresher training will be reinforced in consideration of the future force structure, weapons systems and the cooperative capabilities of the different branches. The Korea Army Training Center, Division Boot Camp Training Center, and the Non-Commissioned Officer Academy, which are responsible for cultivating specialized staff sergeants and paid volunteer short-term sergeants, will be incorporated in the Non-Commissioned Officer Academy. Quality training and education and the resulting prompt application of the new doctrines to the field will instill self-confidence in junior NCOs



Various duties of NCOs

and contribute to the combat capability of small units.

Fourth, a career management model for non-commissioned officers will be developed that requires them to serve in specified positions and branches in order to help them manage their careers systematically and boost their individual capacities.

Fifth, in line with the honorary promotion of officers, a system of promoting master sergeants, who have served honorably for at least 20 years, by one rank to sergeant major, on the date of discharge, will be pursued to boost the morale of non-commissioned officers.

The Comprehensive Plan for the Development of Non-Commissioned Officers will be pursued in earnest to reshape the role of non-commissioned officers who are well trained for a future science and technology force.



Maintenance activities of military civilians

**| Military civilians |** The restructuring of the management of military civilians and comprehensive implementation initiatives have been established to bolster the expertise of military civilians and encourage their continued service. To secure excellent personnel, the recruitment system has been improved; the exam questions, which used to be prepared by both active duty personnel and college professors, are now prepared solely by college professors and the number of subjects covered in the test has been curtailed from 494 to 338. In addition, the age limit for applicants to the open recruitment exam has been extended from 35 to 40 temporarily.

23 occupational groups and 79 job areas have been simplified to 11 occupational groups and 56 job areas in line with the changing military environment and restructuring efforts to cultivate efficient personnel management and promotion systems. The promotion review system for military civilians at Level 5 has also improved from paper examination selection.

Personnel exchange considering the location of residence has given way to a system of personnel exchange across the nation to increase organizational

efficiency. A replenishment system to fill the vacancies of personnel, who retire early with pay unto the legal retirement age, will be conducted along with a recruitment exam system that allows exam applicants who were on the waiting list to fill vacancies. The MND will improve and develop various educational tools for military civilians by position and Service to cultivate their capacity as professional defense personnel.

### **3. Education and Management of Professional Defense Personnel**

The MND has carried out the plan to entrust the education of professional defense personnel candidates to outside institutions. Professional defense personnel are capable of establishing and implementing policies based on their field experience and academic background and are supposed to be appointed to positions that cannot be filled by personnel with ordinary military careers and to such positions as designated by the Minister of National Defense.

**| Professional degree education** | Professional defense personnel candidates are selected and educated at prestigious local and overseas universities that rank among the world's top 100 to acquire new technology and knowledge. In the process of fostering defense professionals, the number of candidates is determined by a thorough analysis of the jobs to be carried out. The candidates' majors and the foci of their theses are designated as early as the candidate selection process.

The candidates who have received professional education at the Master's or Doctorate level are appointed to the positions designated. Their careers are monitored and managed according to their respective specialties, which are recorded in the organization chart. Six laws and regulations, including the Enforcement Decree of the Military Personnel Act, the Regulation on Entrustment of Military Personnel, and the Enforcement Decree of the Act on the Establishment of the Korea National Defense University, and related directives were revised in 2009. The directives for Military Education Entrustment Management were mapped out in 2010.

**| Capacity development education** | The number of military personnel who earn academic credits after day duty or on weekends increased

from 4,000 in 2009 to 5,200 in 2010 to cultivate professional skills of long-term serving officers and satisfy their desire for self-development.

| **Military education overseas** | Entrusting education to military educational institutions and research institutes overseas is being expanded to produce regional specialists with expertise in various countries and to help officers gain advanced military knowledge. The number of officers entrusted to overseas institutions increased from 370 in 28 countries in 2009 and to 420 in 30 countries in 2010. The number of officers entrusted to institutions in countries in which English is the official language increased from 180 in 2009 to 207 in 2010, in preparation for the wartime OPCON transition.

# Realignment of the Mental Strength Education System

The Ministry is committed to instilling a firm sense of their nation, a correct view on security and the military spirit (esprit de corps) in service members. It is developing the Mental Strength Education System, under which service members will be provided with education commensurate with their specialties and levels. This system will also allow for the content and educational strategies to be cultivated and the ideal preparation and support for the educational materials to be executed.

## 1. The Meaning and Contents of the Mental Strength Education System

Mental strength refers to the organized power of will of all service members in support of their commanding officers so as to proactively fulfill a given mission with firm conviction, strong discipline, high morale and steadfast unity. The MND is cultivating elite officers and soldiers who are capable of translating into action their sense of their nation (of what to safeguard), a correct security view (whom to defend the nation from), and their military spirit (how to defend the nation).

The MND is instilling a sense of pride in the nation's history, based on patriotism and a sense of conviction in the nation's legitimacy and the supremacy of the nation's liberal democratic system, in the servicemen and women to give them a firm sense of their nation. In addition, it has educated service members to raise their awareness of being 'democratic citizens in uniform.'

A firm sense of security and awareness of the enemy come from a clear perception of the military mission. The military mission is about protecting the nation from enemies who pose a grave threat to the existence and interests of the nation or from those who would render assistance and support to such enemies. A clear sense of military mission presupposes a correct understanding of North Korea's provocations against the South, including the Korean War and the attack on the ROKS Cheonan, the realities of North Korea and its military threat to the South, and the ROK-U.S. alliance, which is the lynchpin in the nation's security. The duality of exchanges and cooperation between the two Koreas and military confrontation on the peninsula should be clearly understood as well.

Since service members might have to dedicate their lives in defense of the nation in cases of conflict, it is essential to cultivate the six tenets of military spirit: honor, loyalty, genuine courage, firm conviction for victory, the spirit of never retreating on the battlefield, and patriotism. These elements serve as yardsticks for the spirit and action of service members and are crucial in determining the outcome of a war.

## **2. Developing an Educational System Befitting the Characteristics of a New Generation of Service Members**

Military mental strength education for service members is conducted at educational institutions and units. Officers are educated at educational institutions to build a sense of their nation, establish a correct view on national security and strengthen their ability to communicate with and educate the servicemen and women under their command. Mental strength education for recruits focuses on fostering a 'true soldier' and on instilling a sense of mission to ensure the correct sense of their nation, the correct view on national security and the other desirable values required of service members.

Military mental strength education at the unit level is divided into regular education and practical education<sup>1</sup> to help service members internalize their military spirit and duties as a way of life. Regular education is conducted on

### **1. Practical education**

Training and education for soldiers to naturally acquire and internalize military spirit in their daily routines, which encompass life in their living quarters, daily duties, unit activities to increase a sense of unity, military ceremonies and sports activities.

every Friday, also known as the Day of Military Mental Strength Education, when service members watch Korean Forces Network (KFN) TV programs designed to enhance their sense of the nation and to correct their views on national security and military spirit. Service members must conduct discussions among themselves after watching these TV programs to internalize the convictions sharpened by the programs. Practical education is led by the commanding officers on a routine basis. Various other methods are also being employed, such as inviting civilian experts lecture at the battalion level and lecture tours hosted by the Mental Strength Education Group at the Korea National Defense University.

Educational programs have been improved to encourage service members to actively participate in them. For example, a character building educational program<sup>2</sup> and on-site education, such as visiting battlefields, have been reinforced, and the content of military TV broadcasting and UCC videos has been modified to suit the disposition of the new generation, who are accustomed to the visual media.

**2. Character building educational program**

A program designed to help service members develop a positive mental attitude, new value system and mode of behavior by appealing to their sensibilities and rationality.

### **3. Establishing a Network for Security Education**

It is feared that the perception of the importance of national security is tapering off as the population of the post-Korean War (born) generation has increased in the last six decades since the War. However, national security is the responsibility of every citizen of the Republic of Korea, not just that of the service members. Schools, communities and the military must join hands in raising the popular awareness about the national security.

To this end, the MND is conducting security field trip programs by operating military camps for civilians, including teenagers. The purpose of these camps is to help the public naturally recognize the importance of national security by having them observe the sites of tense military confrontations between the South and the North. In particular, on the occasion of the 60<sup>th</sup> anniversary of the Korean War, security educational programs for the youth and the reserve forces by reservist lecturers are actively pursued.

## Section 3

# Cultivating Strong Warriors by Concentrating Efforts on Training and Education

The purpose of military training and education is to 'cultivate a strong military and strong warriors capable of fending off an enemy.' To that end, all service members and all units take part in combat-mission oriented training of real battlefield situations with the motto 'train as in fighting, and fight as trained' to fulfill their mission during wartime and peacetime. The MND is reinforcing the training and educational structure by reinforcing soldier-focused training programs; developing scientifically-advanced training systems; and providing the conditions that allow the military to concentrate on training and education without disturbance.

## 1. Strengthening the Training and Educational System for Service Members

**| The need to reinforce the training and education of service members |** Training and education is the bedrock of combat capabilities. Robust and war-like training and education must be conducted so as to perfect combat readiness, contribute to unit operation and keep morale and discipline. Service members, based on their strong spirit and physical strength, must acquire the knowledge and core combat techniques necessary for the execution of their mission according to their specialties and duties.

**| Training and education of recruits |** The goal of training and educating recruits is to produce elite soldiers able to perform their duty on the battlefield by cultivating their combat capabilities through training exercises designed to foster soldiers armed with military spirit. The intensity of boot camp training had not been set high enough. As a result, enlisted soldiers have had to undergo additional training after they have been dispatched to their units in order to match the standards of their seniors. Furthermore, as the term of service is gradually being shortened,



the dwindling number of skilled personnel requires that newly dispatched service members be collectively educated for a specified duration.

In the future, the quality of boot camp training will be enhanced by extending the training period, increasing the requirements in the core areas, and applying a measurement-based pass/fail system to ensure recruits are capable of fulfilling their missions upon dispatch to their respective field units. In the case of the Army, the new system will be phased in for all units from 2011. In terms of the Navy and Air Force, the system will be introduced with consideration for the requirements of the respective units.

### | Training and education for service members in field units |

The goal of training and education for service members in field units is to sustain their combat capabilities at a certain level throughout the year and ensure their victory in battles through tough combat-mission oriented training simulations. To that end, repeated training of worst case scenarios are conducted, core combat techniques are taught, and a measurement-based pass/fail system has been introduced. Those with poor performance are trained collectively in accordance with their performance levels.

Personnel dispatched to naval units undergo survival training in terms of mental strength, physical strength and marksmanship so that they will be fully capable of fulfilling their duty within three months of assignment, depending on their mission by unit and ship type. Air Force personnel are required to undergo intensive training to hone their ability to protect the nation's air bases and increase their expertise in their respective specialties.

## 2. Developing Scientific Training and Education

| **The need for scientific training and education**<sup>1</sup> | As seen in the Gulf War and the Iraq War, a future war is expected to be a network-centric, synchronized and integrated warfare. Hence, the ROK Armed Forces need to administer training and education to cultivate the capability to conduct network-based joint operations.

In the future, the number of personnel will be reduced as the military

### 1. Scientific Training and Education

Training and education drawing on advanced information, science and technology innovations in the form of digital devices, networks, cyber material, cyberspace, remote communication videos and distance learning equipment.

shifts to a state-of-the-art technology-intensive structure. Therefore, the ROK Armed Forces has to produce professional, elite personnel capable of skillfully operating sophisticated weapons systems and equipment.

Rapid urbanization of areas surrounding military bases is making it increasingly challenging to find space to perform field maneuver training and live-fire exercises, especially since the movement of combat gear, shooting exercises and night operations have been provoking a stream of complaints from the neighboring residents. To address such problems, computer-based simulated combat exercises will work as an effective alternative.

### | Scientific training and education of the field units |

The establishment of a Synthetic Battlefield System (Live, Virtual, Constructive)<sup>2</sup> in the field units is necessary to boost their joint operational performances and their ability to operate advanced weapons systems and conduct simulated exercises. The system is designed to maximize the effect of exercises by providing the same or similar battlefield environments.

As shown in Figure 7-1, live fire training, urban operations, maneuver training, virtual simulation training conducted in a simulator, and the Battle Command Training Program (BCTP) are conducted in different locations. However, under the Synthetic Battlefield System (LVC), those five different trainings are described to take place at the same place under the command of a single unit.

Figure 7-1. Conceptual Organization of the Synthetic Battlefield System (LVC)

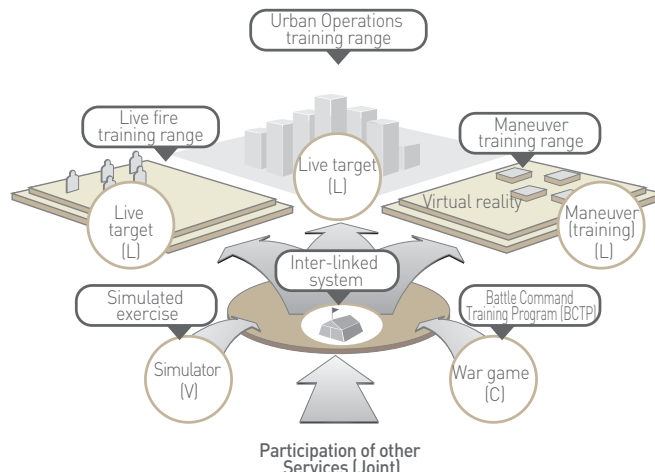

#### 2. Synthetic Battlefield System (LVC)

A training and educational system that enables maneuver training (Live), virtual exercises (Virtual) and war games (Constructive) to be carried out in a linked or separate manner.

- Maneuver training- field training that rely on training aids, training aid equipment, simulators, tactical devices fortified by simulation and a tactical engagement simulator.

- Virtual training - training that simulates real battlefields by using a simulator for various weapons systems and equipment.

- Battle Command Training Program (BCTP) - training for commanding officers and staff at levels between battalion and corps that incorporate war game models and simulation technology.

Units that are unable to commit troops directly can participate in the exercises held at the stations or unit training facilities through either the war game models or the simulated trainers at their bases or training ranges. The MND is currently in the process of developing this system for field units.

**| Scientific training and education at educational institutions** | A scientifically determined and technology-based training and educational system is being established at educational institutions in order to produce personnel resources fit for state-of-the-art technology-intensive military organizations of the future.

As shown in Figure 7-2, school education is divided into call-up education and distance education.<sup>3</sup> Call-up education provides practicum sessions by means of digital class activities, a cyber shooting range, a simulator, and three dimensional CBT. Meanwhile, distance education provides on-line technological and theoretical education by means of portals, cyber-instruction and an academic management system.

### 3. Distance Education

An on-line educational system that allows individuals or units to learn at their computers and from available information networks, without the constraints of time and space.

CBT Computer Based Training

Figure 7-2. The Conceptual Organization of Scientific Training and Education at Educational Institutions

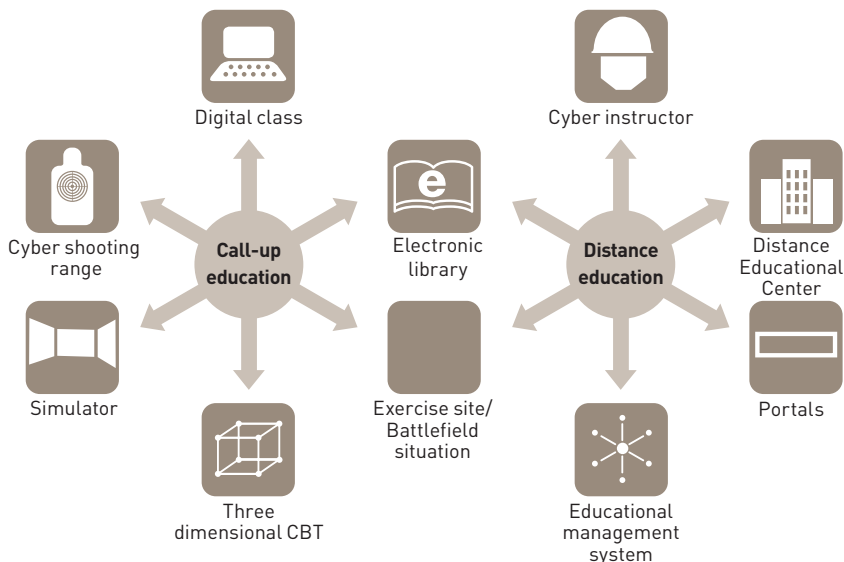

Scientific training and education requires a multimedia-based training and educational system, a network-based system for military knowledge, information and data, a distance learning educational system and a standing educational environment in which cyber instructors are available. A training and educational system and a material and knowledge acquisition system based on the use of multimedia are better suited for virtual hands-on training than for theoretical education as virtual battlefield situations can be portrayed on screen. Therefore, further preparations, such as digitization of classes, video manuals, digitization of military data, and the establishment of a search system for military knowledge and information must be undertaken.

The MND has endeavored to reduce call-up education in favor of distance education so as to ensure an environment in which field units can perform their missions without being disturbed whilst fostering a self-learning climate among service members. To that end, the Integrated Remote Defense Educational System,<sup>4</sup> which combines the distance learning systems being pursued by each Service, is currently under construction. In addition, in order to enable service members to self-diagnose their ability and enjoy high quality cyber classes, the MND plans to establish a omnipresent teaching system.

The MND is also committed to advancing the establishment of a scientific education and training system so as to maximize the effect of training and education at minimal expense and effort.

### **3. Establishing an Environment for Military Training and Education**

**| Increasing the efficiency of training ranges |** The MND is marshalling its resources to build an advanced elite military by pursuing the National Defense Reform Basic Plan, which involves restructuring the military organization and introducing sophisticated weaponry. Just as important as streamlining the military organization and introducing advanced weapons systems is securing training sites of suitable size and to administer actual warfare-like training and education to ensure the best combat performance in real-life situations. However, rapid development

#### **4. Integrated Distance Defense Educational System**

An integrated portal that is designed to manage military training and education in an integrated manner and support distance learning for each Service. The study over its concept was completed in 2009 and, currently, the preparatory work for system development is in process.

around the training ranges and the complaints filed by neighboring residents have made the use of these training ranges problematic.

To address these issues, the MND will redesign training ranges and integrate small-scale sites and infrequently used sites in phase on the annual basis to rearrange the training ranges by area.<sup>5</sup> Scheduled to be completed by 2020, the training site integration plan will ensure a satisfactory environment for actual warfare-like training and education, increase the efficiency of land use and ultimately contribute to improving the living environment of the public in general.

### | Operating a technologically advanced security system |

A technologically advanced security system is intertwined with defense reform and organizational restructuring of the military. A reduction in the number of troops is expected to generate difficulties in securing adequate frontline guards and security personnel in major military installations, such as corps or higher command, army aviation units, ammunition depots, naval bases and air bases. Therefore, a technologically advanced security system will replace the current system in core military installation areas, including the Military Demarcation Line area, to reduce the number of guards and to enhance the efficiency of guard duty. Such a technologically advanced security system is composed of surveillance, detection and control areas as shown in 7-3.

**5. Training Range Integration by Area**  
Under the training range integration by area plan, the scattered training ranges will be merged into other larger-scale training ranges or combined with nearby sites in consideration of the distance to the training ranges from military bases, number of trainees, training frequency and similarities between the training ranges.

Figure 7-3. The Composition of a Technologically Advanced Security System



The surveillance system monitors the encroachment of the enemy into the intensive surveillance zones mainly by means of cameras and surveillance radars. The detection system detects the cutting or crossing of barbed-wire fences. The control system controls the surveillance and detection systems.

The MND will continue to upgrade technologically advanced security system in conjunction with technological progress and link them to the unmanned surveillance and strike systems. The excess manpower generated by the establishment of this system will be channeled into mobile assault teams to improve the effectiveness of the surveillance. This will in turn enable the troops to concentrate on training and education and thus enhance their combat capabilities.

#### **4. Exercise and Training Simulating Actual Combat**

ROK forces are engaged in exercises<sup>6</sup> and training<sup>7</sup> that simulate actual combat in order to achieve the optimal level of preparedness for actual conflict. Especially, in preparation for the wartime OPCON transition, the ROK forces have been reinforced and have played the leading role in the ROK-U.S. combined exercises and training.

##### **| Combined/Joint exercises and training |**

**The Ulchi Freedom Guardian (UFG) Exercise** is divided into Government Exercises and Military Exercises. The Military Exercises train the ROK-U.S. combined forces to become familiar with the procedures for combined crisis management and for implementation of operational plans via computer simulations.

The Military Exercises were first conducted in the name of Focus Lens under the supervision of the United Nations Command in 1954. These exercises were added to the ordinary military exercises in the wake of the attempted infiltration of the presidential residence, the Blue House, by North Korean agents on January 21, 1968. It was intended that the combined forces would be trained on how to conduct a war and how to render assistance when conducting a war. Since 1976, the Military Exercises and Government Exercises have been carried out in an integrated manner under the term, the Ulchi-Focus Lens (UFL) Exercise.

#### **6. Exercise**

A process that adapts service members to the operational procedures involving planning, preparing for and implementing simulated war operations and maneuvers. In this process, all procedures and theoretical principles are as close to those applied in real operations as possible.

#### **7. Training**

An organized procedure that endows individuals and units with the technical knowledge and practical skills required to efficiently perform their designated mission.

·Combined training – training performed cooperatively by the military forces of two or more countries to accomplish a common objective.

·Joint training - training conducted under a mutually cooperative command structure, or a single commander, by two or more Services of the Army, Navy and the Air Force.

The UFG Exercise, known as the Ulchi Freedom Guardian (UFG) Exercise since 2008, has been conducted under the new combined defense system in preparation for the wartime OPCON transition. This exercise has helped foster ROK-supported and US-supporting operational performance capability at the theater level. However, with the North's attack on the ROKS Cheonan, in 2010, the UFG Exercise was conducted under the existing ROK-U.S. combined defense system, which focuses on deterring war. The UFG Military Exercises are participated in by ROK Army units at the corps level and above, ROK Navy units at the Fleet Command level and above, Air Force units at the Air Wing level and above, ROK Marine Corps Command, United States Forces Korea (USKF) and U.S. wartime augmentation units. As for the UFG Government Exercises, major administrative agencies at the city, gu (county) and gun (town) level and above and mobilized private sector entities are participants.

**Key Resolve (KR)/Foal Eagle (FE)** is a ROK-U.S. combined exercise carried out during the first half of every year. It is classified into Command Post Exercise (CPX)<sup>8</sup> and Field Training Exercise (FTX). Initially, the exercise was divided into the Reception, Staging, Onward Movement and Integration (RSOI) Exercise and Foal Eagle (FE) Exercise, being conducted separately. These two exercises, however, have been combined since 2002. Since 2008, the exercise has focused on reviewing and acclimatizing to the combined defense posture in preparation for the wartime OPCON transition and had its name changed to Key Resolve/Foal Eagle.

Being a command post exercise, this exercise is carried out as a computer simulation that cultivates the ability to conduct an operation, deploy US reinforcements to the Korean Peninsula and boost the war sustainability of the ROK forces. The exercise involves the Army at the corps level and above, naval units at the Fleet Command level and above, the Air Force at the Air Wings level and above, and the Marine Corps Command from the ROK side. Meanwhile, from the U.S. side, the Army Command, the USFK Headquarters, the Pacific Command in Hawaii, the Strategic Command, several units under the Transportation Command and reinforcement units all participate.

Foal Eagle (FE) is a field training exercise conducted to enhance combined and joint operations, combined special operations and rear-area protection operations.

#### **8. Command Post Exercise (CPX)**

Exercises designed to help the commanding officers and staff of each echelon within a unit to fulfill their missions. They are trained, maintaining communication under various situations, on moving command posts, the operational procedures for commanders and staff to follow, operational plans and application of established operational rules.

It started in 1961 as a small scale exercise to defend rear areas. Combined and joint operations and combined special operations were incorporated into it in 1975. Since 1982, it has been bolstered in preparation for infiltration by enemy special forces by adding the surveillance of rear areas, reception, staging, onward movement and integration (RSOI), special operations, ground maneuvers, amphibious maneuver operations and air assaults.

### | Joint exercises and training |

**The Taegeuk Exercise** is a theater-level command post exercise that is conducted every year, under the supervision of the Joint Chiefs of Staff, to identify areas of improvement in the joint forces and the force structure as well as to enhance the operational performance capabilities of the ROK forces during wartime and peacetime. The Joint Chiefs of Staff have been conducting the Taegeuk Exercise in the form of a command exercise since 1995 to refine its independent operational performance following the take-over in 1994 of peacetime operational control by the ROK forces. Since 1999, it has developed into a theater level joint command exercise involving the participation of operations command and is under the supervision of the Joint Chiefs of Staff.

The name, Taegeuk Exercise, has been in use since 2004. And since 2005, the Taegeuk JOS war game model, a simulated theater level joint operation developed by the Joint Chiefs of Staff, has been put to use. Since 2008, the emphasis has been placed on establishing a system that allows an operation to be conducted under the supervision of the Joint Chiefs of Staff and on improving its operational capability in preparation for the wartime OPCON transition.

**The Hoguk Exercise** is a field training exercise conducted every year at the theater and operational command level, under the supervision of the Joint Chiefs of Staff, to cultivate operational performance. The Army, the Navy and the Air Force conducted Sangmu (evergreen) Training, the Tonghae (passage) Exercise, and Pilseung [victory] Training, respectively, up to 1988, when they were all incorporated into the joint Tongil Exercise. The Tongil Exercise replaced the Team Spirit Exercise in 1996 and had its name changed to the Hoguk Exercise. Since 2008, it has been carried out in conjunction with the Army's corps level field training exercise conducted in every March.

The Hoguk Exercise has been elevated to a theater level field training that



incorporates the corps level exercises in consideration of the changes in the operational environment, training conditions and the force structure. The exercise is conducted to strengthen operational performance by enhancing the simultaneity, integrity and interoperability of the joint forces.

**The Hwarang Exercise** is a comprehensive rear area exercise conducted under the supervision of the Integrated Defense Headquarters and involves the participation of all national defense elements, such as civilians, public organizations, the military and the police. This is the expansion of the Comprehensive Training on Anti-infiltration to the Metropolitan Area so as to encompass the entire military. Comprehensive Training was formerly carried out by the 3rd Army Command from 1977 to 1981. The exercise is designed to acquaint the forces with operational implementation during wartime and peacetime, establish an integrated defense posture between civilians, public organizations, the military and the police and to raise a sense of security within communities.

### | Training of each Service |

**The Army** has been strengthening its practical exercises for each unit by 'combat-mission oriented simulations of real battlefield situation' with the motto 'train as in fighting and fight as trained.'

Combined Arms Training, designed to maximize the integrated combat capability, is conducted to organize and complement the combat weaknesses of each branch and the functions of the 1<sup>st</sup> and 3<sup>rd</sup> Field Army and the 2<sup>nd</sup> Operations Command. Combined Army Training is currently classified into biological, chemical and radiological operations, counter-fire operations, air assault operations and anti-terror operations.

The Army has been developing an exercise model composed of the Korea Combat Training Center (KCTC), the Battle Command Training Program (BCTP) and simulator-based training methods that allow soldiers to experience real-life combat situations. The KCTC enables the Army to train in an environment that closely resembles real warfare by relying on advanced technologies, such as MILES equipment, data communication and satellites, and simulating opposing forces. This exercise, currently conducted at the battalion level, will be extended to the brigade level. Mechanized units are also planned to participate in the exercise.

The conceptual organization of scientific combat training is shown in Figure 7-4.

Figure 7-4. The Conceptual Organization Map of the Scientific Combat Training

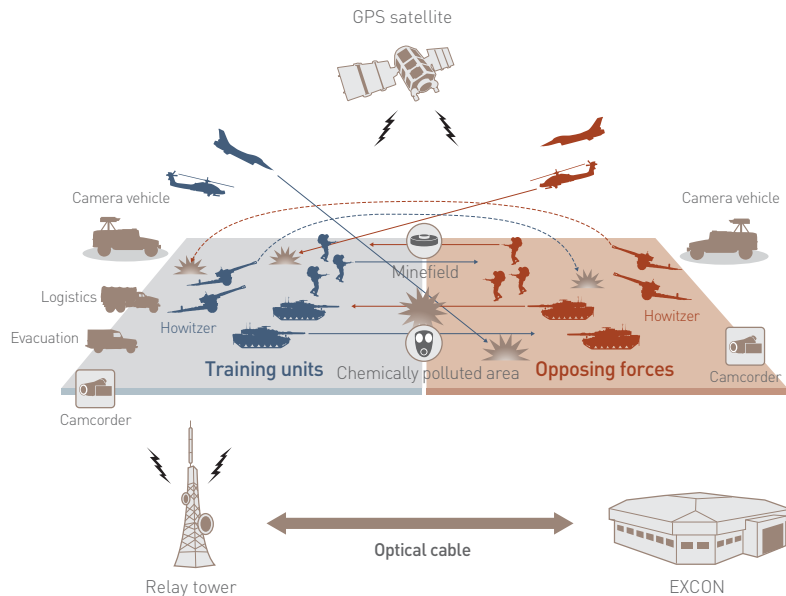

The Battle Command Training Program (BCTP) promotes the combat command capability of commanding officers and staff and relies on computer simulation techniques. Since 1999, the Korean type war game models the 'Changjo (creation) 21 Model,'<sup>9</sup> the 'Jeontu (combat) 21 Model,'<sup>10</sup> and the 'Hwarang 21 Model'<sup>11</sup> have been applied to training programs that simulate actual war conditions at the corps and battalion levels to train the commands on how best to command units and how to conduct combined combat missions. For corps and division level training programs, in particular, expert control officers and opposing forces (red forces) participate and the BCTP Group reviews the results of the training. In the future, computer simulation techniques will be utilized in connection with live field training to ensure more efficient and more realistic warfare-like training programs.

A simulator based exercise trains soldiers to shoot, maneuver and plan tactics on a virtual battlefield. A Simulated Training Center will be established at the corps and division level to develop exercise models for individual soldiers and in accordance with the battlefield requirements.

**9. The Changjo 21**

The BCTP Model for the Corps and Standing Divisions.

**10. The Jeontu 21 Model**

The BCTP Model for Regiments and Battalions.

**11. The Hwarang 21 Model**

The BCTP Model for the Homeland Reserve Division.

**The Navy** has been reinforcing its realistic maritime training by tailoring it to the East Sea, West Sea and South Sea respectively. It will upgrade its anti-submarine equipment and its operational capability through realistic exercises. To this end, it will secure an Anti-submarine Tactical Training Center to simulate anti-submarine operations characterized by a complex anti-submarine environment and a three-dimensional maritime power. The major exercises conducted by the Navy include Component Operational Training (via war games), Maritime Maneuver Exercises, Combined Exercises and Naval Academy Midshipmen's Cruise Training.

Component Operational Training (via war games) improves the Navy's combat capability for operations categorized by the combat components involved. Major exercises include the Anti-submarine Warfare Exercise, Mine Warfare Exercise, Amphibious Operations Exercise, Search and Rescue Operations Exercise, Special Operations Exercise, Submarine Warfare Exercise and Aerial Anti-Submarine Warfare Training.

The Maritime Maneuver Exercise trains the naval forces to secure early control of the seas in the event of a conflict and involves the participation of three-dimensional naval forces to perform multi-purpose rapid confrontational missions, such as cutting-edge surface combatants, maritime patrol aircraft, and maritime operational helicopters.

The Combined Exercise is divided into ROK-U.S. Combined Exercises, which strengthen the combined defense system, and the Multinational Combined Exercises, which increase humanitarian support and military cooperation. The ROK-U.S. Combined Exercises include the Maritime Counter Special Warfare Operations Unit Training, the Maritime Counter Special Operations Forces (MCSOF) Exercises, Infiltration Unit Training, Anti-Submarine Maritime Search Training, the Submarine Warfare Exercises, the Search and Rescue Operations Exercises, Amphibious Operations Training and the Special Warfare Exercises. Combined exercises with Japan, China and Russia include search and rescue operations exercises.

The Navy has been participating in the Rim of the Pacific Exercise (RIMPAC) and Pacific Reach (PAC-REACH), which are held on a regular basis, and



The Wanggeon engaging in short-range anti-submarine torpedo firing training



A squadron of patrol combat corvettes (PCC) engaged in maritime maneuver exercises

involved the participation of about ten countries, including the U.S., U.K., Japan, Canada and Australia, to cultivate multi-national combined operations and military cooperation. It has also been participating in the Cobra Gold Exercise to cope with various security threats and plans to participate in exercises conducted by the ASEAN Regional Forum (ARF) to promote defense capability.

Naval Academy Cruise Training is an annual training for midshipmen. It is conducted along four different sea routes by area, rotating the route each year, and lasts anywhere from 90 to 120 days. The exercise fosters the performance of duty by midshipmen, instill a global mindset in them and improve exchanges and cooperation with allies.

**The Air Force** has reinforced its combat mission-focused exercises that simulate the combat environment to maintain its readiness posture for immediate response against all types of threats and situations and to firmly establish the best operational posture. Major exercises include Defensive Air Superiority Training, Offensive Counter-Air Training, Air Interdiction Training and Close Air Support Training.

Defensive Air Superiority Training improves the ability to deter enemy air power from infiltrating the nation's territorial skies. It employs the available air defense resources to detect, identify, intercept and destroy simulated enemy planes, through the application of enemy infiltration tactics, at the farthest possible distance from their intended targets.

Offensive Counter-Air Training improves the ability to deploy offensive air power in the enemy's territorial skies to gain air superiority. Operational effect can be enhanced if the exercise is combined with in-depth strike resources, including ROK air power, ground-to-ground missiles, and special warfare units.

Air Interdiction Training improves the ability to disrupt, delay and destroy enemy reinforcements, or supporting forces, before they are moved to the frontline from their original locations in the rear areas and become a threat to ROK ground forces and the ROK Navy. The exercise is aimed at disrupting enemy power or delaying operational deployment by upsetting the reinforcement, replenishment and maneuvers (rapid mobility) of enemy in-depth strike resources.

Close Air Support Training is designed to improve the ability to render direct support to the ground forces and the Navy through attack exercises that utilize night vision goggles (NVG), live bombing training, and live PGM training.

The Air Force also conducts counter-fire operations exercises to render enemy's long-range artillery impotent and exercises to deter infiltration by enemy special operational forces along maritime routes. It carries out scientifically developed exercises that utilize simulated ground training equipment and air combat maneuver training equipment as their live mobile training is limited.

**The Marine Corps** has been intensifying its realistic training and educational simulations of actual combat in order to enhance its operational performance capability in any mission under any circumstances in the event of hostilities.

Major exercises include landing exercises, ROK-U.S. combined exercises, joint exercises, and combined overseas exercises. Landing exercises are conducted mostly at the division level and train forces aboard ships, landing craft and airplanes to land on enemy coastal areas. The ROK and the U.S. Marine Corps has been improving its combined operational capability through combined arms training, combined logistical exercises, engineering exercises, and combined tactical aerial control training.

The ROK Marine Corps have been participating in joint exercises, such as the Hoguk Exercise under the supervision of the Joint Chiefs of Staff, anti-coastal infiltration training, and joint training, such as reinforcements and defense training to protect islets in the North-West Sea, and in combined overseas exercises, such as the Cobra Gold Exercise and the Rim of the Pacific Exercise.

The Marine Corps has been conducting the Battle Command Training Program (BCTP) based on its indigenous *Cheonjabong* Model. It has been cultivating its practical combat capability by participating in the scientifically developed training initiatives of the Army at the battalion level every year.

It has been conducting various training, including landing and surprise attacks, airlifts, alpine training, special searches and exercises in arctic conditions. It has also been conducting the BCTP that utilizes computer simulation techniques to enhance the capability of the commanding officers and the staff.



F-4 Flights in formation for Air Interdiction Training



The ROKS *Dokdo* and armored vehicles engaging in a landing exercise.

## Section 4

# Improving the Educational System for Officers to Boost Jointness and Efficiency

The officer education system needs to be improved to help officers better understand the concept of jointness and to boost their ability to conduct missions in preparation for the wartime OPCON transition and the future changes in the battle field environment. The MND has been improving the operational system of its service academies to enhance their educational efficiency and to meet demands from the field. It is also developing a combined educational system for the Joint Staff College and colleges for each Service.

## 1. Improving the Educational System in Military Academies

The MND has been improving the curricula and faculty management system in the military academies to maximize their educational efficiency and sharpen their competitiveness at home and abroad.

**| Improving the curricula |** The purpose of improving the educational system in the military academies is to produce officers capable of performing their duties and to nurture outstanding workforces with great potential to become highly-qualified officers. Keeping in mind that the goal of the military academies is to foster elite officers, the educational emphasis has been shifted from the current degree oriented curricula to a balanced curricula comprised of military training, including character building and physical training, and education to instill a proper national identity and value system.

The curricula of the military academies, which differ from one another, have been simplified and standardized to ensure educational uniformity. Pragmatism has been strengthened as well by offering majors that best suit the needs of each Service. These improvements in the curricula will contribute to combat efficiency and jointness of ROK forces.

**| Improving the faculty management system** | It is vital that the Service academies secure faculty members of excellent caliber if they are to nurture officers with a competitive edge. To this end, they have increased their quota of civilian professors and improved the reappointment system for professors. Such measures will help convey quality education to the cadets and increase competition among the professors. The ratio of civilian professors in the Service academies, which was less than 10 percent as of August 2010, will be increased to 20 percent by 2020. The evaluative standards for reappointing professors will also be strengthened.

In January 2010 the MND established the Committee for Improving the Educational System of Military Academies. Composed of experts from home and abroad, the Committee's main aim is to improve the educational system. Thus, it mapped out an improvement plan, tailored to the local situation, based on a survey of about 2,000 officers who graduated from military academies, and research on the educational systems employed by the military academies of advanced countries and prestigious local universities, such as the Korea Advanced Institute of Science and Technology (KAIST) and Pohang University of Science and Technology (POSTECH). The plan will be put into effect in 2011 following further revision and review.

## **2. Improving the Joint Educational System for Officers (Lieutenant Colonels and Majors)**

The Joint Educational System for lieutenant colonels and majors will be drastically improved to reinforce the jointness between the three Services. Education related to jointness will start with majors rather than lieutenant colonels. The MND will produce a greater number of experts on joint operations by increasing the number of trainees by a large margin. It plans to integrate the Joint Staff College, the Army College, the Naval College and the Air Force College to establish the Command and General Staff College (tentative name).

The Command and General Staff College will recruit excellent candidates and educate them to serve in jointness-related positions so as to reinforce the jointness of the ROK military. In line with this, the personnel management system will be revised to give preferential treatment to graduates from the College when posts are assigned.



Commencement Ceremony for the Joint Staff College 2009

A group of men, some in suits and some in military uniforms, are standing in front of a large aircraft engine on display. The engine is a complex piece of machinery with various components, including a large fan and a compressor. The men are looking at the engine with interest. The background shows other parts of the aircraft and the interior of a museum or exhibition hall.

# Chapter 8

## Enhancement of Management Efficiency

- Section 1.** Enhancing the Efficiency of National Defense Resource Management
- Section 2.** Optimizing Defense Resources through the Use of Public and Private Resources
- Section 3.** Improving the Procurement and Acquisition System of Weapons
- Section 4.** Developing the Defense Economy into a Growth Engine for the National Economy





Seoul International Aerospace and Defense Exhibition [Oct. 2009]

# Enhancing the Efficiency of National Defense Resource Management

Amid the persistent threat of North Korea, the defense budget needs to increase in order to implement projects for the restructuring of the military according to the national defense reforms, to modernize it and to improve the environment surrounding the military bases. However, demands to curtail the defense budget and reduce the number of troops are growing within society.

The management of national defense resources in the current climate thus needs to undertake epoch-making changes. Bearing this in mind, the Ministry has pursued a wide-range of reforms across the Defense Operations System by realigning the organization, enhancing the transparency and efficiency of contracting processes, and promoting efficiency in the supply and maintenance system. In addition, the introduction of a Total Life Cycle Management System (TLCM) has helped the Ministry to comprehensively and efficiently manage resources from needs assessment and procurement planning through to disposal.

## 1. Operational System of the National Defense Organizations

**| Rearrangement of upper level organizations and directly controlled organizations |** As the number of troops is reduced in line with the defense reforms, the complete formation of combat units would require converting the manpower of non-combat units into combat units. Hence, the MND has been rearranging the upper-level organizations and directly controlled organizations.

In 2008, the MND reshuffled the headquarters of each Service in order to help them function more suitably for administrative military work, such as for the build-up and maintenance of military power and the support for military operations during wartime. In 2009, it rearranged four directly controlled organizations. In the Korea National Defense University, academic administration and student management functions were integrated, and the Railway Transportation Support Team, under the Defense Transportation Command, was dissolved so as to achieve a leaner structure. Outsourcing of welfare facilities contributed to streamlining the Gyeryongdae Service

Support Corps and reinforcing the support capacity of the Corps. The headquarters of each Service have also been making efforts to realign their inefficient non-combat organizations through internal evaluations of each.

Therefore, the MND cut the number of troops by approximately 10,000 from 2008 to 2009. Since 2010, as part of such efforts, it has also evaluated around 20 units under its direct control, including the Korea Defense Intelligence Agency (KDIA) and the Defense Security Command. In the future, the MND will continue to restructure its directly controlled organizations to increase the efficiency of both organization and human resources management.

**| Shaping a capable organization by realizing a model of creative administration |** The MND has been striving to achieve open defense administration by becoming a 'model of creative administration.' In one area of its efforts, it has identified the key issues facing the public and offered practical solutions that address their problems and improve their living standards. In so doing, an enormous budget and a grand campaign are not necessarily required. Instead, small changes can make a big difference in the lives of the public. In 2010, by meeting with local governments, including the Gyeonggi Provincial Government and the Gangwon Provincial Government, the MND managed to ease the inconvenience experienced by local residents living near military bases due to the military operations and training.

Within the military, the MND has also improved various systems and institutions, such as the previously unreasonable administrative process. It is also canvassing sound policy alternatives from front line units by encouraging them to make suggestions regarding military polices as shown in Table 8-1. In this way, the MND is attempting to establish a culture of communication with its troops.

**Table 8-1. Defense and Military Policy Suggestion**

Unit: No. of cases

Classification	Received	Result of Evaluation						Unaccepted
		Gold Prize (Order of National Security Merit)	Silver Prize (National Security Medal)	Bronze Prize (Presidential Citation)	Outstanding Effort Prize (Prime Minister's Citation)	Participation Prize (Defense Minister's Citation)	Total	
2008	70	1	2	3	5	25	36	34
2009	86	1	2	3	5	29	40	46

## 1. National Defense Knowledge Management (e-jisaem)

A management system that produces and enables the use of the knowledge required for creating new values when conducting national defense-related tasks.

Aside from this, the MND has held open contests on certain themes, altered the authorization procedures to make them more reasonable, invigorated e-jisaem<sup>1</sup> and study clubs, and provided incentives to those who have exhibited exemplary or creative job performances and accomplished good results based on that creativity. In addition, in March, 2010, the Joint Chiefs of Staff introduced the Government's standard business management system, the 'Onnara System,' which has been used by central government agencies since 2007, with the intention being to extend the system to the entire military by 2012 in order to enhance the efficiency and responsibility of administrative management.

**| Enhancing expertise in the MND Headquarters |** To alter the defense policies to align with the policy directions of the Government in a reasonable way and to deal with the different interests of each Service in an objective and a balanced manner, the MND has been annually increasing the proportion of civilian public employees in its headquarters and implementing a series of policies to enhance their expertise.

First, the MND set up the MND Plan for Promoting Civilian Control, which is essentially a plan to increase the proportion of civilian public servants until they account for up to 70 percent of the total MND employees, and it has enacted this plan in the National Defense Reform Act and its enforcement ordinance. Consequently, the civilian employee ratio increased to 65 percent as of October 2010 from 52 percent in 2005, with the proportion of civilians at the senior and junior director level reaching 70 percent. Still, the MND has not yet met its original goal of over 70 percent civilian employees in each level by 2009, and due to a government policy that limits increases in the number of public servants and the failure to find qualified civilian personnel to fill the vacant positions, some division chief level positions are now filled with active duty personnel, rather than civilians. However, the MND expects such issues to be addressed in the near future.

Second, the MND has consistently reviewed each job description to figure out which jobs require civilian administrative know-how and which require military expertise in order to meet the goal of the MND Headquarters' policy tenet of

enhancing expertise. Under the tenet, it has aligned the proportion of civilian public employees and military personnel within the organization.

Third, the MND has also increased the hiring of military experts, specialists with Master's and Doctoral degrees and outstanding personnel selected through an open recruitment process for Level 5 positions. At the same time, it has introduced the Career Development Program (CDP) and designated specialized positions, thereby rearranging the position management-related systems into a more structured organization. In addition, the MND has been operating around 20 military specialized educational courses, while refining the training and educational systems according to the position levels and specialized assignment.

## 2. Contract for Logistics and Facilities

**| Realignment of contracting entities in the military |** When contracting logistics supplies and facility construction projects from outside businesses, multiple organizations, such as the Defense Acquisition Program Administration, the Defense Installations Agency, the Central Finance corps of each Service, the Logistics Command of each Service, and their units have all been involved. However, this decentralized system has created inefficiency in the contracting process. Hence, the MND is planning to streamline the number of organizations in charge of the contracting process to include the Defense Acquisition Program Administration, the respective Central Finance Corps and the respective Logistics Commands of each Service, as shown in Figure 8-1, in order to increase the expertise, transparency and efficiency of the contracting procedures.

Figure 8-1. Realignment of Contracting Entities and Specialization Plan

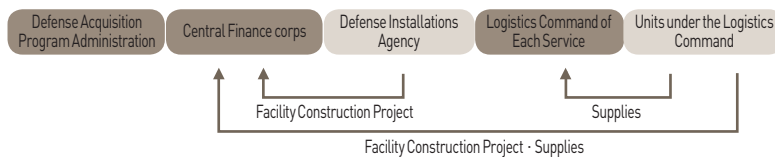

The Defense Acquisition Program Administration will be responsible for the contracts pertaining to military weapons systems and repair parts; the Central Finance corps will handle the contracts for facility construction projects and item supplies; and the Logistics Command of each Service will be in charge of the contracts related to supply procurements for its units. Meanwhile, each unit will take care of minor contracts, such as small-scale facility maintenance and item supplies. The Defense Installations Agency will be in charge of the private financing Build-Transfer-Lease (BTL) project, the purchase of real estate, the administration of construction projects, and follow-up management tasks.

The MND also intends to trim labor and reduce its budget by integrating the Central Finance corps of each Service. The integrated ROK Central Accounting Group (proposed name) will take full charge of those contracts regarding military construction for the entire military and the supplies procurement contracts requiring specialized knowledge and skills, such as cost accounting.

**| Expansion of competitive contracting cases |** The MND has expanded competitive contract bids regarding logistics and facility construction projects to enhance transparency and efficiency in the contracting process. In fact, it has avoided using regular commercial items according to the specifications for civilian commercial goods and has purchased items using the military specifications in most cases. Hence, regular suppliers were not able to participate in the bidding process. However, going forward, the MND plans to apply commercial specifications, rather than military specifications, to a wide range of military supplies except for items that directly affect combat strength or items exclusively for military use. While logistics supplies are being procured through competitive contracts, the MND plans to minimize the application of military specifications to new logistics supplies.

The MND also plans to expand the Public Procurement Service entrustment to include commercial items, such as various office supplies and fixtures, whose purchase was not entrusted to the Service, and items for which quality assurance is straightforward.

### 3. Supply, Transportation and Maintenance Support System

**| Supply** | The MND is striving to enhance the management and cost efficiency of national defense operations by making use of governmental and civilian resources and by actively introducing advanced management methods. As part of these efforts, it plans to establish a Consolidated Military Logistics Center in connection with governmental and civilian logistics systems. Developed into a supply base, the Consolidated Military Logistics Center will integrate a variety of logistics facilities for supply, maintenance and transportation. The Center will be furnished with cutting-edge information systems, including modern, standardized facilities and equipment that are linked with the Integrated Logistics Information System. The implementation of this plan will enable a speed-oriented, one-stop supply system, which will reduce inventory stocks and related expenses by guaranteeing that supply requests will be fulfilled within one day across the entire military. The conceptual organization of the Military Consolidated Logistics Center is shown in Figure 8-2.

Figure 8-2. The Conceptual Organization of the Military Consolidated Logistics Center



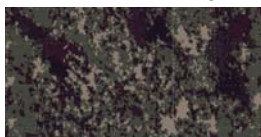

The Color of the Next-Generation BDU

In addition, the MND has implemented the Comprehensive Plan for Clothing and Outfits to improve the quality of these items in order to maximize the survivability and combat capabilities of combatants in future battlefield environments, enhance the level of welfare for service members and boost their morale.

The plan to upgrade the battle dress uniforms (BDUs) to the next-generation type is a prime project that the MND and the Ministry of Knowledge Economy began to implement since signing the Memorandum of Understanding on Next Generation Defense Textile Development in March 2010. The new BDU was designed in a way that the shirt overlays the pants without being tucked into to enhance combat efficiency, and attachments are easily attached or detached from the uniform through Velcro fasteners. The uniform features ‘granite patterns in five digital color shades,’ which easily blend in with the natural environment of the Korean Peninsula, where granite is the most common rock, thus making camouflaging easier.

Besides, the top quality functional winter clothing — made of enhanced thermal, moisture resistant, and ventilative textiles — was developed for troops that carry out ambush operations in areas with extreme temperatures and the distribution of functional combat boots will be expanded. The quality improvement of individual tents, combat backpacks and is in process, and all future military supplies will also have the newly developed digital pattern.

**| Transportation |** The Defense Transportation Information System, which enables the integrated operation of civilian, public organization and military transportation assets, is under development to efficiently support joint and combined special operations and establish the fundamental system for an integrated transportation system of the armed forces. The Defense Transportation Information System enables the integrated command and control of the transportation assets of the Army, the Navy and the Air Force. It also allows tracking information regarding the locations of troops and movement of cargo between a point of departure and a point of arrival, thus it enables a speed-oriented Integrated Transportation Support System for the Armed Forces.

At the same time, the military plans to introduce a commercial vehicle<sup>2</sup> lease system<sup>3</sup> that would allow up-to-date vehicles to be rented from private car suppliers while keeping its transportation assets to a minimum. The plan will be first piloted and evaluated by administrative and support units, and based on the results of the evaluation, it will be gradually expanded to other units. With the introduction of the

## 2. Commercial Vehicle

Vehicles for general use, such as regular passenger vehicles, buses and trucks.

## 3. Lease System

The system allowing for one to rent a vehicle from its owner by paying an agreed upon rental fee.



lease system, the dissatisfaction of users over the decrepit vehicles will be lessened, and the cost and workload for vehicle management and maintenance will be reduced, thereby ensuring safe driving and cost savings.

**| Maintenance** | The MND is building a National Maintenance Support System that makes full use of outstanding governmental and civilian resources in order to improve the maintenance of combat gear and the operational rate of equipment in light of the fact that as the cutting-edge precision weapons systems with multiple-functions increase in number so too are the maintenance environments changing. To shift the current military-centered maintenance system to a national maintenance support system, governmental and civilian facilities and overseas specialized facilities will be utilized for the maintenance of the new types of the cutting-edge precision gear to be introduced, while the conventional gear currently in operation will still be maintained using current military maintenance assets. The plan to improve the current maintenance support system is shown in Figure 8-3.

Figure 8-3. Improvement of the Maintenance Support System

		Current	Future	
			Conventional Gear	Cutting-Edge Precision Gear
Military	I. User (Individual)		I. On-Site Maintenance (Regimental and Battalion Level + Division and Brigade)	(On-Site) Maintenance by Units: Replacement, One-day basis
	II. Maintenance by Unit (Regimental and Battalion Level)			
	III. Direct Support for Maintenance (Division and Logistics Support Command)			
	IV. General Support for Maintenance (Logistics Support Command)			
Maintenance by Military and Civilian Suppliers	V. Depot Maintenance (overhaul/repairs)	Utilization of the Governmental Maintenance Support System	II. Field Maintenance (Logistics Support Command)	Depot and Outsourced Maintenance (Depot, Civilian Suppliers, Overseas Maintenance)
			III. Depot Maintenance (overhaul/repairs)	

For malfunctioning equipment, on-site maintenance capability will be strengthened with a focus on parts replacements to ensure early recovery of equipment at combat sites. As shown in figure 8-4, the Remote Maintenance Support System,<sup>4</sup> which uses the high-speed information network, is under construction. With respect to the maintenance depots of each Service, advanced technologies in the private sector will be benchmarked, while developing and expanding the military’s own maintenance technology, so as to enhance the efficiency of depot maintenance<sup>5</sup> in tandem with the innovative management of maintenance work.

**4. Remote Maintenance Support**

The provision of support for maintenance or undertaking the maintenance itself through remote access to the concerned (problematic) system in a manner that allows the operational units and the maintenance units to communicate with one another via video, text or voice using the Satellite Communications Network or other information and communications systems.

**5. Depot Maintenance (overhaul/repairs)**

Maintenance that cannot be handled by the field units, such as disassembly, inspection, repair, regeneration, renovation, and manufacturing that require special maintenance facilities, special equipment and tools.

**6. PBL (Performance-Based Logistics)**  
 A system whereby suppliers of equipment are paid according to how well their supplied equipment performs and their maintenance services are provided, based on a Result Index (e.g., target operational ratio) made by the military that uses such equipment.

In order to increase the operational ratio of equipment by steadily procuring more inexpensive parts, the MND, together with the Small & Medium Business Administration (SMBA), has implemented the Joint Project for Defense Technology Development for the development of maintenance technology, while replacing imported parts with locally produced parts. In terms of special and sophisticated equipment, which the military has trouble maintaining, the Performance-Based Logistics (PBL)<sup>6</sup> Support System will entrust maintenance to specialized civilian manufacturers in consideration of the characteristics and operational environments of each piece of equipment and its cost.

**Figure 8-4. The Conceptual Organization of the Remote Maintenance Support System (example of naval vessel)**

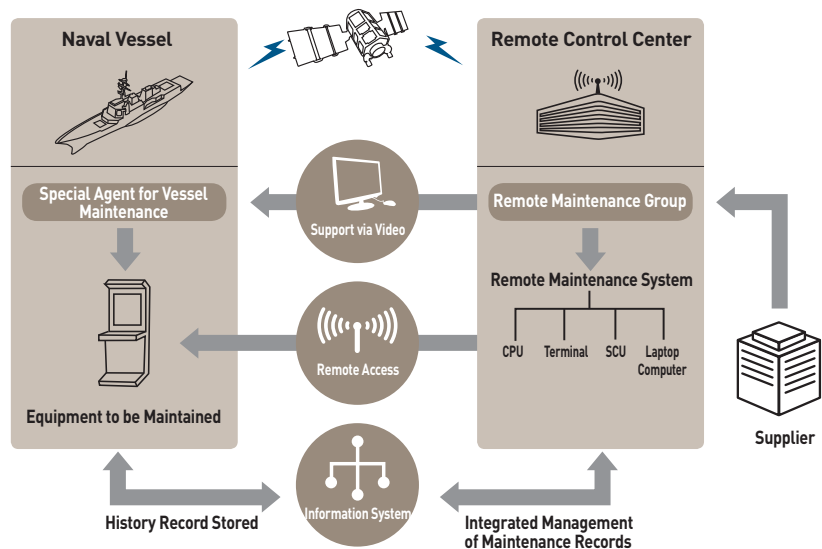

#### 4. Establishment of the Total Life Cycle Management System (TLCM)

**| Integrated management throughout the total life cycle |** The MND set up the Total Life Cycle Management (TLCM) System to manage the entire life cycle of military supplies, from the initial development, procurement, and operation/maintenance through to disposal, in an efficient and cost-effective manner. Currently, the ROK military’s weapons systems are operated by different organizations and under different budgeting systems, depending on its life cycle stage. This easily helps partial optimization at each stage but not throughout the

entire life cycle from a holistic perspective. Therefore, the TLCM System is now under construction to strengthen the link between different stages of needs assessment, procurement and operations. For example, under the System, an optimal development plan, in consideration of the operational/maintenance factors, can be produced during the initial stages. The conceptual organization of the TLCM is shown in Figure 8-5.

Figure 8-5. The Conceptual Organization of the Total Life Cycle Management System

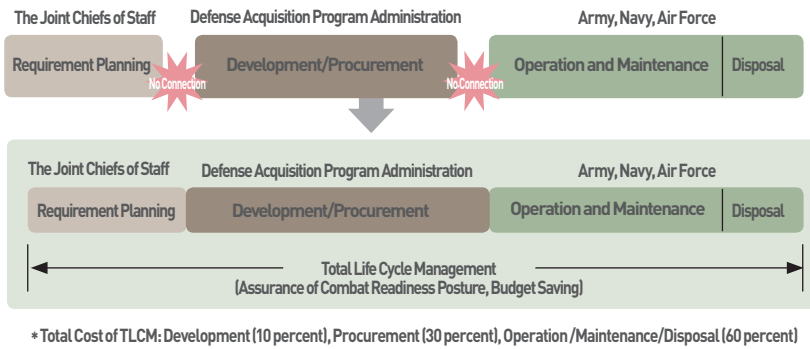

**Reinforcing the links between requirements, procurement and operation/maintenance** | The basic purpose of the TLCM System is to reinforce the links between the different work stages: (force) requirement generation, procurement, operation and maintenance, and disposal in order to ensure a combat readiness posture and reduce the total cost of the TLCM. The basic direction of the TLCM System is shown in Figure 8-6.

Figure 8-6. The Basic Direction of the TLCM System

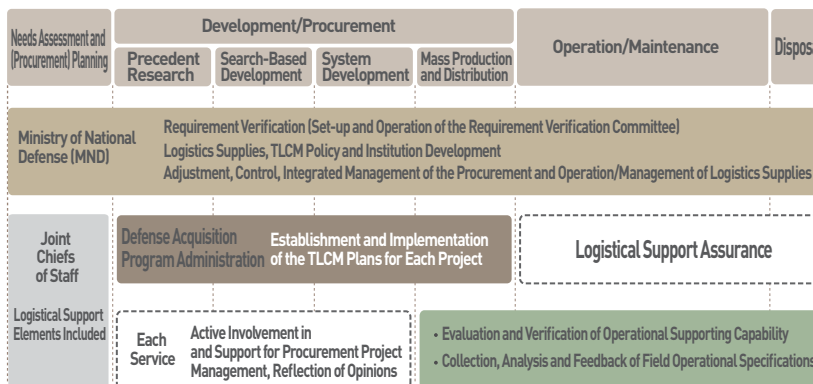

To this end, the MND will verify the validity and accuracy of the needs (of the military); develop TLCM-related policies and institutions; and adjust and control the procurement and operation/maintenance for life cycle management in an integrated manner by establishing the Requirement Verification Committee. The Joint Chiefs of Staff will identify the relevant logistical needs and create a plan for logistics support, which is necessary at the operation/maintenance stage when the target operational ratio and cost throughout the life cycle of military supplies are determined. The Defense Acquisition Program Administration is responsible for optimizing the performance of a weapons system, its developmental period and cost throughout its life cycle. It is also in charge of mapping out and implementing a life cycle maintenance plan for each project to ensure logistical support at the operational maintenance stage. Each Service evaluates and verifies its operational support capability; collects and analyzes information and data related to malfunctions, maintenance and operations; and provides feedback based on the analysis during the next development and procurement stage.

# Optimizing Defense Resources through the Use of Public and Private Resources

The ROK military is converting to a system that maximizes the support and use of private and other national resources from its current self-supporting system, in which all needs are taken care of within the military. When the military actively utilizes the advanced facilities, superb manpower, and outstanding management methods of private sectors and optimizes military resources, including troops and facilities, it will be able to establish a low-cost, highly efficient operational support system. In addition, the related industries will be invigorated, and the overlapping investment between the military and civilians or government agencies will be minimized at the national level.

## 1. Expanding the Use of Civilian Resources

The military's use of private resources used to be confined to certain areas, such as education, maintenance and facility management to a limited extent. However, with the recent full-fledged defense reform efforts, the military has been expanding the scope of its use of private resources to encompass supply, transportation, training and other core non-combat areas. In addition, unlike the simple outsourcing of the past, it has been diversifying the means such as operating Military Executive Agencies and entrusting some areas to private entities.

**| Operation of the military executive agencies |** The MND has established Military Executive Agencies to introduce private management techniques to non-combat management activities. The Military Printing Depot, the Armed Forces Capital Hospital, the Army 2nd Supply Group, the Navy Supply Depot and the Air Force Supply Depot 40 were selected for pilot operations, and since January 1, 2009, the Military Executive Agencies have been running in earnest in these military organizations. The pilot operations in 2009 yielded positive results as shown in Table 8-2. The MND plans to expand the Military Executive Agency System to other organizations, following the evaluation of the pilot operations in the

**The Plan to Implement the Military Executive Agency System**

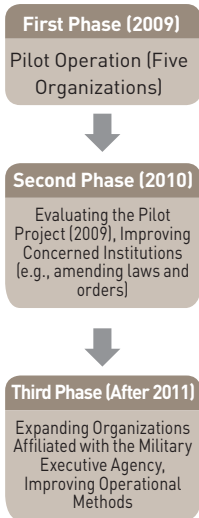

**1. Comprehensive Plan to Fully Utilize Civilian Resources**

Area		Business
Non-core Area		Outsourcing of General Low Level Jobs, Such as Facility Management
Core Area	Supply	Establishing a Consolidated Logistics System through the Use of the Public and Private Logistics Systems
	Transportation	Commercial Vehicle Leasing
	Welfare	Outsourcing of Catering for Officers' Dining Halls
	Training and Education	Expanding the Hiring of Civilian Instructors

five aforementioned organizations.

**Table 8-2. Major Accomplishments of the Military Executive Agencies**

Agency	Major Accomplishments
Military Printing Depot	·Reduction in the cost of outsourced printing: KRW 2.7 billion →KRW 1.5 billion (KRW 1.2 billion saved) ·Reduction in the lead time of printed materials: 15 days → 2.5 days (12.5 days saved)
Armed Forces Capital Hospital	·Increase in patient satisfaction: 75.7 points (out of 100) → 81.9 points (6.2 point improvement) ·The first military hospital to pass the Hospital Credibility Evaluation of the Korean Hospital Association
Supply Depot of Each Service	·Reduction in the handling period for imported goods: 9.7 days→ 4.2 days (5.5 days saved) ·Reduction in the handling of distributed goods: 7.6 days→3.8 days (3.8 days saved)

**Discovery and use of civilian resources** | In 2009, the MND established the Comprehensive Plan to Fully Utilize Civilian Resources<sup>1</sup> by identifying businesses in which civilian resources could be used across general non-combat areas, such as supply and transportation. In the first half of 2010, the MND solicited ideas for the best use of private resources internally and externally to the military, and it plans to continue exploring new projects that will complement the Comprehensive Plan.

The Ministry also plans to dramatically increase the use of civilian professors and instructors for training and education. As part of this effort, it will hire qualified civilian specialists as professors for the military academies, rather than fostering faculty members within the military, both to enhance the quality of education and to reduce its budget. Furthermore, the MND will replace those instructors on active duty working at scientifically advanced training sites with reservists, and thereby expand the employment opportunities of veterans or discharged soldiers.

In the supply area, the current logistics system has suffered from decrepit facilities, labor-intensive operations and logistics hubs that geographically overlap with one another due to the fact that each military has its own logistics center. Therefore, the MND has a plan to link the existing logistics system with the public and private logistics systems to the greatest degree possible in order to convert the system to a Joint-Military Consolidated Logistics Support System.

In terms of transportation, a commercial vehicle lease system will be introduced in some areas in order to optimize the use of military vehicles. In addition, a Fleet Management System (FMS)<sup>2</sup> will be introduced for the vehicles owned by the military in order to increase the operational ratio of those vehicles.

Further, the outsourcing of catering for officers' dining halls will be expanded to minimize the number of non-combat troops who work as unskilled labor. However, expanding the use of private resources only to boost management efficiency during peacetime may impede the full extent of combat strength being realized during wartime due to a possible delay in the mobilization of manpower and materials. Therefore, the MND will analyze the viability by conducting pilot operations first and expanding the use of public and private resources in phases, beginning in those areas where direct support through manpower and industrial mobilization is possible.

## 2. Expanding Joint Projects with Government Agencies

The MND has been enhancing the efficiency of its defense resources: on the one hand, it uses the military-owned assets for combat-related functions and, on the other hand, it uses governmental and civilian resources when providing support and other functions. Accordingly, the MND has been implementing joint-projects with concerned government agencies since 2009, and a Defense Cluster consisting of industrial, academic, research and military institutes<sup>3</sup> is under construction as part of the efforts to expand such cooperative projects.

Since 2009, the MND has been conducting joint-business ventures in cooperation with government agencies in the areas of equipment, textiles and clothing. Such joint projects have increased combat strength and enabled the introduction of advanced technologies and investments from the governmental and civilian sectors. Those civilian businesses and government agencies that provide resources, including cutting-edge technologies, for national defense will also benefit by making profits, thus contributing to the national economy.

The MND, in collaboration with the Ministry of Knowledge Economy, the Ministry of Education, Science and Technology and the Small & Medium Business Administration, is carrying out joint-business ventures in the area of equipment

### 2. Fleet Management System (FMS)

A control system that provides real-time information about vehicles, such as the location and status of a vehicle.

### 3. Defense Cluster Consisting of Industrial, Academic, Research and Military Institutes

An information exchange system regarding technology and research activities in which the industrial, academic, and research sectors communicate with the military for mutual technology and information sharing.

in order to improve the maintenance capability of the companies and to facilitate the research and development. This collaborative business venture system aims to actively engage investment by government agencies and establish a process in which the test equipment retained by each organization can be used in a joint manner, thus supporting the small and medium sized enterprises participating in the development of logistics parts.

Further, the MND has employed research and development support projects, research infrastructure and experts from the Ministry of Knowledge Economy to develop clothing and gears that meet the demands of the military.



# Improving the Procurement and Acquisition System of Weapons

The MND has been refining its weapons procurement sector and the Defense Acquisition System to ensure a timely supply of well-functioning weapons, equipment and other materials that meet the needs of users at the lowest possible cost. This effort will enhance the efficiency, cost-effectiveness and transparency of a Military Buildup and National Defense Management.

## 1. Weapons Procurement Sector

The MND has endeavored to provide optimal services to the public and the military by applying advanced institutions and scientific management systems to the projects for the improvement of defense capability. In the future, the MND will continue to improve the relevant institutions and systems in order to increase the confidence of the public in, and the transparency, efficiency and professionalism of, weapons procurement.

First, government agencies and the defense industry will set up a cost information-sharing system, while imposing stronger sanctions on illegal or unscrupulous vendors.<sup>1</sup> In addition, the MND will continue to develop institutional mechanisms to ensure that employees in the procurement area refrain from taking bribes or engaging in corrupt practices and conduct themselves with integrity in all procurement dealings.

Second, the MND will improve research and development (R&D) and purchase system to enhance efficiency in weapons procurement. For this purpose, the MND will invigorate the defense R&D structure, open it to collaboration with non-military

### 1. Illegal or Unscrupulous Vendors

A vendor that is considered unqualified to participate in contract bids because it might impede fair competition or fail to properly implement its contractual obligations.

## **2. Open R&D Structure**

A defense research and development structure that expands technological cooperation with civilians and involves the participation of the industrial, academic and the research sectors. It also reinforces the link with the national research and development sectors.

## **3. Integrated Defense Program Information Management System**

An information system that integrates those tasks related to defense projects and procurement management, while providing services inside and outside of the military. This system is operated in connection with the national defense and integrated governmental computer networks.

## **4. Scientific Business Management System**

A scientifically based business management system that utilizes such techniques as the Earned Value Management System, Systems Engineering, Simulation Based Acquisition, and Cost as Independent Variable.

## **5. Defense Technology Information Management Service (DTiMS)**

An integrated information system that provides a one-stop service for users by managing the domestic and international information about the latest weapons systems and defense science and technology.

## **6. National Defense Acquisition System**

A business system that aims to procure defense materials (weapons plus non-weapons).

entities<sup>2</sup> and expand investments in the R&D, upgrading the Agency for Defense Development (ADD), which is the nation's defense science R&D center, to a world-class R&D center. In addition, the MND will reinforce its bargaining power in negotiations with overseas sellers of goods and services by hiring a greater number of civilian specialists who are skilled in such negotiations.

Third, the MND will operate the Integrated Defense Program Information Management System<sup>3</sup> to quantitatively manage the achievements of the defense programs and apply Scientific Business Management Systems<sup>4</sup> to enable early identification and response to possible risk factors in projects through real-time (project) monitoring. At the same time, the Defense Technology Information Management Service (DTiMS)<sup>5</sup> will be built up to ensure that the technological information, which is individually managed by a defense-related organization can be shared with one another.

Fourth, the MND will install and operate educational programs, such as courses tailored to different jobs and cyber courses, in order to enhance professionalism of its staff. In addition, the MND plans to enact a Position Qualification System.

## **2. National Defense Acquisition System**

In the past four decades since 1972, when it introduced the Defense Acquisition Management Institution, the MND has endeavored to establish a Defense Acquisition System<sup>6</sup> that facilitates the rapid acquisition of better functioning weapons at a lower cost. In January 2006, the MND set up the Defense Acquisition Program Administration (DAPA) that integrated the acquisition-related organizations, which then belonged to eight different bodies, such as the MND, the Army, the Navy, the Air Force and so on. However, since the launch of the DAPA, institutional problems have occurred due to the budget of the projects improvement of defense capability and ordinary operating cost being separately planned and managed, which has led to the efficient use of the national defense budget not being fully realized. Further, it has become difficult to concentrate national energy and capabilities on national defense-related R&D and defense industry exports.

**| Achievements of the defense acquisition program administration** | Since its launch in 2006, the DAPA has been striving to enhance the transparency of the organization by introducing the Integrity Pledging System and an Ombudsman System and by adopting an open decision-making system that outside experts participate in. In addition, it has introduced the competition system in the defense industry. For example it eliminated the Specialization and Systematization System,<sup>7</sup> thus lowering the market entry barriers for the defense industry.

**| Difficulties in optimizing defense policies due to the separation of acquisition policies** | Despite such achievements, the DAPA has been exposed to one constant issue: the Administration has been completely responsible for various areas that were originally under the jurisdiction of the MND and the Joint Chiefs of Staff, such as setting-up acquisition policies, formulation of Medium-Term National Defense Plan and Budget regarding the projects for the improvement of defense capability, the final judgement on the results of Test and Evaluation.

First, acquisition policies, as a part of the entire national defense policy, should be organically linked with other defense-related policies. However, the policies have been independently implemented by the DAPA.

Second, the efficiency in managing the national defense budget has been reduced because the budget regarding the projects for the improvement of defense capability and ordinary operating costs are separately managed.

Third, policies related to research and development and the defense industry should be adjusted and controlled by the MND. However, the DAPA has been organizing these policies, and as a result, it has become harder to concentrate the national resources and efforts on collaborations with other government agencies and international cooperation.

**| Establishing an economical and efficient national defense acquisition system** | The MND has improved the Defense Acquisition System in a future-oriented direction in light of national interest enhancement and defense

#### **7. Specialization and Systematization System**

A system that was introduced in 1983 to facilitate technology development and to prevent defense businesses from inefficiently and overly competing with one another that could result in overlapping investments. Under this system, weapons systems are divided into subsystems according to the technology needed and the similarity of the platform. In the subsystems, finished equipment are further classified as specialized items, while components and parts are classified as systematized items. Suppliers that produce the items that fall within classification are selected within the system's guidelines, and the chosen suppliers win the right to participate in research and development, and production through the international technology cooperation.

management efficiency. The purpose of this effort is to enhance the consistency and efficiency of the defense policies by reinforcing integration and adjustment of the defense acquisition programs, and to secure transparency and professionalism in defense acquisition by ensuring the autonomy of the executive process to the greatest possible degree.

Further, while continually developing some systems that have been efficiently operated since the launch of the DAPA, other systems will be improved in a way that ensures acquisition-related organizations, such as the MND, the Joint Chiefs of Staff, the Army, the Navy, the Air Force, and the DAPA, can smoothly carry out their own original functions, while maintaining the collaborations between these organizations.

In the future, the MND will adjust and control the defense acquisition policies in line with the other defense policies, while establishing mid-term plans for defense acquisition, conducting research and development, and implementing policies related to the defense industry. The Joint Chiefs of Staff will determine the needs of the military according to the type of combat, while acting as the final judge on the results of the test and evaluation. The DAPA will be developed into an organization primarily responsible for the execution of policies, such as the management of concerned projects and contracts.

# Developing the Defense Economy into a Growth Engine for the National Economy

The MND, to the best of its ability, has maximized the achievements of national defense management. In spite of the difficulties facing government financing, it has secured a proper level of funding in the defense budget and allocated it in a reasonable manner to effectively respond to multifarious security threats and to successfully implement the defense reform plan. The defense budget has been spent on developing the entire national economy, beyond its main task of national security. The budget, for instance, has been allocated to develop technologies, invigorate the economy, vitalize industries, and produce technology experts. The MND has also been reinforcing its efforts on the policy front in various ways, including its efforts to facilitate defense item exports in order to realize the national goal of 'developing the defense industry into a new economic growth engine.'<sup>1</sup> Further, it has taken a leading role in advancing green growth and energy conservation.

## 1. Importance of Securing a Proper Level of Defense Budget

**Changes in defense budget allocation** | The defense budget as a ratio of the GDP and Government financing has changed according to the security environment and the fiscal status of the government. Until the early 1980s, the defense budget accounted for 5 percent of the GDP and reached 30 percent of the government budget. This was possible thanks to budget allocation that allowed the steady implementation of the mid-1970s military's self-reliant combat reinforcement plan, the *Yulgok* Project.<sup>1</sup> Meanwhile, due to the 1997 financial crisis and the increased demand for social welfare, the defense budget continued to decline from the late 1980s until the early 2000s. With the full-fledged pursuit of military reform in the late 2000s, the defense budget exhibited a slight upward trend; however, the ratio of defense budget as a percent of total government spending is still decreasing. As of 2010, the defense budget stood at 2.62 percent of the GDP and 14.7 percent of the total national budget. The changes in defense budget allocation are shown in Figure 8-7.

### 1. *Yulgok* Project

An initiative that was implemented from 1974 until 1992 to modernize the military. This initiative contributed to reinforcing combat power by developing and mass-producing M16 rifles and the Korea-type K-1.

► See Appendix 20: The Status of the Annual Defense Budget

Figure 8-7. Proportion of Defense Budget to GDP and Government Budget

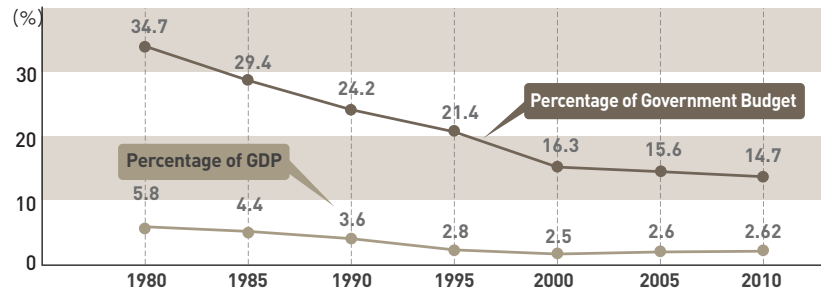

**|Importance of securing a defense budget corresponding to security conditions|**

It is desirable to strike a balance between the needs of the military in consideration of the current security threats and the government’s spending capacity, when determining the size of the defense budget. Hence, a country like the ROK, facing military confrontations, needs to ensure that a sufficient amount of the nation’s budget is allocated to defense in order to meet the military needs. Compared to various countries around the world, the ROK’s defense budget measured against the GDP represents a relatively low level of investment, despite the high level of security threats. The defense budget as a percentage of the GDP of major countries facing military confrontations is shown in Table 8-3.

Table 8-3. The GDP-Defense Budget Ratio of Major Countries in Conflict (as of 2009)

Unit: percent

Jordan	Georgia	Israel	U.S.	Cuba	Syria	Russia	Iran	ROK	Pakistan	China
11.0	8.0	6.5	5.0	4.0	3.5	3.0	2.8	2.8	2.6	1.6

\* Source: *The Military Balance* 2010 (London: International Institute for Strategic Studies, February 2010) and other relevant sources.

\* The percentages for Georgia, Iran, and Cuba were reported as of 2008

The defense budget per service member, which represents the quality of a nation’s military power, also remains extremely low. As of 2008, OECD member countries were reported to spend USD 182,782 per service member, while the ROK spent USD 35,677 or a mere 19.5 percent of the OECD’s average to give it a rank of 28th among the total 30 member countries.

### | Expected benefits of securing a proper level of defense budget

To ensure stable social and economic development, a firm security posture based on a proper level of defense funding needs to be maintained. Considering the military confrontations between the South and the North, in particular, the uncertainty surrounding the Korean Peninsula could yet give rise to a direct and fatal impact on the national economy.

Therefore, securing a proper level of defense budget may form a virtuous circle between security and the economy. That is, a proper level of defense spending can help establish a solid security posture, which would result in social stability and the nation's market economy being held in high esteem by the international community, bringing about economic growth. In addition, as shown in Figure 8-8, economic growth leads to an increase in tax revenue and expansion of government spending that would help secure a proper level of defense spending.

Figure 8-8. Virtuous Circle Involving National Security and the Economy in relation to Defense Budget

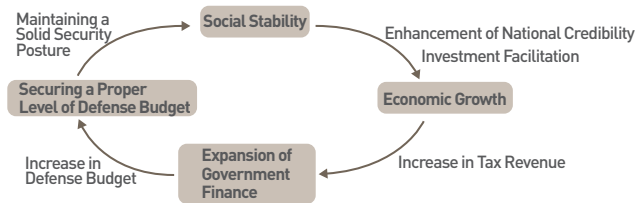

The expenditure of the defense budget is creating various economic ripple effects beyond its original purpose; maintaining a solid national security posture. Defense expenditure allocated to labor costs, including salaries for military personnel and military civilians, invokes consumer spending that in turn creates effective demand which invigorates industrial activities. Spending for the construction of military installations heightens the production and employment levels in various industries, such as the manufacturing and construction sectors, while increasing national income.

Cutting-edge technologies secured in the process of researching and developing the national defense arena have been extended to the private sector,

contributing to enhancing the productivity of civilian industries, including the electronics, telecommunications, and machinery industries. Major examples are shown in Table 8-4.

**Table 8-4. Examples of Defense Science and Technology Applications in the Private Sector**

Industrial Sector	Defense Science and Technology	Spin-off Examples in Private Sector
Information	Satellite Imagery Map Production	Navigation
Transportation	<ul style="list-style-type: none"> <li>• Welding and Processing to Produce Tanks</li> <li>• Military Vehicles</li> </ul>	<ul style="list-style-type: none"> <li>• Subway Trains and Railway Vehicles</li> <li>• Cargo Trucks</li> </ul>
Telecommunications and Electronics	<ul style="list-style-type: none"> <li>• Electronic and Guided Weapons and Radar Technology</li> <li>• Wireless Communications Equipment</li> <li>• Spread Spectrum and Synchronization Technology</li> <li>• Electro-Optic Detection Technology</li> </ul>	<ul style="list-style-type: none"> <li>• Anti-Car Crash Radar</li> <li>• Wireless Phones</li> <li>• Mobile Telecommunications Services</li> <li>• Videos, Digital Cameras</li> </ul>
Others	Tank Gunnery Simulator	Subway Train Simulator

The military has produced state-certified technicians and played the role of provider of national tech manpower through its own MOS training. It has produced a total of 41,871 state licensed technicians, including industrial and functional specialists, across the approximately 120 areas that encompass mechanics, chemicals, electricity and electronics (National Defense Statistics Year Book 2004 - 2008). In addition, around 54,000 technical experts in the fields of communications, aviation, and maintenance are produced every year, following their years of service in those areas of the military.

## 2. Defense Budget and Mid-term Defense Program

**| The 2010 defense budget |** The 2010 defense budget was set at KRW 29.6 trillion with a focus on promoting the welfare of service members and reinforcing combat strength in consideration of the North’s nuclear and missile threats. It has increased 3.6 percent year on year. The size of the defense budget and its allocation status is shown in Table 8-5.



Table 8-5. Defense Budget and Allocation

Unit: KRW trillion

Program		2009	2010	Increase/Decrease (%)
Defense Budget		28.5326	29.5627	1.0301(3.6%)
Ordinary Operating Costs	Troop Operating Costs	11.9096	12.1204	0.2108(1.8%)
	Operations and Maintenance (O&M) Costs	8.0083	8.3393	0.3310(4.1%)
	Total	19.9179	20.4597	0.5418(2.7%)
Force Improvement Budget		8.6147	9.1030	0.4883(5.7%)

The ordinary operating costs were set at KRW 20.5 trillion, an increase of 2.7 percent from the previous year. This budget will be spent mainly to increase the welfare of service members, assure the maximum performance of the existing forces, and produce elite standing forces. First, to enhance the welfare of service members, residential facilities, such as living quarters, military residences, and bachelor officer's accommodation facilities, have been targeted for improvement as early as 2012. To prevent early retirements of Air Force pilots, extended service benefits were introduced and private soldiers' allowances for sick-leave and holidays increased. Second, to assure that the existing forces are at the peak of their abilities, the need for major combat gear and maintenance were also reflected in the budget. In addition, the budget includes the costs required to improve the operational ratio of major combat gear, lower the superannuation ratio by replacing decrepit standard vehicles, and reduce the backlog of maintenance jobs. Third, to prevent a decline in combat strength, non-commissioned officers and paid support troops will be increased and practical training and education will be reinforced. To that end, the 2010 defense budget accounted for the needs of scientifically advanced training, which includes the use of CBT equipment.

The force improvement budget stood at KRW 9.1 trillion, an increase of 5.7 percent from 2009, with a focus on responding to the North's military threats, meeting the needs of military restructuring, and conducting national defense R&D.

First, the need for combat strength matching the recently increased military threats from the North was reflected in the budget. The ballistic missile early warning radar, the Aegis destroyer, 2<sup>nd</sup> round of F-15 K business, the next-generation ground-to-air guided weapons (SAM-X) and the other necessary systems will be procured within the budget. Second, theater operations command facilities, the K-21, and infantry combat vehicles will also be procured to meet the needs generated by military restructuring. Third, as part of the effort to 'develop the defense industry into a new economic growth engine,' the budget for weapons systems R&D was expanded to secure systems-development within the nation's capability.

In order to take follow-up measures in response to the attack on the ROKS Cheonan, the MND secured reserve funds totaling KRW 35.2 billion. Out of this fund, KRW 21.2 billion is being spent on reinforcing the search and rescue equipment and KRW 14 billion is being currently disbursed to upgrade the patrol combat corvette (PCC) and the Frigate each.

MND-related special accounting includes Special Accounts for the Relocation of Defense and Military Facilities, Special Accounts for Relocating USFK Bases, and Special Accounts for Construction of the Innovation City. The 2010 budget for special accounts administered by the MND increased 133 percent from 2009 to total approximately KRW 1 trillion and 48.8 billion. The status of the budget for special accounts is shown in Table 8-6.

**Table 8-6. Budget for the Special Accounts Administered by the MND**

Unit: KRW 100 million

Status	2009	2010	Increase/Decrease (%)
Special Accounts for Relocation of Defense and Military Facilities	2,218	2,600	382(17.2%)
Special Accounts for Relocating USFK bases	2,130	6,967	4,837(227.1%)
Special Accounts for Construction of the Innovation City	145	921	776(535.2%)
Total	4,493	10,488	5,995(133.4%)

The Special Accounts for the Relocation of Defense and Military Facilities was created to enable inner city military bases and facilities to be moved to the suburbs and to purchase private land that has been occupied by the military. In 2010, a total of KRW 260 billion was allocated to relocate the 1<sup>st</sup> Logistics Support Command and Seoul District Hospital. Regarding the Special Accounts for Relocating USFK Bases, KRW 696.7 billion was earmarked for facility construction in 2010 in accordance with the relocation of the USFK to Pyeongtak by integrating the USFK bases. The Special Accounts for Construction of the Innovation City was established in line with the Plan to Relocate Public Institutes to Local Cities (June 24, 2005). The costs of relocating the National Defense University fall under this Special Accounts allocation. In 2010, a total of KRW 92.1 billion was set aside to purchase the site and construct the necessary facilities for the University.

**| The 2011-2015 mid-term defense program (draft) |** The 2011-2015 Mid-term Defense Program (draft) focused on securing a stable budget base in consideration of the mid-term financial position of the Government in order to ensure continuous implementation of the Defense Reform Basic Plan and other national policies, and to meet the needs of existing forces to have their peak performance.

The size of the 2011-2015 mid-term defense budget (draft) is shown in Table 8-7. As noted in the table, the annual increase of the budget averages 6 percent, with ordinary operating costs and the force improvement budget increasing 4 percent and 10 percent, respectively.

Table 8-7. 2011-2015 Mid-term Defense Budget (draft)

Unit: KRW 100 million, %

Status	2010	Year					Total
		2011	2012	2013	2014	2015	
Defense Budget (Increase)	29.6 (3.6)	31.4 (6.3)	33.1 (5.4)	35.1 (5.9)	37.1 (5.8)	39.6 (6.6)	176.2 (6.0)
Ordinary Operating Costs (Allocation) (Increase)	20.5 (69.2) (2.7)	21.4 (68.2) (4.7)	22.2 (66.9) (3.5)	23.1 (65.8) (4.0)	24.0 (64.6) (3.9)	24.9 (63.0) (4.0)	115.5 (65.5) (4.0)
Force Improvement Budget (Allocation) (Increase)	9.1 (30.8) (5.7)	10.0 (31.8) (9.8)	10.9 (33.1) (9.5)	12.0 (34.2) (9.6)	13.1 (35.4) (9.5)	14.7 (37.0) (11.5)	60.7 (34.5) (10.0)

As for ordinary operating costs, the budget was set with a focus on establishing an advanced national defense operations system, ensuring that the existing force operates to its full combat potential, addressing the grievances of the field units, improving the conditions of the barracks to bring the living environment in line with the improved social conditions, and enhancing welfare of service members.

The force improvement budget was planned mainly to equip the military with the core and foundational combat strength necessary to enable proactive responses to varied future threats while effectively deterring the North. In addition, the need for combat reinforcements to implement the defense reforms were taken into account in budget planning, in consideration of the government's financial situation, and defense R&D was also highlighted in order to secure Korean indigenous weapons systems.

### **3. Developing the defense industry into a new economic growth engine**

As an integral security asset to assure national value and interests, the defense industry shares in the history of laying the nation's industrial foundation and is bringing about a tremendous technological ripple effect to other industries as defense research and development increasingly involves cutting-edge technologies. By advancing the defense industry, the MND will secure a cutting-edge force and further contribute to the national economy and industrial growth.

**| Defense industry exports |** In 2009, defense industry exports amounted to USD 1.16 billion, increasing 16 percent from USD 1 billion in 2008. In addition, the export market has jumped from 59 in 2008 to 74 countries in 2009, with exports diversifying to include electronics, telecommunications and vessels rather than the ammunition and maneuver equipment that were the main exports in the past. Defense industry exports over a five year period from 2005 are shown in Figure 8-9.

Figure 8-9. Defense Industry Exports over a Five Year Period (from 2005)

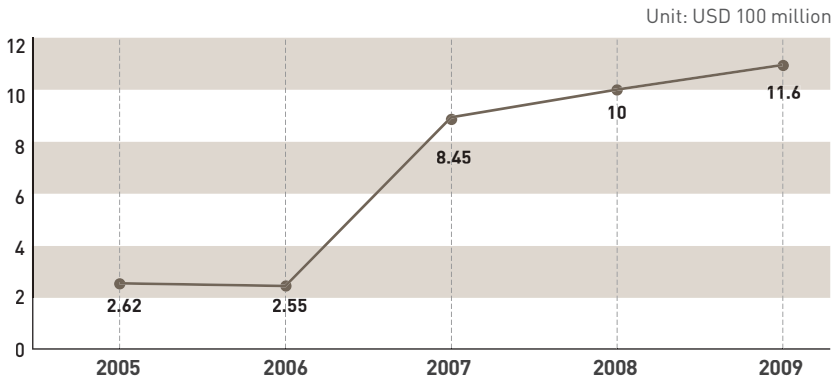

Year	Amount (USD 100 million)	Main Items	Major Countries
2005	2.62	F-15 K Parts, Self-Propelled Artillery Parts, KT-1 Trainers	34 countries, including the U.S., Turkey and Indonesia
2006	2.55	F-15 K Parts, Self-Propelled Artillery Spare Parts, Aircraft Maintenance Spare Parts, Unmanned Surveillance Robots	44 countries, including the U.S., Turkey and UAE
2007	8.45	KT-1 Trainers, K-3 Automatic rifles, Manufacturing service for the main wing of A-10 aircraft	46 countries, including Turkey, Philippines and U.S.
2008	10.0	Next-Generation Tank (XK-2) Production Technology, 155 mm Ammunition Parts, K-9 Self-Propelled Artillery Spare Parts	59 countries, including Turkey, U.S. and Egypt
2009	11.6	Ammunitions, Communication Equipment, Depot Maintenance on Submarines, Submarine Combat System	74 countries, including U.S., Iraq and Germany

The increase in defense industry exports is also a result of its active marketing efforts. The 2009 Seoul International Aerospace & Defense Exhibition (ADEX) held in October was attended by 273 businesses from 27 countries and 72 major figures from 41 countries, filling orders worth USD 360 million. The MND has also beefed up its efforts to penetrate overseas defense markets. In 2010, it held the Defense Industry & Military Logistics Joint Committee with 12 countries participating. Furthermore, it took part in six exhibitions held abroad, including Langkawi International Maritime and Aerospace Exhibition (LIMA).

In the future, the MND will strive to realize the national goal of 'developing the defense industry into a new economic growth engine' capable of playing an active part in developing the national economy. As for future defense industry exports, the MND will seek to achieve its target rank in the world's export market of the 10th position in 2012 and the 8th in 2015.

### **| Improving the conditions to foster the defense industry and encouraging its participation**

National and international competitiveness and systematic development of the defense industry requires advancing defense science and technology as a pre-condition. Considering this, the MND will increase its investment in defense research and development to 6.1 percent of the total defense budget in 2010 and 7.0 percent in 2012 in order to lay a foundation for the strengthening of defense R&D and future procurement. The Agency for Defense Development (ADD) will stimulate basic research in the core areas, such as aerospace technology and satellite navigation, while focusing on developing strategic and cutting-edge weapons technology as well as core and source technology. In addition, the MND will spur technology transfer (spin-on/off/up)<sup>2</sup> between itself and the private sector by strengthening their collaborations to ensure the market competitiveness of the defense industry and to attract investment for related enterprises.

The MND will provide funds<sup>3</sup> to the defense industry without delay to facilitate the defense exports, while gradually expanding the scope and areas of financial support. To enhance the production capacity of the defense industry, the MND will increase the use of domestically produced parts. To this end, it will continue to share information about different (defense-related) parts and strengthen its support of the development of core parts that have tremendous technological and economic ripple effects in other sectors.

### **| Strengthening the foundation of the defense industry by fostering defense-related small and medium sized enterprises**

Accounting for 70 percent of the entire defense industry, small- and medium-sized enterprises (SME) have laid a solid foundation for the defense industry through its original and differentiated technology developed in its core technology research and utilized in its development and weapons systems. To nurture defense-related SMEs, the MND will list the R&D fund for the Small and Medium Business Administration (SMBA) at the top of its budget allocation so

#### **2. Technology Transfer (spin-on/off/up)**

- Spin-on: Transfer of civilian technology to the military
- Spin-off: Transfer of military-owned technology to the private sector
- Spin-up: Joint development of technology commonly needed by both the private sector and the military

#### **3. Defense Industry Promotion Funds**

A system for the Government to provide long-term loans to defense businesses at low interest rates to promote the defense industry

as to support the production of domestic parts and the development of weapons systems as well as to provide consulting services regarding technology and management. At the R&D stage, SME-preferred items<sup>4</sup> will be selected and the supplier selection process will be refined to a 'one item-multiple suppliers' from the 'one item-single supplier' system. Further, the MND will make sure that information and news about the defense industry are always posted and updated on the websites of the SMBA and the Defense Acquisition Program Administration. The MND will also organize an exhibition designed to facilitate the development of defense parts together with the SME Win-Win Association.

**| Stimulating defense industry exports |** As the international defense market is continually growing, developed countries have strengthened their defense export support systems. Over recent years, the ROK's defense industry has seen a dramatic increase. Hence, the ROK Government is enhancing its efforts to support exports and is implementing strategies to systematically expand such support.

First, the MND will strengthen the competitiveness of the defense industry and its products. It will discover promising export areas with world-class competitiveness, such as the ship-building, automobile, steel and IT industries, while diversifying the items and subjects of its financial support. To expand governmental support for defense-related exports, the MND will provide quality assurance, while applying the royalty exemption system to items that have low price competitiveness. Further, the MND will cultivate export experts, sponsor meetings for CEOs, and expand its financial support of export businesses in the defense industry.

Second, the MND will pioneer overseas export markets and increase its marketing activities. For this purpose, the MND will map out export strategies tailored to each region and provide information regarding export support based on market analysis. In addition, it will increase military exchanges and cooperation among high-ranking officers, while expanding (international) collaboration in the defense industry and logistics sector. Further, the MND will strengthen governmental support for overseas marketing activities, take a leading role in penetrating new international markets, upgrade the Seoul International Aerospace & Defense Exhibition (ADEX) to become a world class defense-related event and foster the defense industry as a high value added industry. The export strategies and key export fields by region are shown in Figure 8-10.

#### **4. SME-Preferred Item Designation System**

A system that endows preferred vendor status to SMEs that take direct part in the development of specific items to foster outstanding SMEs with technological prowess.

**Figure 8-10. Defense Industry Export Strategies and Key Export Fields by Region**

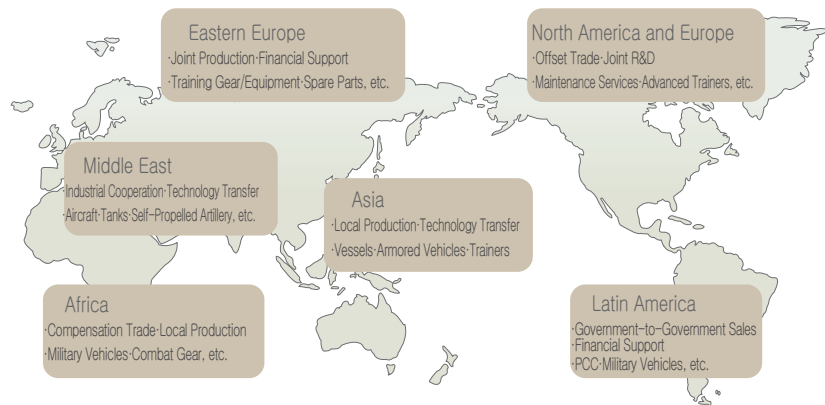

Third, the MND will secure and expand the infrastructure to support defense industry exports. As part of the efforts to reinforce the support of exports, it will make full use of the Export Support Council for Defense Commodities and the Support Center for Defense Commodity Trade at the government-level. In addition, in the mid- and long-term, a special Defense Commodity Export Support Agency will be installed to increase the exports of defense supplies. Export Support Institutions, such as the Government-to-Government Sales System (FMS)<sup>5</sup> and the Defense Exports Follow-up Logistics Support System,<sup>6</sup> will be created as early as possible. In addition, with the development of the Defense Export Control System and the Industry Export-Import Support Information System, information exchanges between concerned government agencies will be enhanced.

**5. Government-to-Government Sales System (FMS)**

A system in which the Defense Acquisition Program Administration or the Korea Trade Investment Promotion Agency mediates or handles defense industry exports for local suppliers by dealing with overseas client governments.

**6. Defense Exports Follow-up Logistics Support System**

A system in which the Government provides logistics support, such as defense commodities, faculties and manpower, to client governments to help them operate and maintain the defense items they have procured from local suppliers.

**4. Green Growth and Energy Conservation in National Defense**

**| Green growth in national defense |** The ROK Government declared 'Low-Carbon, Green Growth' as its new national vision and mapped out three major green-growth strategies. To live up to the Government's policy line, the MND has been endeavoring, since June 2009, to meet three major challenges: the development of green technology, a reduction in greenhouse gases, and public awareness-raising about green life.



First, green technology development in national defense is aimed at using eco-friendly and low-carbon energy for the operation of military equipment and facilities. The three major technologies in the initiative are as follows: applied eco-friendly green energy technology; low carbon future energy-based technology; and M&S-based technology for military operations and training systems. Applied eco-friendly green energy technology refers to technologies that produce, store and manage eco-friendly energy, such as photovoltaic energy, for use in field of national defense. The fuel cell for combat vehicles is a prime example of this technology. The technology for a low carbon future energy-based weapons system will transform the current weapon system to one that minimizes carbon emissions and pollution whilst neutralizing enemy combat capability. Its representative example is hybrid electric combat vehicles. The M&S-based (simulation) technology for military operations and training systems has an effect equivalent to real military training while reducing energy consumption to a minimum. Fighter combat simulation technology serves as an example.

Second, the reduction and control of greenhouse gases initiative is being implemented in four areas: establishing and utilizing the Carbon Management Information System for Military Units; replacing the current electric lamps with LED ones; establishing and using renewable energy facilities; and expanding the distribution of low-carbon vehicles, following the Government's announcement of the national objective to reduce greenhouse gas emissions in November 2009. The Carbon Management Information System for Military Units analyzes greenhouse gas emissions and sets a reduction target for each unit to help reduce greenhouse gases. This system is to be applied to the entire military by 2011. By 2013, 30 percent of the electric lamps in the military will be replaced with LED lamps. As for renewable energy generation, a total of 100 facilities are scheduled to be installed by 2015. As for the promotion of low-carbon vehicle utilization, 50 percent of the passenger vehicles used in the military will be replaced with hybrid or compact vehicles by 2013.

Third, the public awareness-raising on green life initiatives aims to let enlisted service members (250,000 per year) spread green awareness which was learned from their stay in barracks while maintaining a green lifestyle,



LED Lamp Installed on an Army GOP Barbed-Wire Fence

after being discharged from service. To that end, lectures of distinguished guests and related professionals will be provided through the national defense PR media, and the commanding officers and staffs of each unit will also educate their service members about green life. To reduce domestic waste, the military is curtailing unpopular menus, applying an incentive system and a self-directed food service system.

In order to encourage the use of bicycles, bicycle racks will be installed within bases and other facilities to promote their use when commuting or moving within a unit. In addition, the effort to acquire bicycles for public use is also being made.

**| Energy conservation |** Energy savings in national defense are being instituted in connection with the Government's energy policies and in consideration of the unique nature of the military. Through a whole-of-government approach, various campaigns are underway: maintaining room temperature at a proper level (for heating, lower than 18°C; for air-conditioning, higher than 28°C), prohibiting the operation of elevators below the fourth floor, the use of bicycles, and non-driving days based on license plates. At the same time, the military is trying to realize daily living habits based on green mind set: an eco-driving campaign for no idling wheels, no abrupt engine stops or starts, water and electricity savings, and the efficient operation of equipment.

Each Service sets its own energy saving objectives, thus reducing the defense budget. The targets are set in three areas in consideration of the price of oil: a combat readiness posture, education and training, and unit operations. In addition, ideas to save energy in daily life without compromising combat strength are continually being explored and publicized. Furthermore, oil-saving training and educational practices, such as the integration of similar training, the use of simulated and scientifically advanced training equipment, and cyber education and video conferences in place of face-to-face meetings are being actively pursued.

**| Creating an eco-friendly green camp |** The MND has realized the concept of eco-friendly green growth across all of its projects ranging from the planning stage as relocating military bases and creating new bases to the construction stage, which involves equipment, facilities, and surrounding environments. For example, during the construction of the naval base on Jeju,<sup>7</sup> all of the following measures will be implemented: use of renewable energy, such as solar and tidal energy; use of eco-friendly vehicles, such as bicycles and electric cars; use of low-carbon heating and cooking facilities, using solar heat and geothermal energy; and implementation of waste recapture engineering methods that use natural-circulation resources.



**7. Naval base, Jeju, (construction to be completed in 2014)**

·Size of Base: 480,000m<sup>2</sup>

·Length of Pier: 1,950m (approximately 20 large vessels can moor at the pier)

# Chapter 9

## Attractive Military, Rewarding Military

**Section 1.** Improving the Welfare of Service Members

**Section 2.** Modernizing the Military Facilities

**Section 3.** Advancing the Military Medical Service System

**Section 4.** Invigorating Productive Military Service Conditions





# Section 1

## Improving the Welfare of Service Members

Military personnel welfare determines the quality of life and morale of service members, and further, it constitutes an integral part of the efforts to maintain intangible combat power. Based on surveys and research pertaining to overall military life, the Ministry of National Defense (MND) has established and carried out military welfare policies that have tangibly enhanced the daily lives of service members.

### 1. Basic Plan for Military Personnel Welfare

According to Article 6 of the Basic Law for Military Personnel Welfare (effective on March 1, 2008), the Minister of the National Defense sets up a Basic Plan for Military Personnel Welfare every five years and finalizes it in consultation with the heads of central government agencies. An effective plan is confirmed after receiving presidential approval.

### 1. Development of the Basic Plan for Military Personnel Welfare

By finalizing the Basic Plan for Military Personnel Welfare<sup>1</sup> (April 21, 2009), following presidential approval, the MND suggested a future vision of military welfare and laid the foundation for systematic and comprehensive welfare policies.

#### Basic Plan for Military Personnel Welfare: Key Points

- **Basic Welfare:** to provide basic living conditions of such quality as to allow service members to concentrate on their military missions.  
\* Improvement in the remuneration system, amendment of the military pension system.
- **Family Welfare:** to alleviate the difficulties facing the family members of military personnel.  
\* Guarantee of academic support for children of military personnel, provision of lifecycle-tailored welfare services.
- **Advanced Cultural Welfare:** to realize a culturally enriched life that matches the development of the society.  
\* Support for self-development, guarantee of all-round conditions where service members can enhance their physical strength.
- **Welfare Infrastructure:** to establish an efficient welfare support system that meets the needs of service members.  
\* Management of amenities, enhancement of welfare fund management efficiency.

**| Basic welfare realization |** Military services feature unique characteristics as follows: first, service members should risk their life in emergencies and national crises in order to defend the nation and protect the lives and properties of its people. Second, since service members should maintain a 24 hour stand-by posture, work mostly in remote areas, and frequently relocate, they often have to compromise the pleasures of family life. Third, career service members, in most cases, retire early at Ages When Expenditure Is the Highest in the Life Cycle (aged between 45 and 56).<sup>2</sup> Fourth, military duty and its associated skills lack similarities with other civilian jobs, which restricts the job opportunities open to former military personnel in society. Considering these points so as to take such disadvantages into account in the policy-making process related to military personnel, the MND has maintained close consultations with the concerned governmental agencies and the National Assembly.

The MND has also refined the military remuneration system so that it now reflects the rank, duties, and working environment of different service members. In addition, the MND aims at increasing the salary of career soldiers to match those being offered by large private enterprises. In 2010, it newly introduced an incentive (KRW 12 million per year) for pilots extending their service period and abolished the restriction on additional pay-rises based on service period<sup>3</sup> to enable a continuous promotion in pay grade until service members retire. As for the pay given to lieutenant colonel-level officers, according to the particular tasks of each position, commanding officers and the heads of departments have been given priority since 2009. Yet, the MND plans to expand the pay in phases to lieutenant colonel-level officers holding a lone position and majors. Aside from these efforts, the MND intends to establish a new benefits system that provides military personnel with service member allowances, family separation allowances, allowances for the college student children of service members and duty service allowances, while also offering allowances for service members working in close contact areas, on-ship service allowances, air service allowances and hazardous duty allowances to ensure realistic compensation for service members in consideration of the danger of their duties and areas in which they are stationed.

The monthly salary for enlisted men, on the basis of a corporal's salary, currently stands at KRW 88,000. The MND plans to set up a realistic pay-level that meets the necessary expenses for their daily activities in and outside the base. In addition, the

### **2. Ages When Expenditure Is the Highest in the Life Cycle**

The age range when expenditure increase to the highest in the life cycle due to child support and other living expenses associated with the relevant stage of life.

### **3. Additional Pay-rises Based on Service Period**

A system that restricts the number of pay-grade promotions to between four and six as a form of additional pay-rises, since the maximum salary of a given rank is reached eight to nine years before the retirement age. The pay-grade of career military personnel increases by one grade every year.

\*The Additional Pay-Rises Restriction System was abolished on January 1, 2010, through the amendment of the relevant law, in accordance with the ruling of the Supreme Court (May 21, 2009).

#### 4. Accident Insurance Service

An insurance service that provides up to KRW 10 million to active duty personnel or switchover service members (conscripted police, combat police, voluntary fire fighters, prison guards working for the Ministry of Justice) in the event of injury or death while they are outside the base, for example on their leave or one-night stay-outs. This insurance automatically becomes effective when they register the *Nara-sarang* card as the account into which their wages are paid.

MND has started providing an allowance for filial visit (KRW 10,000) to enlisted men when they take regular leave. Salary and travel expenses are offered in a lump sum by means of the *Nara-sarang* card issued by the Central Accounting Group, which drastically reduces the workload of each unit. Since March 2010, the accident insurance service<sup>4</sup> has been available for leave, half-day off and one-night stay-outs as an optional and additional service of the *Nara-sarang* [patriotic] card. Aside from such benefits, enlisted students are allowed to defer interest payments while on a student loan, and the exemption from interest payments for those enlisted who are on a student loan is currently being discussed between the MND and concerned governmental agencies.

As part of the tailored welfare system, the MND has been offering hospitalization insurance to children under 20 and spouses of military personnel, since 2010. In the future, the MND will also expand the current online receipt-registration system to minimize the amount of non-used allowance for discretionary use by those who are not able to use electronic cards due to where they are stationed, such as in foreign countries and remote areas.

#### 5. Abolishment of the Mandatory Residence System for Newly Purchased Private Apartments

The Apartment Purchasing System run by each local government, under the Rule of Housing Supply set by the Ministry of Homeland and Maritime Affairs, applies only to local residents who have lived in the city for over two years. The amendment to the rule on September 17, 2009, now stipulates that military personnel can apply for inclusion to the system regardless of how long they have resided in a city.

\* The amendment was made in consideration of the unique characteristics of military service, which leads to relocation of service members every one to two years.

To help long-term service members own a house, the relevant law was amended in 2009, thereby abolishing the two-year mandatory residence system when one wishes to purchase an apartment.<sup>5</sup> Further, it was decided that the supply of public housing sites by the Military Mutual Aid Association would be further expanded as part of its special supply plan. To increase the supply of housing to active duty personnel by up to 50 percent of the total military households, the MND is planning to annually provide 2,000 houses to be offered by the Military Mutual Aid Association by 2012. For this purpose, the MND has mapped out the Seven-Year Plan on Housing Supply. The supply plan by year is shown in Table 9-1.

**Table 9-1. Seven-Year Plan on Housing Supply for the Home-Owning Program of the Military Mutual Aid Association**

Classification	2009	2010	2011	2012	2013	2014	2015
No. of Households	442	2,881	2,635	3,048	2,600	2,600	2,000



From 2010, the MND dramatically increased the home lease fund for long-term service members not living in military quarters. For instance, it has offered an interest-free loan of up to 86% of the total lease and will further increase it to 100% in the future. In addition, for service members working in areas other than where their newly purchased apartment is located, the MND has been discussing with the concerned governmental agencies the possible exclusion of those service members from the Mandatory Residence Period (five years) that applies to buyers of a new apartment through the Government-led *Bogeumjari* [sweet home] program.

**| Enhancement of family welfare |** The challenges facing service members and their family in their daily lives have led to outstanding military personnel retiring early.

To provide well-established welfare support, which helps service members strike a harmonious balance between their workplace and home, and between work and leisure activities, the MND signed the Agreement for Providing Professional Family Support Service<sup>6</sup> to Servicemen’s Family with the Ministry of Health, Welfare and Family Affairs on October 2008. In addition, various programs related to culture and education as well as consulting services are available through the Happiness Support Service for Servicemen’s Families, which links the Local Family Support Centers with concerned local units nationwide. The service program was piloted by 34 units from 2008 to 2009, and it has been expanded to other units since 2010.

In addition, a total of 12 dormitories in ten cities have been provided for approximately 2,200 children separated from their parents while attending schools in various cities. Another dorm that can accommodate 600 students is also planned to be built in Songpa New Town. Career soldiers have long faced the challenge of obtaining quality education for their children as they frequently relocate and often work in small, remote areas, such as eup, myeon, or even smaller villages. Thanks to the Special Admissions System that was introduced in consideration of such educational disadvantages, every year around 450 children of military personnel are admitted to colleges and gain the benefit from the system. In 2010, the MND expanded this benefit to include middle and high school admissions, and it will also offer

Ratio of Home Owners (As of 2008)

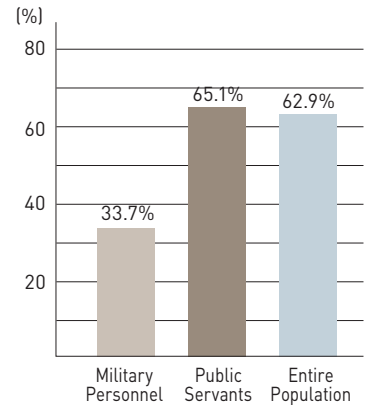

**6. Family Support Service**

A service that helps to prevent family conflicts and improve family relationships by offering counseling services and educational and cultural programs. It also provides customized services, such as baby sitting and day-care services, for two-income families in preparation for emergencies.

Proportional Distribution by Type of Work Location of Career Service Members (As of 2008)

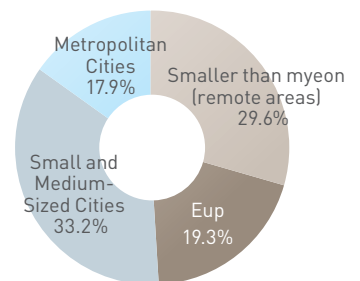

A total of 48.9% of career soldiers work in remote areas that lack basic living infrastructure, including cultural facilities, which demonstrates a large contrast compared to the living conditions of most non-military personnel (public servants: 15.6%, general citizens: 18.5%).



Dormitory for the Children of Military Personnel

**7. Childbirth Encouragement Policy of the MND (applied to multiple-children families)**

- Provision of priority for military housing
- Allocation of large quarters
- Preferred offer of home lease-funds
- Expansion of welfare benefits to cover facilities

college admission workshop tours and college entrance consulting services, while expanding the Special Admissions System to ensure that more children from military families also enjoy this benefit. The Defense Scholarship (Hoguk Scholarship) that has been offered to freshmen and enrolled college students since 1993 was revised in 2010. It is now given to enrolled students only in the form of merit-scholarships, and separate from this, the Armed Forces Welfare Agency offers freshmen cash prizes to congratulate them on their admission to college.

In line with the policies of the National Government, the MND has implemented various policies to encourage childbirth.<sup>7</sup> The MND revised the Veteran’s Pension Act to implement a maternity leave period for childbirth and childcare that counts as part of the regular active service period when calculating one’s severance allowance. In addition, the amended Act allows for the provision of benefits to the replacements of those who are on maternity leave. The MND will also further promote welfare services by continually securing childcare facilities for the children of military families. The plan to secure childcare facilities by year is shown in Table 9-2.

**Table 9-2. The Plan to Secure Childcare Facilities by Year**

Unit: No. of facilities

Classification	2010	2011	2012	2013	2014	2015	2016	Total
Childcare Facility	5	10	23	23	21	2	1	85

**| Support for advanced cultural welfare**

Physical and mental powers is an essential element for uniformed men and women to carry out their duties and missions. Bearing that in mind, the MND has endeavored to provide support for their sporting and cultural needs and leisure activities through which they can recover from the fatigue led by repeated training, working in remote areas, and maintaining a stand-by posture.



Regiment-Level Indoor Gymnasium

Given that military bases are short on standard sporting amenities and fitness equipment, the MND plans to build indoor gymnasiums in every unit at the regiment level and, in the long-term, larger sporting facilities that enable cardiovascular exercises, basketball, volleyball and other popular

sports at the battalion level.

The MND, together with the Ministry of Culture, Sports and Tourism, has offered opportunities to soldiers to relax, recharge and enjoy their daily lives. For instance, art professionals are invited to provide art and cultural education for service members and art companies take tours around units. During the vacations, service members can benefit from discounted services by using the additional services offered by the *Nara-sarang* [patriotic] card, such as for theaters, amusement parks and cultural events.

The MND plans to build a Civilian-Military Integrated Welfare Town<sup>8</sup> in some areas short on welfare infrastructure, including frontlines and islets, in consultation with local governments. To that end, a pilot project will be implemented in one frontline corps by 2012, and depending on the result, this project will be expanded to include other corps.

In addition, to help service members relax and recharge whilst on leave, an agreement to guarantee free admission to private welfare facilities, such as amusement parks and sports stadiums, was made between the military and the concerned amenities. The number of facilities offering free admission to service members is also increasing.

### | Establishment of an efficient welfare infrastructure |

The welfare facilities for each unit have been inefficiently operated due to an overlapping or imbalance in the facilities across the nation. As a result, the preferences of service members were not fully reflected in the welfare management process, which thus failed to offer satisfactory services. Hence, the MND will operate an integrated management system encompassing the welfare facilities to improve their operation, thereby offering balanced welfare services and increasing the satisfaction of the beneficiaries in uniform.

As part of these efforts, the MND built the Armed Forces Welfare Agency in September 2008 and disorganized the respective welfare agencies run by each service in January 2010. The Armed Forces Welfare Agency set up an integrated management system to cover the welfare facilities, while

#### **8. Civilian-Military Integrated Welfare Town**

A welfare town that will be constructed with cooperation between the military and local governments to enhance the welfare and cultural amenities available to local residents and service members stationed in less developed frontline areas.

improving the management each facility according to its type to achieve early stabilization of the system.

To enhance its competitiveness, the Military Mutual Aid Association has realigned its organization and been running the Responsible Management System and Open Competition for Assignments System since 2009. In addition, to improve its balance sheet, it adjusted the member savings interest rate to a realistic level from annual 7 percent to 6.1 percent. The MND has tried to achieve its target housing supply — over 2,000 houses on an annual basis — in order to enable service members to purchase houses; provided two-year maturity installment deposit products besides the current one-year maturity product; and has implemented the Real Name Business System and the Integrity Pledging System.



Green Narae Hotel (Military Resort)

In addition, in order to ensure that service members enjoy sound leisure activities and the opportunity to rest comfortably, the MND plans to renovate its welfare facilities and resorts, while increasing the account numbers allocated to condominiums located in areas that are popular among service members. In the future, integrated welfare facilities containing resorts, condominiums and gymnasiums will be secured to ensure service members can enjoy rest and leisure activities in a single location.

## **2. A Military Pension System Reflecting the Distinctive Characteristics of Military Service**

The Military Pension System contributes to decent living and the enhanced welfare services provided by the MND by directing the benefits to policy holder or their family should a career service member (policy holder) retire after their faithful service period; retire or die due to physical or mental problems; or receive medical treatment due to diseases or injuries inflicted while on duty. In line with the Public Pension Reform of the Government, the MND plans to improve the Military Pension System by reflecting the distinctive characteristics of military service, reviewing the military pension systems in advanced countries, and stabilizing the financial status of the pension system.

### | Characteristics of the military pension system |

During its early stages, the Military Pension System was operated under the Government Employees Pension System (enacted in January 1960). However, since 1963, it has been independently operated in a manner that separates it from the Government Employees Pension System.

The Military Pension System is a form of national compensation and the cost to run the system is considered a security cost. In consideration of such uniqueness, advanced nations have been operating military pension systems separately from their pension fund for government employees. These major countries also provide preferential treatment, over other public pension systems, to the military pension when it comes to minimum service years to be eligible for the pension, the prescribed age at which the initial pension payment can be made, contribution ratio, payment level, and the period of superannuation. The military pension systems by nation are compared in Table 9-3.

**Table 9-3. Comparison of the Military Pension Systems of Major Nations**

Classification	UK	Germany	U.S.	Australia	Indonesia	Italy	France	Korea	
Military Personnel	Retirement Age	55	55-61	40-60	55	53-58	40-60	45-48	45-56
	Age for Initial Pension Payment	55	Retirement Age Reached	Upon Being Discharged	55	Upon Being Discharged	60	Upon Being Discharged	Upon Being Discharged
	Individual Contribution ratio (%)	x	x	x	x	4.75	8.8	7.85	8.5
	Governmental Contribution ratio (%)	Entire Amount	Entire Amount	Entire Amount	Entire Amount	Shortage of Pension N/A	24.2	Shortage of Pension N/A	8.5
Public Servants	Retirement Age	65	60-65	x	x	56-65	60-65	65-70	60
	Age for Initial Pension Payment	60	Retirement Age Reached	60	55	Upon Retirement	60	60	60-65
	Individual Contribution ratio (%)	3.5	x	0.8	2-10	4.75	8.8	7.85	7
	Governmental Contribution ratio (%)	Shortage of Pension N/A	Entire Amount	0.8	Shortage of Pension N/A	Shortage of Pension N/A	24.2	Shortage of Pension N/A	7

\* Revised monthly pay is applied to public servants in accordance with the amended pension law. The individual contribution ratio of 8.5% is equivalent to 5.5% of revised monthly payment.

### | **Efforts to stabilize the financial status of the pension system** |

Due to too many pension recipients at its early stage, the Military Pension System failed to secure the proper level of funding to meet the number of its recipients; this funding shortage has so far been supplemented by the National Government. This shortage in funding can be attributed to the pension being offered without the imposition of superannuation on service members who served in the pre-1959 years, when the current pension system had not been established, and in major combat periods, such as the Korean War and the Vietnam War, which were counted, in service terms, as being three times longer than they actually were. To create an institutional mechanism to stabilize the financial status of the pension system, the MND has amended the Veteran's Pension Act and will continue to improve the relevant institutions.

The MND increased the individual and governmental contribution ratio to 8.5 percent from 3.5 percent. Starting in January 2001, it altered the manner in which to increase the pension from one's salary-based to consumer prices-based, and the calculation of pensions was changed from being based on the last salary to being based on an average of the salary received over the last three years of service. In addition, to ensure the financial stability of the pension fund, a Mandatory Reserve System<sup>9</sup> was legislated. From January 2007, the System has stipulated that in cases where the mandatory reserve is used to pay pensions, the amount appropriated from the mandatory reserve must be replenished within two years.

With the Income Assessment System being implemented in November 2006, the MND has discontinued paying a partial amount of the pension to beneficiaries who have been shown to have extra income besides the pension. The status of pension recipients by year is shown in Table 9-4.

#### **9. Mandatory Reserve System**

A reserve fund that functions to cover any unexpected shortages in the pension fund.

{Article 37, Paragraph 2 of the Veterans' Pension Act}

Table 9-4. The Status of Pension Recipients by Year

Year	Year Recipients (No. of Persons)	Payment (KRW 100 million)	Government- supplemented fund (KRW 100 million)
2005	65,566	16,075	8,564
2006	67,051	16,748	8,755
2007	69,096	18,065	9,536
2008	71,378	19,319	9,492
2009	74,111	20,566	9,409

\* Payment consists of retirement pension, a retirement lump sum payment and retirement allowance.

The Military Pension System is pursuing an increase in fund and profits through the Assets Operation Guidelines.<sup>10</sup> The MND amended the Guidelines in 2008 to increase the target profit rate, while setting up the ‘Risk Management Standard’ to review and manage risks intrinsic to fund management.

In the past those who served for less than 19 years and 6 months were not eligible for a military pension, but from August 2009, with the introduction of the System Interconnecting the Accumulated Periods among Public Pensions, retired service members can also receive pensions through its integration with the national pension.

**| Increase of compensation payment for military personnel sacrificed in the line of duty |** The MND has continued its efforts to strengthen the national responsibility towards service members who sacrificed themselves for the nation. For example, the death benefit standard that was equally applied to death both in the line of general duty and during wartime was reevaluated in 2004 to offer more benefits to those who died in wartime action. In addition, in line with the need to upgrade the compensation for sacrificed service members, the Enforcement Decree of the Military Pension Act was amended in 2010 to increase the minimum benefit amount for those who give their lives, and the Compensation System for Death in the Line of Special Duty was set up for those who perish while carrying out highly dangerous mission at their perils. The details of the amendments are shown in Table 9-5.

#### 10. Assets Operation Guidelines

A document that stipulates the investment policies, investment objectives, investment guidelines and performance evaluation criteria concerning the management of the military pension. These guidelines were mapped out to enhance the stability, transparency and profits generated through fund management. (Article 79 of the National Finance Act)

**Table 9-5. Death Benefits for Service Members Who Died in the Line of Duty (as of 2010)**

Classification	Before Amended	After Amended
Killed in Action	72 times as high as the 10 <sup>th</sup> pay grade at major level (around KRW 200 million): amended in 2004	
Death during General Duty	36 times as high as one's own monthly pay * Minimum: 1 <sup>st</sup> pay grade at staff sergeant level is applied (KRW 36 million-210 million)	36 times as high as one's own monthly pay * Minimum: 18 <sup>th</sup> pay grade at master sergeant level is applied (KRW 90 million-210 million)
Death during Special Duty	Same as Death during General Duty	55 times as high as the 10 <sup>th</sup> pay grade of a major (around KRW 150 million)

**Provision of Internet services** | Starting in May 2006, the MND has made the Military Pension Information System (<http://www.mps.go.kr>) available on the Internet. The System provides up-to-date information regarding the pension and enhances convenience by allowing pension recipients to print out various civil affairs documents, including a letter to verify one's status as a military pension recipient.

### 3. Enhancing Job Opportunities for Retiring Military Personnel

To support job transfer of retiring service members to the social workforce, the MND has made various efforts to expand and discover job positions and to provide customer-centered and tailored vocational education together with other forms of support.

**Expansion and discovery of job opportunities** | The MND secured 12,066 job positions (as of September 30, 2010) that leverage military expertise and experience for discharged long-term service members who have served for over 10 years.

For discharged service members with military-specialized expertise and rich experience, the following job positions were secured: contract military civilian positions, full-time faculty positions in military educational institutions and faculty positions in the security departments and military departments of private colleges. For those who are highly experienced

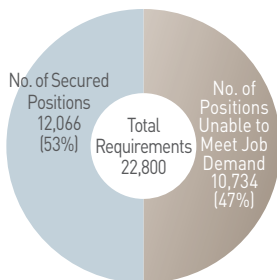

Employment Status of Discharged Long-Term Service Members (as of 2010)



with regards to training, the MND secured supervisor or control instructors of Korea Combat Training Center, reservist ROTC officer positions and teaching positions in specialized high schools. The MND in the future will continue to expand the job opportunities open to veterans in the public and private sectors at the government-wide level, in close cooperation with the concerned governmental agencies and organizations. The employment status of discharged long-term service members (over ten years of service) is shown in Figure 9-1.

Figure 9-1. Job Positions Secured for Discharged Long-Term Service Members (as of 2010)

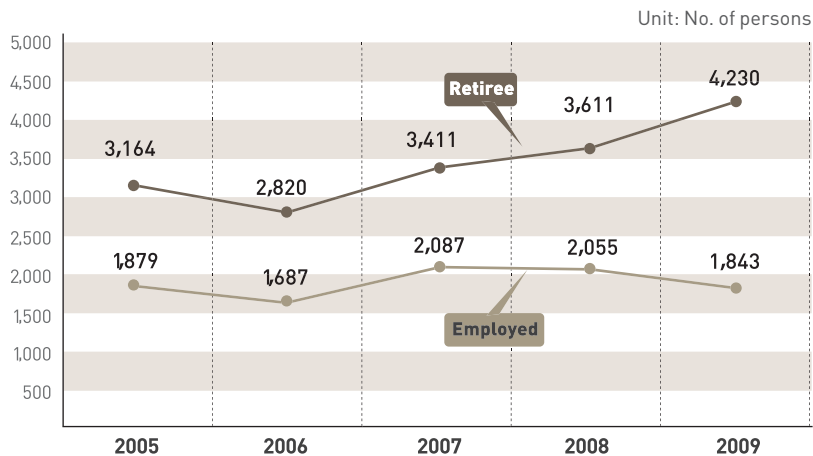

\* Retiree refers to those who have retired within the given year.

\* Employed refers to those who were employed within five years of their retirement.

### | Customer-centered vocational education for job transfer |

The MND has expanded its educational programs in a bid to enhance the competitiveness of retiring officers. It also provides the Tailored Job Transfer Educational Program, in particular, in consultation with the Ministry of Employment and Labor Affairs, the Ministry of Patriots and Veterans Affairs, and the Korea Polytechnics College.

The MND increased the number of its tailored and specialized courses<sup>11</sup> to 20 in 2009 from 12 in 2008. In addition, it will improve the employment rate of discharged service members by diversifying its educational courses based on its annual research on the employment trends of companies and its own customer surveys.

#### 11. Tailored and specialized educational courses (2009)

The job categories specialized by the courses include security instructor, logistics manager, character-building educator, career adviser, building operations manager, housing manager, medical service instructor, judicial scrivener, defense architect, marine officer, computer/internet expert, building automation expert, electrician, gas technician, landscape designer, computers and accounting, online shopping malls, online education for each self-employed business, and small businesses with limited capital. \*Other college-entrusted courses are also available.

The MND has also reinforced the basic educational programs for retiring mid-term officers who have served for five to ten years. For frontline units, itinerant education is being provided and entrusted courses are also being offered by the MND Employment Support Center and the Ministry of Employment and Labor Affairs. Currently, most of the vocational education for job transfer is being conducted by entrusted private institutions. The MND, however, plans to establish and operate its own specialized educational institutions.

**| Development of the job transfer support system |** The MND has developed a Job Transfer Support System, while supporting the employment of retiring officers at the government-wide level, in collaboration with the Ministry of Patriots and Veterans Affairs and the Ministry of Strategy and Finance.

In July 2009, the MND increased the number of job transfer consultants (from two to five) for local Veterans Support Centers, a subsidiary agency of the Ministry of Patriots and Veterans. In 2010, the MND renovated the MND Employment Support Center and, in so doing, made it a larger complex, thereby creating a stable educational environment. The Bonus Point System for Military Service was revived<sup>12</sup> to promote employment opportunities for retiring service members and the amendment of relevant laws is under discussion to ensure better educational options for mid-term officers.

**| Other employment support services |** The MND Employment Support Center, an MND-affiliated agency, has held job fairs every May and promoted the Day of Employment to provide job opportunities and chances to open a new business on a quarterly basis. In addition, the Employment Information System provides online consulting services as well as various types of information concerning job opportunities, new business start-ups and enterprises. The employment support procedure of the Center is shown in Figure 9-2.

#### 12. Opinion Poll about the Bonus Point System for Military Service

Demonstrated that 83% of respondents supported the System (conducted by Korea Gallop, December 2009)



Job Fair for Retiring Officers (April 2009)

Figure 9-2. Employment Support Procedure by the MND Employment Support Center

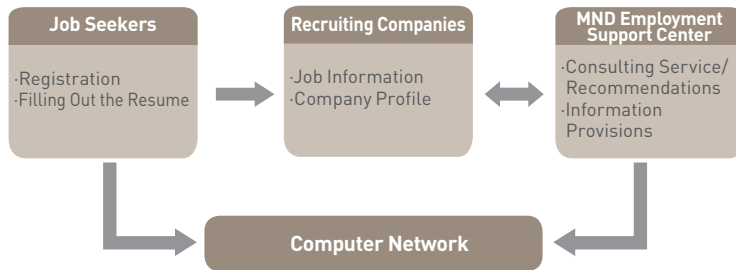

To promote the outstanding abilities of discharged service members, the MND has also offered consultations regarding company policies by inviting the HR managers of different companies, and it has carried out various PR activities through media outlets, including radio and TV programs.

## Section 2

# Modernizing the Military Facilities

The MND has dramatically improved the old and narrow military facilities in line with the enhanced societal living standards and popular expectations for more comfortable living environments. The modernization of the barracks is intended to upgrade service members' quality of life by addressing the discrepancy between the living environment in which new-generation service members grew up and the current living environments in the military. The project to modernize the military residences and bachelor officers quarters (BOQ) was designed to improve residential facilities up to the level of those of civilian residences, thereby creating an environment in which officers can take pride in their occupation. The MND plans to promote the "Attractive Military, Rewarding Military" image of the military by modernizing the military bases, with the completion of this project scheduled for 2012.

### 1. Military Installations Relocation Plan

This plan involves the integration and relocation of units by region, in consideration of the number of soldiers and the resulting demand for unit facilities, in accordance with the National Defense Reform Basic Plan.

### 1. Military Barracks

The modernization of the barracks has been implemented in phases based on the Military Installations Relocation Plan.<sup>1</sup> During Phase 1 (2003-2009), those barracks constructed before 1982, among the old and cramped facilities in the frontline and remote areas, were first improved, and during Phase 2 (2010-2012), barracks built after 1983 will be renovated or increased in size.

Details are as follows: the floor area per person is being increased to 6.3m<sup>2</sup> from 2.3m<sup>2</sup>, while the platoon-sized non-bed barracks are being renovated to bed-filled accommodations for squad sized elements. In addition, amenities, such as computer labs (Cyber Information Center), fitness facilities and common rooms, are being secured, with female-only amenities being separately constructed. The developmental process of the barracks is shown in Figure 9-3.

Figure 9-3. Developmental Process of the Barracks

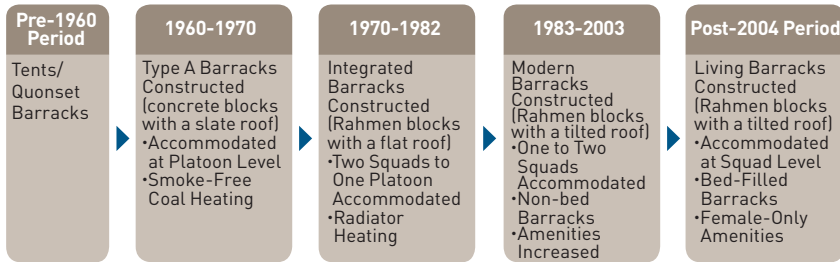

The modernization of the barracks has been implemented by means of Build-Transfer-Lease (BTL)<sup>2</sup> in parallel with governmental investment. From 2003 to 2009, a total of KRW 4.9763 trillion was spent on upgrading 1,975 battalions/living barracks. In 2009, the MND invested KRW 685.7 billion to improve the barracks in 46 Army battalions and 108 barracks for Air Force personnel. From the BTL, KRW 424.2 billion was invested to upgrade the barracks of 51 Army battalions and 14 Navy and Air Force units. By using Other Accounts<sup>3</sup> to enhance defense strength, the barracks of 14 Army battalions were improved. Commenced in 2003 and completed in 2009, some GOP and 275 guard post barracks for sea/river shore units were renovated. In 2010, a total of KRW 1.389 trillion was invested in improving the barracks of 118 Army battalions and 70 Navy and Air Force units. In addition, the modernization project is scheduled for completion in 2012 following the investment of an additional KRW 1.855 trillion. The timeline for the modernization of the barracks is shown in Table 9-6.

### 2. Build-Transfer-Lease (BTL)

The method by which a private business transfers ownership of a business facility that it has constructed to the government, or governmental agency, upon the completion of its construction. The private business recovers the construction cost by being paid rent and management costs by the government.

### 3. Other Accounts

- Improvement of Defense Strength: to improve the military barracks as a key part of the defense enforcement project.
- Donations-Transfers: to give a counterpart a military site (transfer) and receive alternative facilities in return from the counterpart (donation).
- Special Accounts: accounts that consist of the payment made by selling the existing facilities to relocate units.

Table 9-6. Timeline for the Modernization of the Barracks (as of December 2010)

Classification	Completed		In Progress*	Planned		Total
	2003-2008	2009	2010	2011	2012	
Army Barracks (Battalions)	325	111	118	61	51	666
Navy/Air Force Barracks	460	122	70	159	110	921
GOP/Sea and River Shore Guard Post Barracks	682	275	-	-	-	957
Total	1,467	508	188	220	161	2,544
Total Project Cost (unit: KRW 100 million)	38,664	11,099	10,389	8,034	2,821	71,007
Cumulative Improvement Rate (%)	58	77	85	93	100	100

\* The projects initiated or implemented in 2010 will be continuing into 2011.

## 2. Military Accommodations

**| Military residences** | The MND has been improving its old and cramped military residences to match the average level of civilian housing by extending the floor areas to a total of between 80 and 126m<sup>2</sup>. Concerning this plan, the MND intends to refrain from employing the residence provision policies of the past that relied mainly on government funding. Rather, it will utilize both government funds and private investments (BTL), while expanding its financial support plan for apartment-purchasing and home-leases.

In 2009, with KRW 463.7 billion invested, 5,440 military household units were improved, and in 2010, KRW 785.8 billion was spent on upgrading 7,691 household units. To address the issue of increased officer number and shortage of residences, the MND will provide an additional 8,764 household units by 2012. The timeline for military residence improvement is shown in Table 9-7.

Table 9-7. Timeline for the Modernization of Living Quarters (as of December 2010)

Unit: Household

Classification	Completed		In Progress*	Planned		Total
	Pre-2008 Years	2009	2010	2011	2012	
Built	29,671	188	240	178	73	30,350
Purchased	9,895	2,074	-	-	-	11,969
BTL	13,186	1,727	6,910	-	-	21,823
Home-Lease	4,935	356	416	384	367	6,458
Other Accounts	-	1,095	125	71	-	1,291
Total	57,687	5,440	7,691	633	440	71,891
Total Project Cost (unit: KRW 100 million)	44,317	4,637	7,858	407	453	57,672
Cumulative Improvement (%)	80	88	98	99	100	100

\* The projects in progress as of 2010 will be continuing into 2011 (excluding home-leases)

**| Bachelor officers quarters (BOQ)** | The MND plans to secure 111,446 bachelor officers quarters (BOQs) by 2012, in consideration of the possible increase in the number of entry-level officers due to the military restructuring plan. Residence that are 30 or more years old will be renovated to be used as BOQs, and the shortage of BOQs will be addressed through



Yongin Military Residence built through the BTL project

the construction of additional BOQs (up to 2009 the residence that had been renovated were 25 or more years old).

To secure a private space, the BOQs for unmarried officers will be renovated to one-bedroom quarters from the current two-to-three bed quarters, and apartment-type residences will be provided to married officers to ensure the expected level of comfort when their families visit over the weekend.

To improve the BOQs, a total of KRW 355.6 billion was invested, which resulted in 11,357 BOQ units being renovated in 2009. In 2010, a further 21,332 BOQ units were in the process of being secured thanks to an additional investment of KRW 579.8 billion. The timeline for BOQ improvement is shown in Table 9-8.

Table 9-8. Timeline for BOQ Improvement (as of December 2010)

Unit: BOQ unit

Classification	Completed		In Progress*	Planned		Total
	Pre-2008 Years	2009	2010	2011	2012	
Built	56,596	2,581	6,669	1,950	3,225	71,021
BTL	5,623	5,140	9,550			20,313
Renovated	2,351	2,708	4,762	3,232	5,780	18,833
Other Accounts	-	928	351			1,279
Total	64,570	11,357	21,332	5,182	9,005	111,446
Total Project Cost (unit: KRW 100 million)	17,329	3,556	5,978	1,265	3,242	31,370
Cumulative Improvement (%)	58	71	90	95	100	100

\* The projects in progress as of 2010 will be continuing into 2011 (excluding home-leases)



Apartment-type BOQ for married officers



Stand-alone type BOQ for unmarried officers

# Section 3

## Advancing the Military Medical Service System

The MND has modernized the Military Medical Service System to provide more advanced care of the health to service members and to ensure their combat capabilities. The MND has focused its reinforcement efforts on eight major areas, including manpower, equipment and the facilities of clinics at the division level, in accordance with the Mid- and Long-term Comprehensive Plan for Development of the Military Medical Service that was established in July 2008. In addition, the Framework Act on Military Personnel Welfare provides the legal basis to guarantee the basic right of individual service members to proper medical treatment.

### 1. Reinforcing the Military Hospital System

To reinforce the Military Hospital System, the MND has endeavored to improve the diagnosis/medical treatment of patients; adjusting the roles and functions of military hospitals through the ‘selection and concentration’ policy; enhancing the medical support capacity.

To sharpen diagnosis accuracy, state-of-the art medical equipment, including three MRI and three CT scanners were introduced to military hospitals between 2008 and 2010, and currently, a total of 15 MRI and 18 CT scanners are available for use. To bolster the existing military hospital facilities, the MND built Hampyeong Hospital, Pohang Hospital, the Maritime Medical Center and the Korea Army Training Center District Hospital, whilst the remodeling of the Armed Forces Capital Hospital and Byeokje Hospital is in progress. In addition, the MND provides medical treatment allowances to medical officers in order to secure a stable medical officer workforce and promote their willingness to work. In February 2008, the MND signed an agreement with Seoul National University Hospital. The timeline for the employment of civilian contracted doctors,<sup>1</sup> following this agreement, is shown in Table 9-9.

#### 1. Civilian Contracted Doctor

The system in place for the hiring of medical specialists, with doctorate degrees, as contracted doctors in order to complement the shortage of medical personnel within the military and to provide high quality medical services.



Surgery being conducted by civilian contracted doctors



**Table 9-9. Timeline for the Employment of Civilian Contracted Doctors (as of November 2010)**

Unit: No. of persons

Classification	Internal Medicine	Surgery	Orthopedic Surgery	Neurosurgery	Anesthesiology	Pathology	Ophthalmology	Emergency Medicine	Others	Total
2008		1	1		1	1			1	5
2009	4	1		1	1		1	1	1	10
2010	2		3	2	2			2	2	13
Total	6	2	4	3	4	1	1	3	4	28



Medical Evacuation Helicopter

The MND plans to adjust the roles and functions of 20 military hospitals dispersed across the entire military, thereby reducing the number to 15 by 2020. According to this plan, Masan Hospital was dissolved in 2009 and the scope of services offered by Gyeryongdae District Hospital was reduced to be incorporated into the Gyeryongdae Service Support Corps.

To improve the capacity to evacuate patients during wartime and peacetime and to ensure close medical support with rapid mobility, medical evacuation helicopters and deployable medical systems will be introduced. The deployable medical systems<sup>2</sup> will be used for overseas operations and during peacetime training exercises as well as for medical support by mobile corps during wartime.

## 2. Reinforcement of the Manpower, Equipment and Facilities of Clinics at the Division Level

The MND has reinforced the manpower, equipment and facilities of its division-level clinics – those most used by service members - to strengthen the primary medical support capacity.

To create a pleasant environment for medical treatment, the MND has upgraded the medical facilities at the division level and reinforced the necessary diagnostic and examination equipment, such as digital X-rays panoramic dental radiographic systems and automatic bio-chemical analyzers. In addition, between 2008 and 2009, the MND procured and deployed 362 new model ambulances equipped with a cooler/heater and first aid equipment for field units. Furthermore, licensed nurses, dental hygienists, physical therapists and emergency medical technician were also organized as medical non-commissions officers. The plan to improve

### 2. Deployable Medical System

A container or tent type medical facility that enables rapid deployment and removal. This facility can be easily loaded onto vehicles and enables the provision of close medical support for combat units while ensuring rapid mobility and deployment.



Deployable Medical System

the medical facilities at the division level is shown in Table 9-10.

**Table 9-10. Plan for Improving the Medical Facilities at the Division Level**

Unit: No. of units

Classification	Completed (as of 2009)	2009-2010	2010-2011	After 2012	Total
Army	6	6	5	8	25
Navy	14		2		16
Air Force	7	1	2	4	14
Total	27	7	9	12	55

The MND supplied 36 patient transportation buses to frontline divisions to ensure service members' convenient access to medical facilities. It also reinforced the Medical Support Units in two divisions to bring them in line with those at battalion level, while increasing the number of medical treatment categories from five to between eight and nine.

# Invigorating Productive Military Service Conditions

Today, the social consciousness about military service is changing. In the past, military service was mainly considered a noble duty pertaining solely to national defense alone, but it is now also considered a period during which service members can develop the skills needed for their future economic activities. Bearing this in mind, the MND has ensured the basic rights of officers and enlisted men by improving their working conditions and has taken the lead in creating a new barracks environment typified by its scientific accident prevention measures in consideration of the characteristics of the new generation service members. In addition, the MND has enhanced individual, military and national competitiveness by encouraging its service members to undertake life-long education to further develop their economic capabilities; MND supports programs for academic credit-earning during the service period, qualification examination (equivalent to general equivalency diploma (GED)) application, and 'One Service Member, One Qualification,' which means that all officers and employees are encouraged to acquire one qualification each.

## 1. Ensuring the Basic Rights of Service Members and Improving Working Conditions

The MND has developed organizations and systems to ensure the basic rights of service members. As part of its efforts in this respect, Human Rights Division, which oversees the basic rights policies and their assurance, was newly established within the MND in January 2006. The Human Rights Sections that were organized under the Headquarters of each Service in December 2007 are responsible for monitoring the implementation of the basic rights policies in each unit under their command. The MND revised the Regulation on Military Human Rights Education in January 2008 and broadened the range of human rights education for service members working in human rights-related areas in 2009, such as medical services, investigation, correction, judicial affairs and unit instructor jobs. In addition, it complemented the grievance-related institutions to allow enlisted men to file grievances based on which the Directive on Unit Management was amended. In February 2010, the MND mapped out human rights guidelines to raise awareness in commanding officers about human rights and, on June 14, 2010, established the



Counseling session with a professional counselor for soldiers

Basic Plan of Defense Human Rights Policy, a blueprint of the MND human rights policies, and distributed it to each Service .

The MND has run the Professional Counselor for Soldiers System. Professional counselors for soldiers consist of qualified civilian experts specializing in counseling or psychology. They provide counseling services to maladjusted service members to military service in the bases and professional advice, based on the finding from the consulting, to commanding officers about how to address the issues facing the service men under their command. The System was piloted for two years from 2005 to 2006 and it is currently being implemented across the entire military. The Army has deployed professional counselors in 38 units at the Division and Brigade level, the Korea Army Training Center, Drafting Review Management Corps, and Life (Consulting) Phone; the Navy has the system in the Operation Command, each command of a fleet, each Division of marine corps, and the Training Group; and the Air Force has deployed counselors in the Operations Command, the Logistics Command, and the Training Command. From 2011 onward, the System will continue in consideration of its efficiency.

The MND has enhanced the sense of autonomy of service members in their military lives by introducing the self-organized scheduling practice. In addition, the MND has endeavored to create a voluntary-based service environment as well as conditions where enlisted men are allowed to manage their after-duty time as they please.

## **2. Expanding the Support for the Self-development of Service Members**

The ROK military produces 240,000 active duty enlisted personnel and 17,000 officers every year. Accordingly, the MND supports service members to develop productive skills while faithfully carrying out their duties as military personnel, thereby making their stay in the military productive and being able to adapt to society after being discharged.

**| Capacity-building of service members |** Recently enlisted men see military service not only as a duty related to national defense but as a chance for them to take off to achieve a new life. With over 83% of the total enlisted men being college students, today, service members in general tend to show a strong interest

in self-development. Bearing that in mind, the MND has supported the academic credit-earning program, application and preparation for qualification examinations and the program 'One Service Member, One Qualification.' In addition, it also has actively strengthened the cooperation among industrial, academic and military institutions, with respect to fostering technical professionals.

**| Credit earning during the military service period |** To provide a supportive and educationally primed environment for service members, a total of 53,000 personal computers were installed to establish Cyber Knowledge Network Rooms in units, including up to squadron level units and units located in small or remote areas. In addition, the MND is gradually increasing the number of universities that offer distance academic courses for service members to 50 in 2010, from 41 in 2009, with the plan to expand the number to 90 after 2015.

In this supportive environment, service members can acquire three credits per semester and six per year. To relieve the financial burden of tuition fees, the MND, in collaboration with the Ministry of Education, Science and Technology, introduced a student loan system named '*Narajikimi*' that offers loans of up to KRW 90,000 to 600,000 per semester for individuals.

**| Support for qualification examinations |** Around 6,000 men every year join the military without having received a high school diploma or even a lower-level diploma. To motivate them to develop themselves and to enhance their will to work in the military, learning conditions tailored to such individuals have been in the process of improvement since 2009. For instance, study rooms are now available in each unit and mentors are designated from among qualified personnel who can support the learning process. In addition, the Cyber Knowledge Network Rooms provide educational contents and resources. The number of those who passed a qualification examination for the high school diploma increased to 1,000 in 2010 from 600 in 2009, and the MND intends to continue this effort more actively by linking this support with the lifelong learning policy.

**| One service member, one qualification |** In 2009, the MND implemented the 'One Service Member, One Qualification' policy to help service members acquire specialized occupational skills in preparation for future jobs. The MND targets over 60 percent of the total discharged service members to have one



A service member taking a distance learning course



Performance test of the MND-entrusted National Vocational Qualification Exam

or more specialized licenses advantageously applicable to the job market from the end of 2010, while setting a target of 100 percent from the end of 2012. To this end, the MND has expanded the military educational courses that allow the course-takers to be exempted from the written test in the National Vocational Qualification (NVQ) exams when they take the exam. It has also been increasing the number of state-authorized civilian certification tests that offer a discounted exam fee to service members.

Since 2010, the MND has been developing the Korean Skill Standard (KSS) in order that the specialized skills acquired during military service be recognized as national certificates; at present, the KSS development of three categories, deep-sea diving, helicopter maintenance and aviation equipment maintenance, has been completed, and these three areas are now in the process of being developed into national certificates.

### **| Fostering technical professionals through concerted efforts among industrial, academic and military institutes |**

To ensure a regular supply of military technical professionals, the MND has selected military-specialized students from ten vocational high schools across the nation. Those chosen by the MND will be trained for one year through practicum courses focusing on military equipment operation and maintenance, and they join the military as technical personnel responsible for managing specialized technical areas or maintaining advanced equipment. In 2010, the foundation to enable them to take bachelor's degree courses in their specialized areas was set up and these courses will be available from March 2011.

Under this system, the actual jobs they conduct in their main specialized areas during the service period will be counted as practicum credits, and by taking online and offline classes, they will receive a bachelor's degree.

At the same time, in cooperation with the Ministry of Employment and Labor and the Small and Medium Business Administration, the MND is proactively planning to establish an employment support system for these technical personnel by 2011 in consideration of the time when they are discharged. This system that fosters and utilizes outstanding technical personnel resources has been highly evaluated as a flagship example that results in a win-win situation for individuals, the military and the nation.



On-the-job training for military specialized high school students in preparation for joining the military.

### 3. Establishing the Scientific Accident Prevention System

Various human accidents that occur in the military not only reduce its combat strength but are also the biggest possible cause of public mistrust of the military. Hence, the MND has systemized scientific methods and procedures to prevent accidents and implemented a prevention system by considering the characteristics of the new generation service members.

In late 2009, the MND began developing and operating new and highly reliable personality test instruments designed in consideration of the characteristics of the new generation service members. Now, the military is able to precisely identify those with mental illnesses and maladjusted service members to military service, and it has also computerized the handling of the relevant data to efficiently take care of those who need special care.

The MND also developed diagnostic inspection instruments for military personnel stress and a scientific educational program to prevent suicide that matches the characteristics of the military. The instruments and the educational program were applied across the entire military following their pilot application at the end of 2008. And since July 2009, the Integrated Suicide Prevention System<sup>1</sup> has been in operation. Through this scientific accident management system, the MND has been collecting various accident case data and accident prevention information in an integrated manner, which contributes to accident prevention.

The MND also launched the Enlistment Interdiction and Early Separation System, which enables a systematic management of those who are considered inadequate for active duty positions (throughout all stages from drafting to actual duty servicing). At the drafting stage, those candidates not fit for military service are identified and not allowed to join the military. At the boot camp training stage, the Active-Duty Service Eligibility Review System is run to ensure a timely handling of the inadequate candidates. During the actual service period, the military determines those who are not adequate for their assigned military positions. In addition, the relevant laws have been amended to allow inadequate personnel to be transferred to replacement positions (e.g., public service personnel) or be discharged, if necessary.

Should a service member perished in an unfortunate accident, the MND sends a death notification to the home of the service member to directly notify the fact of his/her death to the bereaved family.

#### 1. Integrated Suicide Prevention System

An integrated system that uses scientifically based 'identification-management-screening' methods to prevent suicide within the military.



Ceremony for 60<sup>th</sup> Anniversary of Seoul Recapture  
and 62<sup>nd</sup> ROK Armed Forces Day  
(Gwanghwamun, Sep 2010)





# Chapter 10

## The Armed Forces Serving the People

- Section 1.** Enhancing Public Benefit and Protecting Public Rights
- Section 2.** Efficient Relocation of Military Installations
- Section 3.** National Defense Policy That Goes Together With the People

# Section 1

## Enhancing Public Benefit and Protecting Public Rights

Maintaining a firm all-directional military readiness posture, the ROK military extends efforts to support the people whenever necessary. At the same time, it strives to realize 'National Defense that Serves the People' by easing the regulations on the Military Installation Protection Zones, operating eco-friendly military forces, and establishing a nationwide disaster readiness posture.

### 1. Easing of the Regulations on the Military Installation Protection Zones

The Ministry of National Defense (MND) continues to ease the regulations on the Military Installation Protection Zones to the extent that military operations will not be disturbed. On September 22, 2008, the Act on Protection of Military Bases and Installations came into effect, integrating three separate pieces of legislation that had been applied by each of the three services within the military: the Military Installations Protection Act, the Naval Bases Act, and the Military Air Bases Act. This Act ensures rights of civilians with regards to their property and resolves the inconveniences stemming from the use of land by the military.

In the past, in consultations regarding construction and land use within the reservation zones, the operational review standards differed depending on the unit in question and the commanders, which was problematic because it gave rise to differences in consultation results even for identical requests. To

Lifting or Easing of the Military Protection Zones (Unit: m<sup>2</sup>)

Classification	Lifted	Eased
2009	12,810,000	189,000
2010	25,220,000	2,670,000

resolve this issue, the operational review standards were unified, and since March 2010, they have been reflected in the Directive on the Management of Military Bases and the Military Facility Protection Zones and implemented accordingly. The main contents of the operational review standards are as follows.

First, operational zones that are within 25km of the Military Demarcation Line (MDL) were divided into 'zones that must be protected' and 'other zones' in order to ensure conditions for carrying out military operations. To minimize control over the protection zones by the military, civilians will be allowed to develop the land in the 'zones that must be protected' if the military's defensive strength is not weakened by such development. As for 'other zones,' the regulations pertaining to the existing protection zones have been relaxed as much as is feasible or they have been entrusted to the local governments.

Second, as for the areas beyond 25km of the MDL, the standards applied to the protection zones near military bases have been eased even further within the scope of the current laws. As shown in Figure 10-1, in the past, protection zones were designated by calculating the distance from 'the most outward fence' in the unit; this has been adjusted so that the distance is calculated from the 'core facility' within the unit, thereby reducing the area of military protection zones.

Figure 10-1. Adjustment of the Military Facility Protection Zones (March 2010)

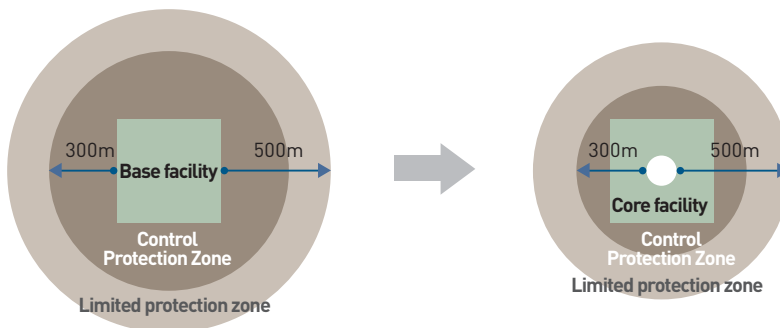

Third, the operational review standards no longer take into account whether the military installations are visible from the developed area and newly constructed buildings, nor do they limit the height or direction of the structures near the units based on the reason that activities within the unit will be exposed.

Fourth, deliberations on military installations are now fairer and more transparent. When the Military Facility Protection Review Committee is held, the local government or the interested parties are given the opportunity to explain the related matters prior to the deliberations if they so demand. The results of the deliberations are also notified in detail to help concerned parties easily understand them.

The MND has designated for entrustment a 140 million m<sup>2</sup> area of land,<sup>1</sup> which is five times the area of Yeouido, scattered over 21 cities and counties, so that private owners can exercise property rights, such as the construction of buildings within the protection zones, without having to consult the military, and the MND plans to continue to expand this entrusted area. The Standards and Procedures for the Assessment of Aviation Safety Impact was established in January 2010 so that the characteristics of each military airfield would be considered when limiting the heights of buildings in flight safety zones. In the future, the Standards and Procedures will apply to all military air bases, and they are currently being implemented in the regulations of each service.

The MND plans to increasingly ease the regulations on the Military Installation Protection Zones to the extent that military operations are not impeded. This will ensure that citizens can exercise their property rights and utilize land efficiently.

## **2. Eco-Friendly Military Management**

The environment is an important factor in determining the quality of life. In the 21<sup>st</sup> century, we must strike a balance between environment protection and economic and social development. Additionally, the government's strong policy aimed towards 'Low-Carbon Green Growth' is imperative in assuring

### **1. Entrusted area**

An area designated by the military unit with jurisdiction such that when a person builds new structures or engages in other development activities, the local government can deal with the matter directly without having to engage in administrative consultations with the respective military unit.

the survival and prosperity of future generations.

In line with these current needs, the MND is pushing forward with several projects: developing the military environment management system; expanding projects to prevent environmental pollution; engaging in environmental conservation activities; establishing airfield and shooting range noise prevention measures; and managing the environment in returned USFK bases. In addition, it has applied the low-carbon green growth concept to its operating military units, serving as a pattern for energy-reduced, low-carbon management.

### | Developing military environment management system |

The MND is reinforcing the environmental organization within the military and developing an educational and training system to strengthen the expertise of those personnel specializing in environmental issues. First of all, it has established environmental management groups and organizational standards that are appropriate in light of the characteristics of each Service and the units thereunder, and has been securing experts in the relevant areas. In June 2007, two Environment Battalions were established, followed by the establishment of two companies dedicated to environmental issues in December 2009. These units support the initial action to be taken in the event of environmental accidents and also support the environmental clean-up of USFK bases that have been returned.

The MND has entrusted the environmental management education of the troops of the units dedicated to environmental issues to specialized institutions that also tour the military units twice a year to give environmental training to the relevant personnel of each unit. All military schools also have classes on environmental issues to instill an eco-friendly mindset in the service members.

The MND carries out its environmental work by establishing a mutual support and coordination system with the Ministry of Environment. Twice a year, since 1998, the MND and the Ministry of Environment have together held the ‘Central Military and Government Environment Council,’ and local unit commanders and local environmental agencies have held the ‘Military



Practical on-site training during an environmental educational tour of the military (May 2009)

and Government Environment Council.’ In addition, the MND and the Ministry of Environment jointly make biannual instructional visits to the military units and assess their environmental management status and uncover matters for improvement.

Since 2010, a regularized consultative body comprised of military environment authorities has been holding meetings every month to strengthen the expertise of the personnel dedicated to environmental issues within the military and to build a close cooperative system among the military's environmental departments, thus resolving major issues.

### **| Expanding projects to prevent environmental pollution |**

The ROK military operates environmental facilities in accordance with the environmental laws and regulations and improves dilapidated facilities.

As of the end of 2009, the ROK military was operating 6,573 environmental basic facilities, such as water pollution prevention facilities. Projects are being expanded toward treating the domestic sewage from military units by connecting the sewage pipelines to the public sewerage treatment plants run by the local governments. It has also strengthened the preventive measures regarding water pollution by outsourcing the operation and management of the military units' sewage disposal to specialist companies.

To satisfy the strict standards on the quality of discharged water as provided under the Sewerage Act, amended in September 2007, the ROK military has first of all upgraded the wastewater facilities that have daily capacity of 50 tons or more and is planning the phased upgrade of other facilities by the year 2011. The status of the efforts to secure and upgrade the military's basic environmental facilities is shown in Table 10-1.

Table 10-1. Status of the Efforts to Secure and Upgrade Basic Environmental Facilities

Units: number of establishments

Classification		Total number required	2009 (%)	2010	11-15 yr Mid-Term Plan
Secured	Water Pollution Prevention Facilities	4,457	4,280(96)	42	135
	Soil Pollution Prevention Facilities	3,707	2,083(56)	195	1,429
	Air Pollution Prevention, Noise Prevention, and Incineration Facilities	233	210(90)	2	21
	Total	8,397	6,573(78)	239	1,585
Upgraded	Water Pollution Prevention Facilities	1,180	189(16)	191	800
	Contaminated Soil Remediation	271	138(51)	36	97
	Hazardous Work Sites	382	166(44)	10	206
	Total	1,833	493(27)	237	1,103

With respect to the protection of the soil, emphasis is placed on preventing the occurrence of pollution. Automated oil leak detectors are being installed in underground oil storage facilities. With respect to the aboveground oil storage facilities, concrete dikes are being installed to prevent oil leakages should the storage tanks be damaged. Oil pipelines are also being installed aboveground in order to reduce the possibility of oil leaks underground and to enable leaks to be verified immediately upon occurrence. Furthermore, the soil surrounding the oil storage facilities is periodically investigated, and once soil contamination is detected, remediation work is carried out for the area.

The waste ammunition in shooting ranges is collected periodically and facilities preventing the spread of contamination are constructed. The waste ammunition in shooting ranges is retrieved by either the service members of the relevant unit or handled by companies to which the work has been outsourced. The surrounding area of the shooting ranges is investigated on a regular basis, and contamination prevention measures are established if needed. Depending on the topography of the area near the shooting range, the spread of contamination is prevented by installing water detention ponds, regulating reservoirs or dams, which have the effect of improving the water quality, growing plants that are effective in removing contaminants from the soil, or appropriately managing the wetlands where wild reeds grow on their own.



Storage of Collected Ammunition



Regulating Reservoir Dam

The MND is actively enforcing the lawful disposal, reduction and recycling of the military's waste. The handling of the daily trash produced by the military is outsourced to local governments and private waste treatment entities, and only in those areas, such as islets, where outsourcing is not possible, the military handles its own waste by installing military incineration facilities and food treatment equipment. Designated waste and construction wastes that can pollute the environment, such as waste oil and waste acid, are treated by specialized waste treatment companies. The status of military waste treatment is shown in Table 10-2.

Table 10-2. Status of Military Waste Treatment (as of 2009)

Unit: Ton

Classification	Amount of waste	Amount treated		
		Recycled [%] (including outsourced and self-treated waste)	Disposal	
			Outsourced	Self-treated by the military
Daily trash	98,847	24,897(25.2)	73,153	797
Food waste	35,641	34,627(97.2)	692	322
Designated waste	12,499	7,779(62.2)	4,720	-
Construction waste	394,015	381,434(96.8)	12,581	-
Total	541,002	448,737(82.9)	91,146	1,119



Han River cleanup efforts by the Army Special Warfare Command service members (September 2009)

**Engaging in environmental conservation activities** | The ROK military supports environmental conservation activities in various ways by participating in the government-wide National Land Grand Cleaning Campaign. For example, the military has initiated the New Spring National Grand Cleaning Campaign and the One Mountain and One Stream Care Campaign, while supporting the Han River cleanup, joining the environmental conservation activities in remote islets, and retrieving waste from flooded areas. The number of participants and major results of these environmental conservation activities are shown in Table 10-3.



Table 10-3. Status of Environmental Purification Activities

Classification	Environmental conservation activities			Civil/Government/Military cooperative support	
	Number of activities	Number of participants	Waste retrieved (tons)	Number of activities	Number of participants
2008	10,580	918,555	8,464	1,079	117,398
2009	12,823	765,116	7,674	1,031	99,497

In addition, an average of over 50,000 service members per year participate in activities to conserve the ecosystem by feeding wild animals during the winter and retrieving poaching tools, such as snares and traps. The status of these activities to protect wildlife is shown in Table 10-4.

Table 10-4. Status of Activities to Protect Wildlife

Classification	Retrieval of tools			Feeding (ton)
	Snares/Traps (pcs)	Agricultural chemicals bottles (pcs)	Snake nets (m)	
2008	1,533	549	1,717	2,253
2009	1,549	287	437	1,818

**| Preventing noise from airbases and shooting ranges |** Due to the territorial circumstances evident in the Republic of Korea, military airbases and shooting ranges are situated in locations that are not too far from residential areas and, therefore, local residents often suffer from noise pollution. To resolve this issue, the MND is seeking to establish noise reduction measures, secure noise prevention facilities, and introduce the Act on Noise Prevention at Military Airbases and Support of Areas Requiring Noise Control Measures.

Efforts have been exerted toward reducing noise by adjusting the air routes and altitudes of aircraft during take-off and landing and minimizing the number of late-night flights. To reduce the noise from shooting ranges, the shooting hours and the location of firearms have been adjusted and nighttime shooting has been restricted. In addition to these efforts, noise prevention facilities have been secured, including the soundproofing maintenance shops (Hush Houses) in airfields as well as soundproof walls and noise buffer forests.



Inside View of a Soundproof Maintenance Shop

To support those residents who suffered from noise pollution, the MND has also been promoting the enactment of the Act on Noise Prevention at Military Airbases and Support of Areas Requiring Noise Control Measures. This proposed act was submitted to the National Assembly in 2009 after undergoing the requisite procedures, such as consultations among the relevant departments and agencies and preliminary announcement of the legislation, and is currently being deliberated on by the National Assembly. Its main concerns include the following: should the effect of the noise on areas near the military airfields and shooting ranges be at or above a certain level, the area will be designated and announced as a Noise Countermeasure Area; noise prevention projects will then be implemented in the Countermeasure Areas; and mid-term plans for noise countermeasure projects will be established every five years. The law includes provisions obligating the military to install noise measuring instruments in military airfields and shooting ranges, to measure the noise level constantly, and to reduce noise during military training. If the proposed law is passed by the National Assembly, noise impact assessments will be made regarding military airbases and shooting ranges and noise countermeasures will be taken by investing a certain amount of the budget on the annual basis.

### **| Managing the environment in returned USFK bases |**

The bases that were used by the USFK in the past are being returned pursuant to the ROK-U.S. Land Partnership Plan (LPP), the Yongsan Relocation Plan (YRP) and the Status of Forces Agreement (SOFA). Of the 80 targeted bases that are due to be returned, 47 were handed over as of January 2010. The returned USFK bases are passed down to local governments once the necessary procedures have been carried out, such as the examination of the facilities inside the returned bases; establishing a plan for managing the returned base; reporting to the National Assembly; clean-up of pollution; and tearing down facilities.

Of the returned bases, 29 have been found to require environmental remediation in accordance with domestic environmental laws. The MND plans to openly promote remediation projects pertaining to returned USFK bases while coordinating with the relevant local governments regarding the

remediation goals, which depend on the use of the base after its return, and the methods of the investigation and remediation for the surrounding area of the returned base.

### **3. Establishing a Readiness Posture against National Disasters**

#### **| Reinforcing disaster readiness and support capabilities |**

Recently there have been frequent outbreaks of new epidemics, and a growing trend in the occurrence of large-scale typhoons, downpours, snowstorms and other natural disasters due to climate change, which have resulted in an increasing number of requests for military support of prevention and restoration efforts. The MND, as a 'Military of the People,' has established the principle to prioritize providing support to civilians before restoring damage within the military and then tends to the restoration of damage within the military. Under this principle, it has been making diverse efforts toward resolving the difficulties faced by people during the early stages of a national disaster.

First, it has been strengthening its cooperative ties with relevant agencies. In November 2007, it designated, in advance, the support units for each local government, and 197 units have signed a 'Memorandum of Implementation of Particulars' with 248 local governments. In December 2007, it signed an agreement with the Ministry of Land, Transport and Maritime Affairs (MLTM) and the Korea Coast Guard regarding search and rescue efforts following aircraft accidents. In May 2009, it signed an agreement with the MLTM for joint use of disaster- related video transmission systems.

Second, it has been modifying disaster management manuals, thereby preparing for various types of disasters. In 2008, it supplemented the practical manuals, in connection with the standard crisis management manual of the government, for each of the 20 types of disasters, such as storms and floods, earthquakes and wildfires, and in 2009 modified the on-site action manual that is being used in the event of a disaster.

Third, it has been putting more importance of education in disaster management. It offers lectures and seminars given by invited experts to commanders, service members and disaster-related officials and provides educational tours on damage recovery procedures for personnel responsible for disaster management and damage recovery. Recently, the MND has been providing education for users of the government-wide disaster management network to ensure swift communication of the situation and information sharing following a disaster.



Preparing to mobilize container vehicles (Defense Transportation Command, June 2009)

Fourth, it has been securing sufficient military technical personnel to prepare for functional paralysis of the nation's core infrastructure. In the event of an unlawful strike by the subway labor union, technical personnel who have been trained in the relevant areas are sent to protect the national infrastructure and to minimize the inconvenience experienced by citizens. Beginning in 2010, over 500 additional technical personnel in areas of rail, power generation, and gas have been trained, and through consultations with the relevant agency, the military's technical personnel that are dispatched upon a strike will have the benefit of casualty insurance.



The Send-Off Ceremony for the Overseas Emergency Relief Unit to Help Haiti Recover from the Earthquake (January 2010)

Fifth, the MND has built a system that enables the immediate support of the government-led humanitarian relief activities in the event of an overseas disaster. When a large-scale overseas disaster occurs, the government organizes and mobilizes an overseas emergency relief team centered on international rescue teams, medical support teams and the Korean International Cooperation Agency, while providing aid in terms of relief funds and relief supplies. The MND has incorporated the task manual and other relevant contents in the enforcement ordinance, which is the Act on Overseas Emergency Support, which were amended at the undertaking of the Ministry of Foreign Affairs and Trade (MOFAT) for the purpose of supporting the Government. It also published a task manual for the military transport aircraft used in the government's emergency relief activities for overseas disasters. This manual establishes the organic, cooperative procedures in relation to the relevant domestic and foreign organizations, such as the emergency

response guidelines for immediate mobilizations, the measures to be taken at each stage, and the reference materials for various task, thereby building an emergency support system.

Lastly, the MND and each Service are responsible for organizing and managing disaster rescue teams in order to implement these policies and various other measures and put highest priority on acquisition of the supplies and equipment needed for rescuing people. Furthermore, standards pertaining to having in place disaster management supplies and equipment have been provided in consideration of the type of disaster and the characteristics of each military unit. The supplies and equipment have been secured and managed with the cooperation of the relevant local governments.

### | Supporting emergency rescues and disaster recovery

| The MND maintains a 24-hour emergency rescue support and a disaster readiness posture by operating 35 disaster search and rescue units and 412 Disaster Situation Offices. The procedure for providing support to civilians in the event of a disaster is shown in Figure 10-2.



Supporting snowfall damage recovery (Dangjin, Chungnam, January 2009)

Figure 10-2. Procedure for Civilian Support in the Event of a Disaster

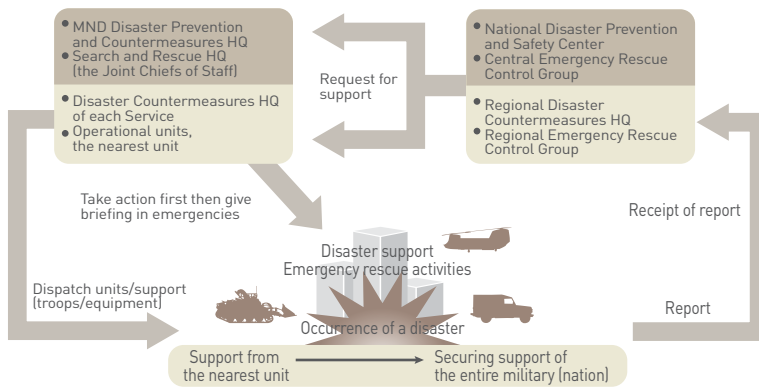

The major disaster recovery support activities, domestic and overseas, supported by the military over the past five years are as follows: damage recovery from a wildfire in the Yeongdong area and heavy snowfall in the Honam area in 2005; damage recovery from a landslide in the Philippines and an earthquake in Indonesia in 2006; damage recovery from Typhoon ‘Nari’ and involvement in the efforts to prevent the spread of oil in Taean in 2007; preventive as well as burial efforts in response to avian influenza and involvement in the recovery efforts in response to the earthquake in Szechuan, China, in 2008; and support of damage relief efforts connected with droughts, wildfires, Swine flu and the Cambodia typhoon in 2009. The results of emergency rescue and disaster recovery activities over the last five years are shown in Table 10-5.

**Table 10-5. Results of the Emergency Rescue and Disaster Recovery Efforts**

Classification	Support		Recovery performance						Major content
	Troops (1000 persons)	Equipment (pcs)	Human rescue (persons)	Organization of residences (bldg)	Farmland (ha)	Road/Dike (km)	Greenhouse/Stable (bldg)	Quarantine/Disinfection (ha)	
2005	214	5,590	10	1,182	3,980	2,192	9,737	25	• Sand/waste removal: 14,428 tons
2006	337	13,833	1	2,019	245	395	3,934	170	• Fumigation/removal of pine trees: 4,777 • Overseas disaster relief airlifts: twice, 14.5 tons
2007	182	2,607	182	4,296	945	7	4,252	53	• Salvage of fishing boats: 16 boats • Extinguishing wildfires: 26.4ha
2008	188	3,286	11	295	7	34	370	27	• Slaughter of avian influenza-infected animals: 1,890,000 • Szechuan earthquake: 26.6 tons * Provision of daily necessities and air transport
2009	157	4,201	6	260	72	18	537	-	• Quarantining H1A1: 8,972,000 persons • Cambodia typhoon damage: 7 tons * Transport of relief supplies • Provision of water during droughts: 7,597 tons
Total	1,078	29,517	210	8,052	5,249	2,646	18,830	275	

### | Future direction of defense disaster management |

The MND, as a responsible agency for disaster management, as well as the supporting agency for emergency rescues, is making every possible effort to minimize potential threats to life and damage to property. In order to prepare for the ever diversifying and increasing in scale disasters, defense disaster management capabilities must be further strengthened and civil/governmental/military entities must cooperate closely with one another.

With this awareness, the MND has secured the personnel required to take exclusive control of military disaster management and the yearly budget and has been developing its capabilities focused not merely on efficient use, response and recovery of resources but also prevention, through the cooperation of the civil, governmental and military sectors. The ‘disaster and safety management’ budget, which was drawn up in 2007, has increased every year, and in 2010, approximately KRW 2.6 billion was used toward acquiring and maintaining disaster management equipment and supplies as well as preventive construction and repair work. In 2015, the MND plans to secure at least KRW 7 billion.

In light of the current situation, which has seen a frequent occurrence of transnational disasters, the MND is making efforts toward government-wide domestic and overseas emergency activities by cooperating with the relevant Ministries and agencies. The MND and the military have built an international cooperation and military support structure for the government's efforts toward emergency relief should a large-scale disaster occur overseas. By actively participating in such efforts, the nation's image and status will be enhanced in the international community.

## 4. Strengthening Civil Support in Agricultural Areas

The MND offers active civil support by leveraging its available personnel, equipment, and skills to the maximum extent possible without impeding the performance of its basic duties.

During the farming season, the MND provides manpower for transplanting and harvesting in the farms situated in regions suffering from a lack of

Disaster and Safety Management Budget Trends (Unit: KRW 100 million)

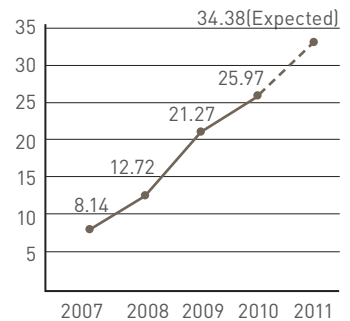

Support to overcome a drought (Jeongseon, Gangwon-do, January 2009)



Support to make rice stalks stand upright (Pocheon, Gyeonggi-do, July 2009)

farm hands. It also provides support in terms of personnel and equipment to upgrade the agricultural infrastructure related to structural changes in the rural villages by maintaining waterways and improving rivers. It has also organized the ‘Agro-machinery Rotating Servicing Teams’ to provide repairs on agricultural equipment in areas without agricultural equipment service centers.

As part of the Love the Rural Village Campaign, the MND has conducted a ‘One Unit One Village Sisterhood Campaign’ to assist in farm work, such as harvesting potatoes and picking apples. The results of the assistance given to farms and fishing villages over the past five years are shown in Table 10-6.

**Table 10-6. Results of the Assistance Given to Farms and Fishing Villages**

Classification	Support personnel (no. of persons)	Support equipment (pcs)	Major support activities			
			Farming support (km <sup>2</sup> )	Agricultural machine repairs (pcs)	Waterway repairs (km)	Others (no. of persons)
2005	155,466	2,556	24.6	2,365	76	8,083
2006	146,794	3,089	46.7	7,278	176	11,335
2007	180,103	2,800	18.6	4,491	820	10,660
2008	107,849	1,785	188.5	1,727	31	6,740
2009	98,074	2,453	34.1	1,126	41	24,916
Total	688,286	12,683	312.5	16,987	1,144	61,734

\* Others: medical/quarantine support, providing drinking water, cleaning up the environment, and other volunteer work.



# Efficient Relocation of Military Installations

The MND intends to relocate the land for military use, which takes up 1.2 percent of the ROK's entire territory, by the year 2020, and thereby contributes to the efficient operation of units and regional development. The financial resources needed for such relocation will be obtained to the greatest extent possible from the surplus land for military use that will come into being in the process of relocation. Thus, the burden on the defense budget would be reduced.

## 1. Planning the Relocation of Military Installations

At the end of 2009, the MND established and has been putting into practice its plan to decrease the number of military installations. The plan entails a reduction from the current 1,900 to 700 by the year 2020 when the restructuring of the military will be completed in accordance with the defense reform. The key map for relocation of military installations is shown in Figure 10-3.

Figure 10-3. Key Map for Relocation of Military Installations

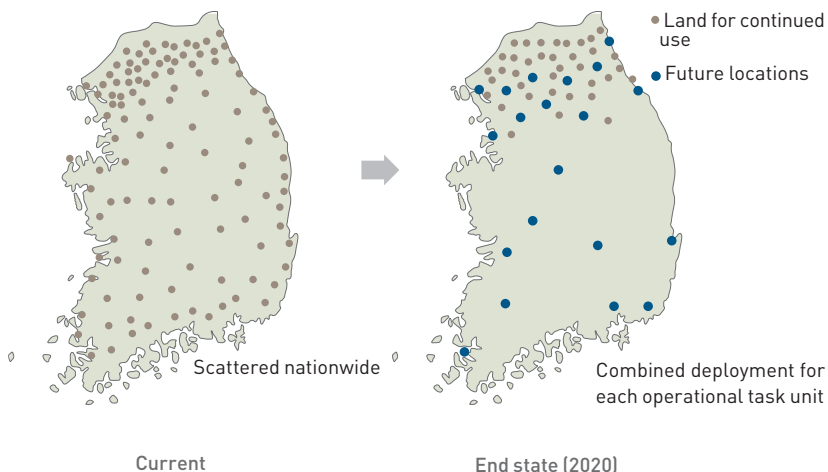

**| Backdrop to and standards for establishing the relocation plan** | The relocation plan was established in consideration of many background factors. First, a large number of troops and units will be removed following the restructuring of the military from its current quantitative, conventional form centered on troops to a qualitative, high-tech military force structure that is information and technology-intensive. Second, the existing scattered military installations are now considered to interfere with urban development of nearby cities as cities are growing and expanding, which has resulted in conflicts with the residents. Third, the existing military installations are small in scale and disperse in order to secure the ability for immediate response and survivability at each post, but due to the advances in the early warning system and the introduction of the unmanned security system, it becomes possible to combine military installations on a large scale.

In consideration of these internal and external environmental changes, in 2009 the MND has established a military installation relocation plan reflecting the amended draft of Defense Reform Basic Plan. The focal points of the plan are as follows: the units located downtown at the time of the establishment of the relocation plan will be moved to the outskirts if possible, the existing land for military use will be used to the greatest extent possible so as to minimize having to purchase new land, and local governments' urban planning will be referenced to predict and manage potential conflicting factors.

**| Implementing the relocation program** | The relocation program will take place in phases and be timed in link with military restructuring. Training facilities will be combined and installed by categorizing them into function, thereby decreasing the requirement for lands and security. Training facilities, such as military training grounds, will be shared by scheduling the times when each unit can use the facilities to increase efficiency.

By 2020, when the relocation of military installations is complete, the currently small-scale and scattered military installations will be combined into large-scale installations, and their efficient management will be possible by combining the facilities and functions within the installations. Those located downtown will be moved to the outskirts; the military relocation programs will reflect urban planning, and military amenities will be opened to local residents in underdeveloped areas.

The relocation program of military installations is a long-term plan that requires a massive amount of financial resources. Using national resources means that citizens will have to bear the burden, so in order to minimize this burden, the MND will use the financial resources derived from adjusting the land for military use, and cautiously apply them to purchasing land and constructing facilities.

## 2. Efficient Use of Land for Military Use

**| Status of land for military use |** Land for military use refers to the land that is a state property<sup>1</sup> that the MND manages for the purpose of carrying out military operations and for the stable stationing of units. Land for military use amounted to approximately 1,205km<sup>2</sup> as of November 30, 2010, and comprised 1.2 percent of the total area of the ROK (5.0 percent of state property). The status of land for military use is shown in Table 10-7. The status of land for military use per region and type of land is shown in Figure 10-4.

### 1. State properties

All properties owned by the state to carry out administrative tasks (broad meaning) and properties that have been nationalized at the state's expense, by donation of the land to the state, or by laws or treaties (narrow meaning).

Table 10-7. Status of Land for Military Use (as of November 30, 2010)

Area of ROK territory (km <sup>2</sup> )	Total state property		Land for military use	
	Area (km <sup>2</sup> )	Compared to the total ROK territory (%)	Area (km <sup>2</sup> )	Compared to the total ROK territory (%)
100,210	23,895	23.8	1,205	1.2 [5.0% of state property]

Figure 10-4. Status of Land for Military Use Per Region and Type of Land (as of November 30, 2010)

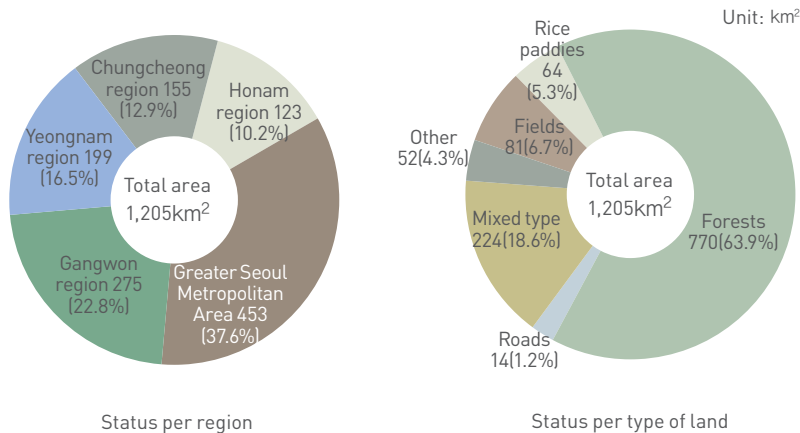

**| Efficient use of land for military use |** The ROK military promotes efficient use of the land for military use, in consideration of balanced development of the land and urban planning in the regions, as long as it does not impede military operations.

According to the Defense Reform Basic Plan, many units have been moved or relocated, and with the return of a total of 178km<sup>2</sup> of USFK bases, in accordance with the Yongsan Relocation Plan (YRP) and the Land Partnership Plan (LPP), there has been an increased need to raise the management and land use efficiency by the military. Consequently, the MND has set the direction for the efficient use by the military in a way that best benefits the state, the local government and the citizens, as opposed to just managing the land for military use as in the past, so far as military operations are not impeded.

In January 2008, the MND signed an MOU on Cooperation for Efficient Management of Land for Military Use with the Korea National Housing Corporation, the Korea Land Corporation and the Korea Appraisal Board and is actively introducing the advanced management techniques used by the private sector.

In addition, it is clearing out the private land currently being used by the military in order to ensure the property rights of citizens and is seeking ways to promote the use of the land for military use.

# National Defense Policy That Goes Together With the People

The MND actively promotes policies that are directly related to and help the daily lives of the people, such as improving the military service and conscription systems. The MND also attempts in various ways to better communicate with the public by sharing information and strengthening public relations (PR). In particular, with the advent of the 60th anniversary of the Korean War, it has been widening its bond of sympathy with the people through re-enactments of battles, extension of invitations to foreign war veterans to Korea, and cultural, sporting events and other various programs.

## 1. Improving the Military Service and Conscription Systems

The MND has been working to improve the military service and conscription systems to contribute to the upgrading of the military's combat capabilities and to promote equality and efficiency in the performance of military service. Major areas of improvement include shortening the service period, introducing paid volunteer system, improving the alternative service system, and promoting the community service system.

**| Shortening the military service period |** The military service period is being gradually shortened in order to resolve the problem of the surplus in military personnel due to the reduction of troops, to alleviate the burden of compulsory military service on citizens, and to allow men to enter society earlier and therefore engage longer in economic activities. The shortened period per type of service is shown in Table 10-8.

**Table 10-8. Shortened Period by Type of Service**

Applicable to	Current	Shortened to
Army, Marine Corps, combat and conscripted police, security personnel in correctional facilities, full-time reservists	24 months	18 months
Navy, Marine combat police, Conscripted firefighters	26 months	20 months
Air Force	27 months	21 months

Over a projected period of eight years and seven months (January 2006 to July 2014), the service period will continue to be gradually shortened. The method for shortening the military service period is shown in Figure 10-5.

**Figure 10-5. Method for Shortening the Military Service Period**



However, the shortening of the service period is being reviewed because, following the shortening of the military service period, proficiency and expertise of the troops have fallen. Military combat capabilities have thus been more difficult to maintain and problems in supply and demand of military service resources are expected to arise.

**| Implementation of the paid volunteer system |** Shortening the military service period has the positive effect of resolving the problem of surplus military resources caused by the reduction in troops and relieving the burden on citizens. However, it can lead to a decline in military combat capabilities due to a lack of skilled service members, which results from their rapid turnover rate. In order to prevent the deterioration of military combat capabilities following the shortening of the service period and to efficiently use national human resources, the MND introduced and implemented the paid volunteer system<sup>1</sup> in January 2008.

The basic operating policy of the paid volunteer system is as follows. First,

**1. Paid volunteer system**

A system where active duty personnel or other applicants may apply and serve for an extended period of time and receive a prescribed salary.

during the conscripted service period, they are paid and managed in the same manner as the enlisted men. Second, during the extended period they are promoted to staff sergeants and receive the treatment due a noncommissioned officer together with the appropriate level of salary in consideration of their level of skills and expertise.

Combat or skilled soldiers (Type I ) are selected from experienced enlisted service members and serve as staff sergeants for a six to 18 month period once they have completed their conscription. State-of-the-art-equipment operating specialized soldiers (Type II ) are selected from civilian resources prior to their conscription and serve for three years from when they first enlist. They serve as enlisted service men during the conscription period and as staff sergeants during the remaining period. The status of the paid volunteer system per type is shown in Table 10-9.

Table 10-9. Status of the paid volunteer system per type

Classification	Selected by	Service period	Service area	Salary
Type 1 (skilled soldiers)	Chief of Staff of each Service	6-18 months of additional service	Posts related to combat and technical skills (squad leader, radar, etc.)	KRW 1.2 million per month
Type 2 (specialized soldiers)	Commissioner of the Office of Military Manpower Administration	Three years of service	Posts related to state-of-the-art equipment operations (next-generation tank (XK-2), KDX-III, etc.)	KRW 1.2 million (incentive pay of KRW 600,000 per month not included)

The pilot operations, which have been carried out since 2008, found that paid volunteers are useful immediately upon commission and contribute to the management of units with their diverse experience. This system is therefore useful in developing the military into a technology-intensive structure centered on high-tech combat capabilities. However, the original goal of recruiting 40,000 members by the year 2020 has been determined as difficult to achieve because of the public's sense of burden regarding the extended service period and the insufficient compensation. Therefore, mindful of the possibility of achievement as well as cost-effectiveness, the MND has readjusted its goal downward to 16,000 service members.

## **2. Alternative service system**

A system that allows for the efficient use of surplus military manpower after active duty service positions have been filled. Under this system, the excess personnel may serve in a national capacity comparable to active military service.

## **3. Switchover service personnel**

Active duty personnel whose statuses have been changed so they can serve as conscripted combat police, personnel in correctional facilities or security personnel in correctional facilities, etc.

## **| Operation of the switchover service and alternative service systems<sup>2</sup> |**

Switchover service personnel<sup>3</sup> have contributed to securing national security power, but it has been decided that the switchover service system will be reduced and then abolished because of the increase in the discontent of the service members and the scientific systemization of security facilities. Under this decision, the MND will reduce the number of switchover service personnel by 20 percent each year until 2011 and will abolish the system in 2012. Combat and conscripted police members will be maintained from 2010 to 2011 at the same level as in 2009 to secure public safety, but the assignment to this service will be abolished in 2012.

Meanwhile, although alternative service personnel have contributed to the provision of services to citizens and the development of national industries, there have been some equality issues pertaining to the fulfillment of military services and efficient use of human resources. In order to improve this, the MND is phasing out alternative services, such as skilled industry personnel. Of the skilled industry personnel, 4,500 will be annually assigned to active duty services until 2011 while replacement personnel will be reduced every year by 20 percent until 2012, when the assignment will cease. The timing of the reduction and abolishment of the switchover service personnel and alternative service personnel will be reviewed and carried out after a comprehensive consideration of the supply and demand forecasts regarding military personnel resources.

In addition, improvements were made to the alternative services provided by the public service personnel, skilled industry personnel and specialized research personnel to enable efficient use of human resources. The split service system was introduced to allow public service personnel to treat an illness or tend to their household affairs by allowing them to defer service for a certain period and to return to serve their remaining time. Furthermore, it allowed public service personnel to serve as skilled industrial personnel if they wished to be employed in order to financially support their household. The minimum service time required before transferring posts, as applicable to specialized research personnel serving in national research institutes and university/corporate research institutes, has been shortened from 24 months to 18 months. The choice of institutions to serve in has been broadened in order to promote efficiency in the use of human resources.



**| Promoting the community service system |** The MND has been promoting the community service system<sup>4</sup> to supplement the above-mentioned problems of the alternative service system and to respond to the increasing demand for community services.<sup>5</sup> In the public service area, the MND has gradually reduced simple administrative assistance work and expanded the community assignments that were found to be in demand. The major details of the community service system are as follows.

First, the system seeks to promote equality regarding the military service by adjusting the current conscription standards so that individuals with partial physical limitations are assigned community services if they are capable of social activities.

Second, the system seeks to promote efficient use of human resources by adjusting the public service personnel's areas of service and committing them primarily to work in areas that require manpower but is experiencing hardship finding it, such as providing assistance to the disabled or the elderly.

Third, to reinforce the community service personnel's sense of responsibility and expertise the MND offers cultural and functional education. Through such education, the alternative service personnel will be able to meet society's demands and will have more pride in their military service.

## 2. Improving Military Manpower Administration

The MND has been improving various systems to prevent individuals evading their military service and has been creating a climate conducive to the faithful fulfillment of the military service. Besides, to improve the accuracy of the physical examinations it has provided precise examination systems and has improved the civic services for the candidates for the military service.

**| Countermeasures against military service evaders |** The MND established the Comprehensive Measures for Preventing Military Service Evading<sup>6</sup> to fundamentally prevent individuals from avoiding their compulsory military service. It has been promoting the amendment of related laws to enable the verification of physical examinations for those suspected of attempting to evade military service.

### 4. Community Service System

A system allowing men to serve in community service areas instead of on active duty.

### 5. Community services

The services provided by a society to improve an individual's and the community's welfare. They include services in the areas of social welfare, public health, education and culture, and environmental safety.



Drafting examination (Seoul Regional Military Manpower Administration, February 2010)

### 6. Military service evading

Acts such as deliberately imposing physical injury on oneself, deferring enlistment based on fake illnesses, and deferring enlistment dates falsely in order to be exempted from or be allowed a reduced period of military service.

First, to prevent and efficiently respond to the ever more intelligent and diverse ways of military service evading, the MND has provided the Measures for Preventing Military Service Evading Crimes, which include the items regarding the operation of the Military Service Evading Prevention and Investigation Team. In the future, it will continue to enhance fairness and equality regarding the fulfillment of the military service by adjusting various systems to prevent the crime of military service evading, such as improving the enlistment deferral system.

Second, the MND is pushing forward an amendment to the Military Service Act that would mainly extend the physical reexamination period (from one to two years) in order to increase the accuracy of the reexaminations of those whose physical ratings have been unconfirmed (Level 7).

**| Providing a precise examination system |** To ensure fair judgment regarding military service, the MND has built a precise examination system with the acquisition of high-tech equipment and by assigning more examination personnel. It has appointed outside medical experts as ‘military conscription judgment ombudsman’ to collect complaints, grievances and views regarding matters for improvement of the system and has strengthened its surveillance and control functions.

For precise physical examinations, it has reinforced its expert personnel and secured high-tech medical equipment as needed. In 2009, it brought in additional AIDS (Acquired Immune Deficiency Syndrome) virus testing equipment (one in 2006, nine in 2008, five in 2009; a total of fifteen have been secured) and carries out AIDS testing on all examinees in the drafting examination. Examinations regarding rare and incurable diseases are outsourced to civilian medical institutions.

**| Creating a climate conducive to faithfully fulfilling the military service |** The MND has been carrying out diverse policies to create a climate conducive to the faithful fulfillment of the military service.

It has stably operated a system for disclosure regarding the military service of public officials ranked level 4 or above, thus enhancing the transparency

and confidence in military service fulfillments as well as satisfying the people's right to know. However, to protect personal information, the Military Service numbers of those who have fulfilled their military duties have been excluded from disclosure by an amendment to the Act on the Notice and Disclosure of the Military Service Matters Related to Public Officials. Military Service numbers are personal information that can be used as PIN numbers for bank accounts and Internet sites. Hence, the Act was amended to prevent illicit use of such information.

In addition, the MND began the Program to Promote Families Renowned for Outstanding Military Service in 2004 to instill greater pride in those persons who have faithfully fulfilled their defense-related duties and to express respect for their sacrifice and devotion. A family renowned for its outstanding military service is selected from families that have had three generations in active duty. In 2010, a total of 192 families were selected.

**| Improving the convenience of military service members in their duties** | The MND has improved its civic services processing system regarding military manpower administration and has eased the rules and regulations applied to the candidates for military duty, thereby increasing their convenience.

First, it abolished the Overseas Travel Departure Declaration System. In July 2008, as overseas travel by candidates for military service increased, a system was formed between the Office of Military Manpower Administration and the Ministry of Justice to share data related to the permission for overseas travel and the step of departure checks was eliminated to minimize the inconvenience experienced by these travelers. Thereafter, the Military Service Act was amended and the departure check system was completely abolished (December 10, 2009). Consequently, around 60,000 annual civil petitions and grievances regarding departure checks have been resolved and the workload reduced.

Second, in 2010, it introduced and implemented the enlistment and drafting date deferral system for the candidates of military service who are already employed after graduating from vocational schools. If a person wishes, he can defer enlistment or drafting until the age of 24.

Third, the recruiting system of active duty members has been improved. In the past, if a person recruited for active duty was unable to enlist on the specified date, recruitment was cancelled, but in 2009, the enlistment date deferral system was introduced, which made it possible to adjust the enlistment date within a three-month period from the original enlistment date. The status of enlistment date adjustments (deferrals) is shown in Table 10-10.

Table 10-10. Status of Enlistment Date Adjustments (deferrals) (as of 2009)

Classification	Recruited service members	Adjustment (deferral)	Ratio
No. of persons	130,329	1,494	1.1%

### 3. Expanding Communication with the Public

The MND has been making various efforts, such as sharing more information, strengthening PR using many types of media such as the Defense Media Agency and new media, and engaging in various cultural activities in order to raise the satisfaction level regarding its civic services and to satisfy the public's right to know.

**| Improving civil services** | The number of civil petitions related to defense has been steadily declining since 2006, and around 3,200 to 4,000 cases are received per month. The number of civil petitions received is shown in Figure 10-6.

Figure 10-6. Number of Civil Petitions Received

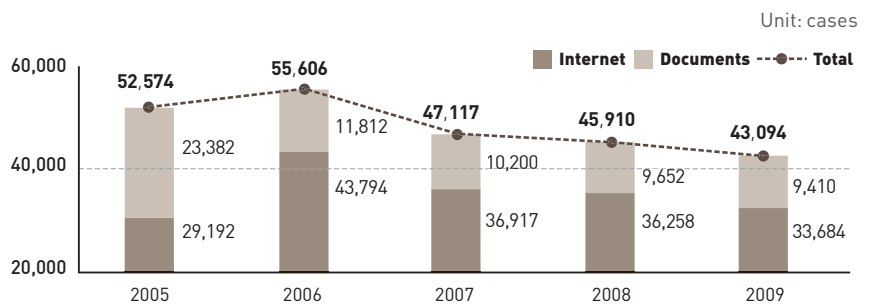

According to a survey on the level of satisfaction regarding the civil services, carried out by the Korea Public Administration Research Institute at the behest of the Prime Minister's Office, the MND was selected as an outstanding organization for two consecutive years in 2008 and 2009. Due to its characteristics, defense related civil petitions are difficult to resolve in many cases as they require large-scale budgets or have operational restrictions, so the fact that the satisfaction level for its civil petitions services has risen is appraised as being the result of active efforts of the MND. The trends in the satisfaction level for defense related civil petition services are shown in Figure 10-7.

Figure 10-7. Trends in Satisfaction Level for Defense-Related Civil Services

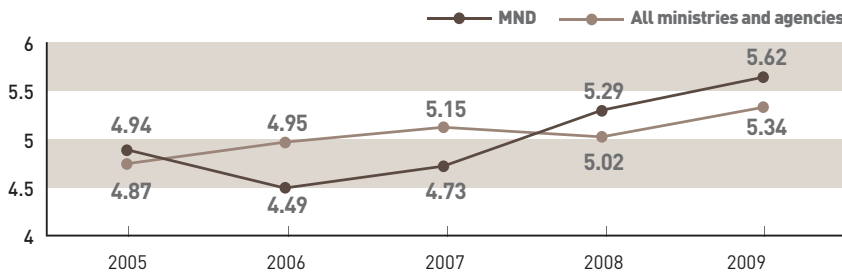

\* On a scale of 0 to 7, the level of satisfaction regarding defense related civil services has been steadily increasing above the average for all of the ministries and agencies since 2008.

With the public's increased desire to know more about the nation's defense policies, there have been more requests for information disclosure. The status of requests for information disclosure over the past five years is shown in Table 10-11.

Table 10-11. Status of Requests for Information Disclosure Per Year

Unit: cases

Year	2005	2006	2007	2008	2009
Number of requests	492	468	677	748	641

In 2006, the institutional foundation for information disclosure was provided by amending the guidelines for the 'Instruction to Disclose Defense Administration Related Information,' setting forth the main information produced in the process of the performance of duties and listing the types of

information that can be obtained prior to a request for information disclosure and also details the scope of information that is to remain undisclosed under Article 9 of the Information Disclosure Act. These are supplemented in a timely manner when major existing policies are changed or the department in charge is changed. In addition, to enhance the competence of the persons responsible for information disclosure practical training is offered every year to those in charge. Outstanding cases are shared with the entire organization and the person who performed the work is awarded based on an assessment of the operation of information disclosure tasks by defense-related agencies.

The MND has improved the information disclosure menu on its website and has changed the method of providing information lists, among other improvements made on the operation system, to make it easier and more convenient for the public to access information. Thus, in advance, the MND makes public those matters that interest the public, such as the start-of-the-year defense briefing and easing of regulations, thereby reinforcing communication with the public. It also provides the public, with the requested information within the designated period through prior notice of the handling period.



Recording a KFN program

**| Public relations through the Defense Media Agency |** The MND conveys national defense policies to the public through the Korea Forces Network (KFN) TV and Radio, the Korea Defense Daily and the Defense Journal under the Defense Media Agency, which is operated as an affiliated responsible agency.

KFN TV delivers military news to service members and citizens through satellite TV and local cable broadcasting. KFN Radio focuses on daily life in the military and national defense policies in an easy-to-understand way through a popular publicity supporting crew and provides general cultural and entertainment programs. In particular, its entertaining train shows contribute greatly to boosting the morale of service members working in remote areas.

The Korea Defense Daily, with a circulation of 150,000 copies daily, and the Defense Journal, with a circulation of 20,000 copies per month, provide various military information. The Korea Defense Daily has now changed from its previous broadsheet format to a smaller tabloid-style format for which it has been getting positive response from its readers.

**| Policy PR using the new media |** The MND also engages in online PR activity, in line with the so-called Web 2.0 era. The MND has improved its website interface to be more user-friendly and communicates with netizens on its lead blog ‘Donggodonglak (<http://mnd9090.tistory.com>).’ In 2009, it consecutively opened a themed blog site for its career soldiers called ‘Captain Park, Permanent (maldduk) 3rd year’ and a policy blog called the ‘Passionate Defense (yeolhyeolgukbang)’ that specializes in introducing national defense policies. ‘Donggodonglak’ was chosen as the best public service sector blog in 2009 at the Blog Award Ceremony organized by the Korea Blog Industry Association, and in April 2010, the number of visitors to the site passed the five million threshold, setting a new milestone in Internet PR within the public sector.

In 2010, the MFN actively pursued PR using social network services (SNS), such as Twitter and me2day, in addition to blogs, thereby gaining various channels of direct communication with the public without having to go through the existing mass media, such as broadcasting or newspapers. The MFN can thus explain national defense policies directly to the public and avoid any distortion of the facts that may result from indirect conveyances by the mass media. In addition, it is able to receive the diverse opinions of the public as real-time feedback. In addition, the policy customer service,<sup>7</sup> which has been implemented since 2003, is being improved continuously.

**| Expanding various cultural activities |** The MND holds various cultural events in June, the Month of Patriots and Veterans, and on October 1, the Armed Forces Day. In 2009, in commemoration of the 61<sup>st</sup> Armed Forces Day, over 30 photos by military photo specialists and over 80 photos held by the Army, Navy, Air Force, Marine Corps and the Defense Media Agency were exhibited at the War Memorial of Korea for a two week period, drawing over 30,000 visitors. In April 2010, the ‘Exhibition of Photos of Korean Soldiers Overseas’ was held in COEX and seen by 60,000 visitors.

In 2010, commemorating the 60<sup>th</sup> year since the outbreak of the Korean War, the MND together with ten leading Korean photographers held the photo exhibition ‘On the Line,’ a Korean War Special Photo Exhibition, in Daelim Contemporary Art Museum. The same exhibition was also held in the United Kingdom and the United States, which recorded the highest number of

#### 7. Policy customer service (PCRM: Policy Customer Relationship Management)

Obtaining the understanding and support of previously registered policy customers, regarding defense policies, by sending PR mail and gathering opinion.



The poster for the special photo exhibition ‘On the Line’ in memory of the Korean War

casualties of the 16 participating nations in the Korean War.

In January 2010, the Armed Forces Symphony Orchestra was launched from its parent, the Armed Forces Band, which primarily featured wind and percussion instruments, by recruiting string instrument majors. The Armed Forces Symphony Orchestra held the 60<sup>th</sup> Anniversary of the Korean War Commemoration Concert and is going to participate in cultural exchange events with foreign armed forces.



The 60<sup>th</sup> Anniversary Emblem of the Korean War

#### 4. The 60<sup>th</sup> Anniversary of the Korean War Project

**| Establishment of the task force for the 60<sup>th</sup> anniversary of the Korean War project** | 2010 marks an important year where the ROK, once a nation in ruins due to the sudden attacks by the North, swells with pride as a nation to host the G20 Summit. The MND sought to express its respect for the dedication of the ROK and foreign Korean War veterans who made it possible for the ROK to gain this prosperity; in addition, it sought to raise the nation's image as a nation that contributes to world peace and prosperity and in turn raise the nation's prestige. For this purpose, the ROK government formed the 'the 60<sup>th</sup> Anniversary of the Korean War Commemoration Committee' to push forward with the initiative at a government-wide level.

The MND, in cooperation with the government, actively assisted in the activities of governmental agencies, such as the Korean War Commemoration Ceremony, the Armed Forces Day Event commemorating the 60<sup>th</sup> Anniversary of the Korean War and the Recapture of Seoul, the Grand March for Peace and Unification, and the Peace Camp for Youth from Participant Nations in the Korean War. In addition, it has engaged in various events and activities by establishing the 'Korean War 60<sup>th</sup> Anniversary Office, MND' and placing a project team in each service for the purpose of instilling a sense of national security, thanking and honoring the ROK and foreign veterans of the Korean War, and increasing cooperative security relationships by reinforcing the ties with nations that fought in the Korean War.

**| Projects carried out by the MND** | The MND has carried out 13 projects (19 sub-programs), in commemoration of the 60<sup>th</sup> Anniversary of the



Korean War, under the following three themes: ‘Memory and Legacy,’ ‘Honor and Gratitude,’ and ‘Harmony and Cooperation.’

‘Memory and Legacy’ seeks to convey the reality of the Korean War and the meaning of the veterans' sacrifice to the post-war generations to enable them to perpetuate their noble spirit. Major battle events include a reenactment and experience of selected events at their original sites, such as the Incheon Landing Operations, the Hwaryongjang / Nakdong River Battles, the Korea Strait Naval Battle, the victorious Air Force Operation, and the United Nations Command-engaged Jipyung-ri, the Imjin River, and the Jangjin Reservoir Battles. With the period from June 21<sup>st</sup> to 25<sup>th</sup> being designated as the ‘Week of Recalling the Korean War,’ all units resolved to protect the stronghold, visited battlegrounds, received intensive mental training and engaged in activities to invite and thank veterans, thus promoting security awareness within the military. In addition, in collaboration with the Ministry of Education, Science and Technology, the MND carried out a seminar titled ‘Telling the Truth about Korean War ’for students all over the nation and raised the awareness of service members and the youth regarding national security. For the security training of service members, the following materials were used: "In Mortal Combat: Korea, 1950-1953," by John Toland; the memoirs of General Paik Sun-yup titled "No Me Without Fatherland"; and the video clip "Never Forget." Besides, a ‘Special Exhibition on the Korean War’ was held in the War Memorial of Korea, drawing more than 250,000 visitors.

‘Honor and Gratitude’ consists of programs, including ‘Locating the bereaved of Korean War KIAs,’ ‘A consolation visit to the nations that fought in the Korean War,’ and other events to express gratitude to those who gave their life to uphold liberty with noble courage and priceless sacrifice. Through the ‘Locating the bereaved of Korean War KIAs,’ about 316 bereaved family members out of a total of 18,631 KIAs during the Korean War were found, honored and provided with veterans' benefits. These efforts will continue in connection with the efforts to recover the remains of the Korean War KIAs. Korean War commemoration events were held at locale in the 21 nations that fought in the Korean War, and the Korean War 60<sup>th</sup> Anniversary Office, MND visited Belgium and Colombia to express its gratitude and encouragement. The Naval Academy Midshipmen's Cruise Training Flotilla invited local Korean War veterans and residents during ports of call at nations that fought in the Korean War, in six countries and seven



Reenactment of the Incheon Landing Operations (September 2010)



Reenactment of the Nakdong River battle (Chilgok-gun, Gyeongsangbuk-do, September 3, 2010)

ports, holding ceremonies of consolation and gratitude. The MND has also been promoting the initiative called 'Donate *Wusuri* [Small Change]' to provide aid to the scholarship project for descendants of UN Korean War veterans and for projects designed to improve residential conditions, with the financial resources collected from MND employees.

Under the theme of 'Harmony and Cooperation,' programs were designed to deepen and expand mutual understanding and cooperation for world peace based on blood alliances. For example, cultural and sporting events, such as the Armed Forces Day Event commemorating the 60<sup>th</sup> Anniversary of the Korean War and the Recapture of Seoul, the Korea-Turkey War Victory Commemoration and the Military's Friendship Soccer Matches, a military-produced musical, and an international cycling competition, were held. The Armed Forces Day Event commemorating the Recapture of Seoul was held as a citizen's festival in the Gwanghwamun area to reenact the joy of recapturing Seoul. 'The Korea-Turkey War Victory Commemoration and Soldiers' Friendship Soccer Matches' were held during reciprocal visits between Turkey (June 24 to 27) and Seoul (September 14-19). The ROK national delegation, visiting Turkey, engaged in activities such as the commemoration of Turkey's participation in the Korean War, soccer matches, and an event inviting and expressing appreciation to Korean War veterans; in Korea, the two nations reconfirmed their blood brotherhood by observing a reenactment of the Incheon amphibious operations, playing a soccer match, paying respects at the Busan UN Memorial Cemetery, and tours of Korean military equipment manufacturing facilities. The military musical 'Sailing for Life' is a non-fiction drama about the ship 'Meredith Victoria,' which transported 14,000 refugees during the evacuation of Hungnam operations; it was performed in Seoul and six regional cities. The '2010 Tour de Military Demarcation Line-Seoul International Cycling Competition' involved a 476km-long route by the Military Demarcation Line. This informed the world of the ROK's developments and enhanced the ROK's peace-seeking image through coverage by the domestic and foreign mass media.



Laying of wreaths at the Turkey War Victory Commemoration Event (Korea Park, Ankara, June 2010)



Friendship Soccer Match between the Korean and Turkey military (Seongnam Tanchon Sports Complex, September 2010)

In addition, the MND supported the production of the Korean War based movie 'Into the Fire,' the KBS drama 'War Comrades' and the MBC drama 'Road Number One' and also produced posters, PR leaflets, standing PR materials, and

the bus and subway advertisements 'M-Kiss on the Korean War'<sup>8</sup> (40 pieces). In particular, the MND operates an Internet blog called 'Ah! The Korean War' ([www.korean60.tistory.com](http://www.korean60.tistory.com)) for the new generation of service members and the youth, making known to more than one million netizens the truth about the war and instilling in them the meaning of the 60<sup>th</sup> Anniversary.

The MND has organized and safely preserved as records all documents that were produced during the organization and implementation of the 60<sup>th</sup> Anniversary of the Korean War Project (planning, programs, progress, reports on outcomes) as well as books, PR materials, videos and special feature productions of each media company and the results of the media coverage.

## 5. Efforts to Exhume the Remains of Veterans Killed in Action

**| Significance and progress of the project |** The project to exhume the remains of Korean War veterans killed in action is a national veteran and patriot protection related project to find the bodies of some 130,000 heroes, who gave their lives to protect their country during the Korean War, but remain on the battlegrounds, and to bring them home to rest in the National Cemetery. This project helps comfort and honor the souls of such soldiers and resolves the bereaved families' deep resentment and sorrow that have been ingrained in their hearts over the past 60 years. By doing so, the project seeks to realize the nation's unlimited sense of responsibility to 'be responsible to the end for those who were sacrificed for the country.'

This project began as one initially led by the Army as part of the 50<sup>th</sup> Anniversary of the Korean War Commemoration projects and, in 2003, was divided into the following groups within the Army Headquarters: the KIA (Killed in Action) Remains Excavation Division and the Remains Excavation Team. However, due to there being insufficient records regarding the soldiers killed in action, the efforts to find the locations of the remains were dependent mainly on the information provided by residents of former battle areas and veterans who had themselves buried bodies or had witnessed such an event. In January 2007, the MND Agency for Killed in Action Recovery & ID (MAKRI) was established, comprised of four teams and 85 people, in order to continue the project on a permanent basis at the national level.

## 8. M-kiss (Military Knowledge-Welfare Integrated Service System)

The new concept knowledge-welfare service for military service members.

**Exhuming and identifying remains** | The size of the MND's Agency for Killed in Action Recovery & ID (MAKRI) increased to 179 people in two increments from 2008 to 2009 and, as of December 2010, is made up of five departments (planning, investigation, excavation, identification, support) and eight excavation teams. To systematically carry out the entire process, from the investigation of remains to their recovery and identification, the MND benchmarked the United States' 'Joint POW / MIA Accounting Command (JPAC).' As a result, shown in Figure 10-8, the recovery of the remains of those KIA's increased significantly. In 2010, more than 1,000 remains were recovered, carrying on the results seen in 2009. From the year 2000, when recovery first began, the total number of remains recovered up to date, amounts to 4,713 bodies.

Figure 10-8. Status of Remains Recovery

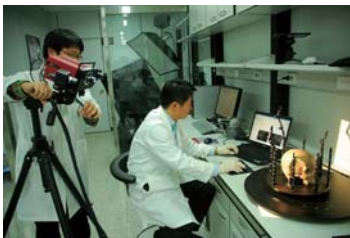
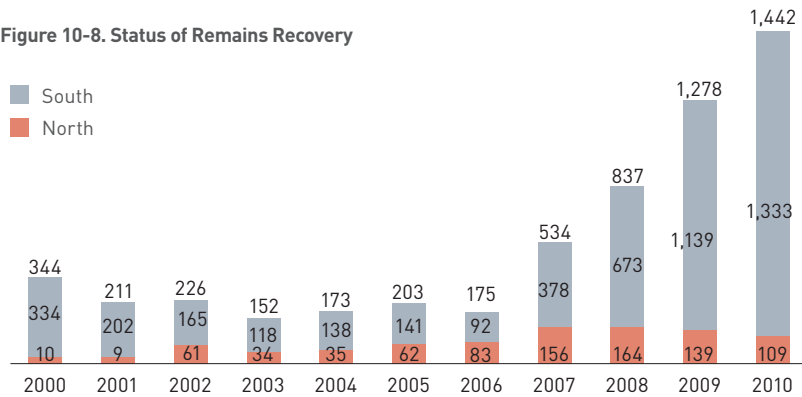

Identifying excavated remains using advanced technological equipment, such as a 3D scanner

Moreover, the number of DNA samples, which are necessary to identify recovered remains, gathered from bereaved family members increased significantly from 2007 onwards. Up to 57% of the total 13,597 samples were collected in 2009 and 2010, since blood samples were first gathered in 2003. In terms of identification, over the last two years, 38 bodies have been identified and the surviving families verified, amounting to 63 percent of the total successful cases (90 remains identified, 60 remains confirmed by surviving families). The 60 remains for which the surviving families were verified have been laid to rest in the National Cemetery, and those that could not be verified were placed to rest in the Chunghondang within the National Cemetery. The obtained blood samples, verification of identity, and verification of surviving families are shown in Table 10-12.

Table 10-12. Obtained Blood Samples and Verification of Identity and Surviving Families

Unit: persons

Classification	2000	2001	2002	2003	2004	2005	2006	2007	2008	2009	2010	Total
Blood samples	-	-	-	357	359	609	516	1,418	2,560	4,452	3,349	13,620
Verification of ID	3	36	3	2	7	0	1	9	13	11	5	90
Verification of surviving family	3	1	9	2	3	2	2	9	13	11	5	60

### | Laying the foundation for the permanence of the project |

Recovering remains is not a project to be continued for a limited period of time. Rather, it is a precious national responsibility that should be carried out until every last soldier killed in action is found. To lay the (legal) foundation for the efforts, the Act on Recovery of Korean War KIAs was enacted on March 21, 2008. In March 2009, a directive by the Prime Minister was enacted and 11 departments and agencies formed a consultative body to support the project at a government-wide level. Furthermore, the expertise of the remains recovery project is being reinforced in order to raise the ratio of verified identities. The MND has taken the following measures: the National Institute of Scientific Investigation within the Defense Investigation HQ is now equipped with DNA testing facilities to allow it to independently analyze DNA samples, rather than depending on private universities or institutes. In addition, the MND has sent specialists on domestic and overseas training programs and has appointed advisory professors in relevant areas.

In January 2009, the office for the MAKRI was opened and included analysis rooms, analysis equipment, and remains preservation rooms. With the help of the latest technology, it is expected that the ratio of DNA samples obtainable from severely damaged remains will increase, thereby significantly increasing the ratio of ID verifications.

In December 2009, the Institute for Military History Compilation analyzed the war history of 323 regions in South Korea and drew up a 1:50,000 scale map marking those regions where soldiers killed in action were likely to have been buried. It then created and distributed 2,700 CDs to battalions and higher level units.



Excavation of remains by the MND Agency for Killed in Action Recovery & ID (MAKRI)

**| Future tasks and directions |** In view of the trend towards an aging society, the next five years will be the most important period for the project to recover remains. Therefore, the MND will build a 'Comprehensive Information System Regarding KIAs' to scientifically and systematically manage and use related materials, such as the results of preliminary investigations of the locales in regions where remains were found and the genetic information of the recovered remains and surviving family members, thus spurring progress in the recovery of remains.

Through these efforts, the MND will do its utmost to reunite a greater number of soldiers that were killed in action with their surviving families and to thus carry out its unlimited responsibility to those who sacrificed themselves to protect their country.

## 6. Efforts of the Military to Realize a 'Fair Society'

**| Basic concept |** The ROK government has drawn up and is putting into practice policy initiatives in three categories, namely 'a more liberal and creative society,' 'a fairer society,' and 'realizing social responsibility,' based on the awareness that the value of a 'fair society' must take root in our society in order for it to continue sustainable growth and co-prosperity and, further, to develop into an advanced nation.

To realize the above in the defense area, the ROK armed forces have been detailing policy initiatives that will contribute towards a 'fair military' being put into practice internally and a 'fair society' being realized externally.

**| Future directions |** The MND hopes to emphasize the following policy directions and initiatives in the future.

First, it will seek to realize 'more autonomous and creative defense' overflowing with creativity and autonomy and where combat and management efficiency are increased. For this purpose, it will create a dynamic defense culture that will permit closer communication with the people; it will provide various opportunities and conditions through training and education whereby service members may display their abilities and



President Lee Myung-bak stressing a 'Fair Society' at the Liberation Day Commemoration Ceremony (August 15, 2010, Gwanghwamun, Seoul)

energy to their heart's content; and it will expand the introduction and application of creative civilian management methods and excellent human resources, equipment and facilities in order to raise efficiency in defense-related tasks.

Second, it will seek to realize a 'fairer defense' by ensuring the principle of equal opportunity and transparency. It will reinforce the surveillance of military service dodgers and establish a culture where every man, who is a citizen of the Republic of Korea, will perform his military service without exception and also take pride in it; it will develop meritocratic HR policies to make use of talented human resources at the right time and place; and supplement the current cost management system to enhance transparency and trustworthiness in the defense procurement process and expand the foundation for competitive contracts.

Third, it will seek to realize a 'socially responsible defense' that will repay individuals for their dedicated service, be considerate of the weak, and become one with the people. It will improve the respect paid to and allowances for those who sacrificed and dedicated themselves to their country, such as persons of merit during a war, ROK POWs and their families, and soldiers killed in action; it will strengthen aid to marginalized social groups that require care from in and outside of the military, such as residents near a unit or enlisted service members from multicultural families; also, in the defense industry, it will seek institutional support measures to enable win-win cooperation between small-and-medium enterprises (SMEs) and large cooperations.

In addition, the MND will become more active in the sharing and volunteer activities it has engaged in, such as volunteer work at farms through a one unit, one village, one school sisterhood relationship, operation of direct transaction marketplaces, assisting in security training for nearby schools and residents and other specific projects that can be carried out in everyday life as they are steadily discovered. The ROK forces will, through these efforts, enhance its combat capability and enhance the efficiency of its organization, as well as gaining even greater love and trust from the public.

# Appendix

## Special Appendix

1. Recollections about the Korean War
2. North Korea's Infiltrations and Provocations against South Korea and Naval Campaigns at the Northern Limit Line (NLL)
3. Attack against the ROKS Cheonan
4. Artillery Firing at Yeonpyeongdo (Island)

## Appendix

1. Status of Neighboring Countries' Military Strength
2. Comparison between Major Countries' Defense Budgets
3. Comparison of the Military Strength of the Two Koreas
4. Comparison of the Economic Indicators of the Two Koreas
5. Negotiation Process in North Korea's Nuclear Programs
6. History of North Korea's Missile Development Program and Specifications
7. Chronology of South-North Military Talks
8. Chronicle of Inter-Korean Relations
9. Status of UN Peacekeeping Operations
10. Budget for ROK Military Units Dispatched Overseas
11. Status of Dispatch of ROK Troops Overseas
12. Status of Countries Participating in the International Security Assistance Force (ISAF)
13. The Act on Participation in UN Peacekeeping Operations
14. Joint Communiqué of The 41<sup>st</sup> ROK-U.S. Security Consultative Meeting
15. Joint Communiqué of The 42<sup>nd</sup> U.S.-ROK Security Consultative Meeting
16. The Guidelines for ROK-U.S. Defense Cooperation
17. Joint Statement of ROK-U.S. Foreign and Defense Ministers' Meeting on the Occasion of the 60<sup>th</sup> Anniversary of the Outbreak of the Korean War
18. Major Arms Control Conventions and Organizations
19. National Defense Organizations
20. Annual Defense Budgets
21. Defense Industrial Cooperation Agreements with Other Countries
22. Changes in Compulsory Military Service Period
23. Alternatives to Military Service
24. Combined/Joint Military Exercises and Training
25. Composition and Major Activities of National Assembly Defense Committee
26. Revision Details of Laws and Ordinances Related to the Ministry of National Defense (MND)







War Memorial of Korea

## 1945 - 1950

### Establishment of the North Korean regime and its preparations to invade the South

With Japan's unconditional surrender in World War II on August 15, 1945, Koreans looked forward to the restoration of their country's sovereignty. However, the homeland was instead divided into two at the 38<sup>th</sup> parallel. Even before the establishment of the regime, Kim Il Sung, the North's leader, started making preparations for war in order to gain control of the South. The Korean People's Army (KPA) of the North was mobilized with the support of the Soviet Union.

**August 15, 1945**  
The country's liberation from colonial rule

**October 14, 1945**  
Rallies to welcome Kim Il Sung in Pyongyang

**November 1945**  
Launch of the Security Squads

**February 8, 1948**  
Establishment of North's regular army

**September 9, 1948**  
Establishment of North's regime

**April 3, 1950**  
USSR leader Joseph Stalin approves the North's plan to invade the South

**June 22, 1950**  
The North's troops deployed along the 38<sup>th</sup> parallel



**Rallies welcoming Kim Il Sung (October 14, 1945)**  
USSR establishes a Communist regime led by Kim Il Sung, an ex-Soviet Army major, upon entering into the North.



**Mass rally congratulating the founding of the North Korean regime (September 9, 1948)**  
Kim Il Sung starts making preparations to invade the South through rigorous steps, including the founding of the KPA..

#### Comparison of the military strength of the two Koreas right before the outbreak of the Korean War

The South		The North	
103,827	Troops	201,050	<ul style="list-style-type: none"> <li>• Army, 182,680: 10 divisions and support units</li> <li>• Navy/Marine Corps, 15,570: Waters Defense Command, Marine Corps</li> <li>• Air Force, 2,800: one air division</li> </ul>
<ul style="list-style-type: none"> <li>• Army, 94,974: eight divisions and support units</li> <li>• Navy/Marine Corps, 6,956: seven guard units and Marine Corps units</li> <li>• Air Force, 1,897: one flight wing and seven bases</li> </ul>		Tanks: 242	
Tanks: 0	Tanks and armored vehicles	Armored vehicles: 54	
Armored vehicles: 27			
1,051	Artillery guns	2,492	<ul style="list-style-type: none"> <li>• Self-propelled artillery (SU-76): 176</li> <li>• 122mm · 76mm howitzers: 552</li> <li>• Anti-aircraft artillery (85mm · 37mm): 36</li> <li>• 120mm · 82mm · 60mm mortar launchers: 1,728</li> </ul>
<ul style="list-style-type: none"> <li>• Self-propelled artillery: 0</li> <li>• 105mm M3 howitzers: 91</li> <li>• 81mm, 60mm mortar launchers: 960</li> </ul>		550	
2,040	Anti-tank artillery	Anti-tank guns (45mm): 550	
<ul style="list-style-type: none"> <li>• Anti-tank guns (2.36"): 1,900</li> <li>• 57mm recoilless rifles: 140</li> </ul>			
36	Naval ships	110	
Patrol craft: 36		Patrol craft: 30 / auxiliary boats: 80	
22	Aircraft	226	YAK-9, IL-10, TU-2, Reconnaissance aircraft
L-4: 8, L-5: 4, T-6: 10			

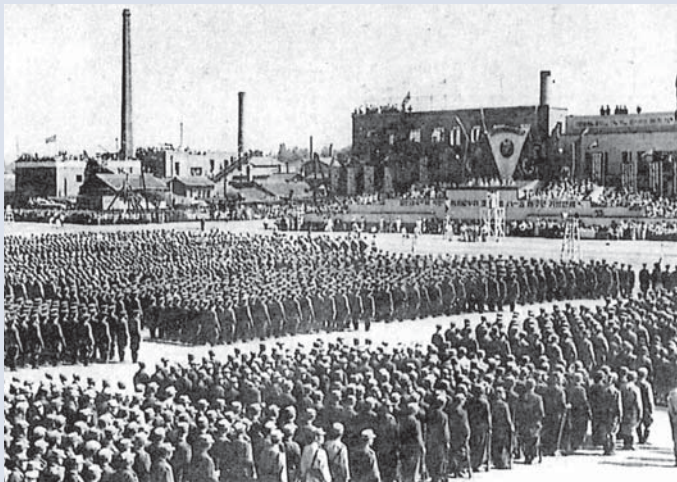

**North's troops at ceremony commemorating the 4<sup>th</sup> anniversary of the country's liberation (August 15, 1949)**  
In December 1948, the leaders of the Soviet Union, China and the North agreed to enhance the North's forces extensively at a confidential military meeting in Moscow.

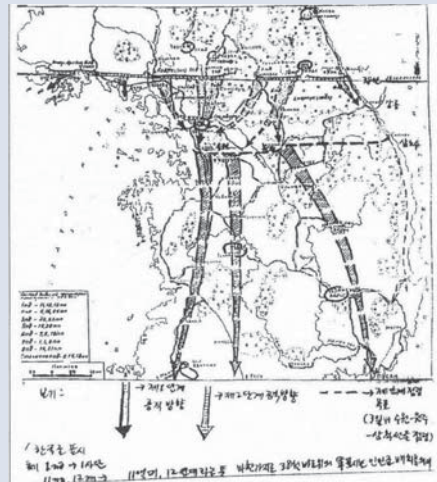

**The North's invasion plan upon the South**  
Yonhap News Agency obtained this from the Russian Academy of Military Science in 1992.

# June 25-28, 1950 **The North's invasion upon the South and occupation of Seoul**

The North's forces launched a surprise attack on the South, along the entire border, at daybreak on June 25 (Sunday), 1950. Totally unprepared, the South, led by President Syngman Rhee, lost its capital Seoul in only three days. The main forces of the South's military had collapsed even before they had retreated south of the Han River, endangering the South.

**June 25, 1950**  
The North launches surprise attack on the South, along the entire border

**June 25, 10:00**  
The North occupies Dongducheon and Pocheon

**June 26, 13:00**  
The North occupies Euijeongbu

**June 27, 10:00**  
The North breaks through the Chang-dong, Seoul, defense line.

**June 28, 10:00**  
The North breaks through the Miari, Seoul, defense line.

**June 28, 11:30**  
The North occupies all of Seoul.



**North's guns firing shots at the South (June 25, 1950)**  
The North's 85mm howitzers deployed along the 38<sup>th</sup> parallel start firing shots at the South, signaling the outbreak of the three-year Korean War.



**A North Korean tank entering downtown Seoul (June 28, 1950)**  
The North's tanks break through the Miari, Seoul, defense line and enter downtown Seoul around 01:00 on June 28.



**The Han River Bridge destroyed (June 28, 1950)**  
The Han River Bridge blown up at 2:30 AM on June 28, 1950 as ordered by ROK Army Chief of Staff Gen. Chai Byeong-deok, upon hearing the report that the North's tanks have entered Seoul.



**A soldier on watch from the South of the Han River (June 28, 1950)**  
Following the destruction of the Han River Bridge, the South's troops that were isolated in north of the Han River, were reorganized and kept a defensive line south of the Han River until July 3, 1950.



# June 29, 1950- September 14, 1950 **UN forces' participation and delay operations in the war**

Urgently held a day after the North's all-out attack on the South on June 26, 1950, the UN Security Council demanded the North to immediately cease its aggression. On June 28, the UN Security Council decided to take military sanctions against the North. Thus, the militaries of the liberal democratic countries friendly with the South, including the U.S., came to the South's aid, under the UN flag. In the beginning, they could not deter the North's troops and had to retreat down to the south of the Nakdong River near Busan.

**June 29, 1950, 11:45**  
General MacArthur's inspection of the frontline

**June 30, 05:00**  
U.S. President Harry S. Truman's approval of the dispatch of U.S. ground forces to Korea

**July 1, 14:00**  
Arrival of a U.S. Army unit from Japan led by Lt. Col. Charles Smith in Busan

**July 1-July 4,**  
Deployment of the U.S. Army 24<sup>th</sup> Division in Korea

**July 20**  
The North's occupation of Daejeon

**August 1-September 14**  
Battles at the defense line along the Nakdong River

The 16 countries that dispatched combat troops to aid South Korea, under the UN flag: the U.S., UK, Canada, Turkey, Australia, the Netherlands, New Zealand, the Philippines, Thailand, Colombia, Greece, Ethiopia, Belgium, France, South Africa, and Luxembourg

The five countries that dispatched medical corps or supplies for South Korea: Denmark, India, Norway, Sweden, and Italy

## UN Security Council meeting (June 28, 1950)

The UN Security Council decides to restore peace on the Korean Peninsula by means of military sanctions against North Korea when it did not comply with the UN's demand that it cease its acts of aggression.



## North's troops entering Daejeon, a strategically important location in the country's central area (July 20, 1950)

Members of the U.S. Army 24<sup>th</sup> Division stationed in Japan were urgently dispatched to South Korea, but they were defeated in one battle after another against the North in Osan, Cheonan, Geumgang and Daejeon.



## UN aircraft carpet bombing enemy positions (11:58 ~ 12:24, August 16, 1950)

99 UN Forces B-29 bombers dropped 960 tons of bombs over enemy positions to the northwest of Waegwan.

## Major battle positions along the Nakdong River defense line (August 1-September 14, 1950)

Between August 1, 1950, and mid-September of the same year, ROK and UN troops were engaged in a life-or-death struggle against the enemy along the Nakdong River and mountainous areas near the East Coast.



# September 15-30, 1950

## Incheon Landing Operations / Reclaiming the lost area south of the 38<sup>th</sup> parallel

The UN forces landed at Incheon on September 15, succeeded in cutting off enemy logistics routes, and reclaimed Seoul on September 28. Thus, the main force of the North's troops collapsed. The South's allies reclaimed the entire area south of the 38<sup>th</sup> parallel, which had been lost to the enemy.

**September 15, 1950, 06:33**  
UN advance forces land on Wolmido Island

**September 16, 18:00**  
Incheon retaken

**September 18, 08:00**  
Gimpo Airfield near Seoul retaken

**September 26, 22:26**  
The landed force joined up with friendly troops advancing northward.

**September 28**  
Seoul retaken

**September 30**  
Restoration of 38<sup>th</sup> parallel as frontline

**The passage used by the invading UN forces (i.e., the waterway at Incheon Port)**

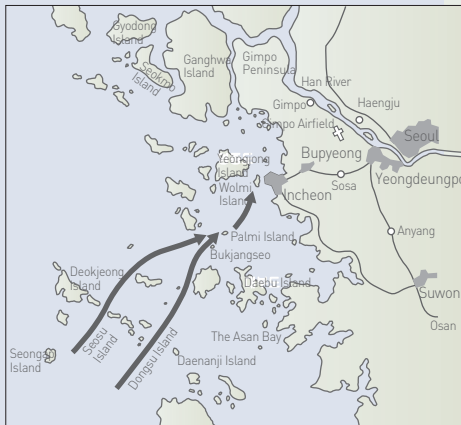

**Route used by U.S. Army 10<sup>th</sup> Corps**

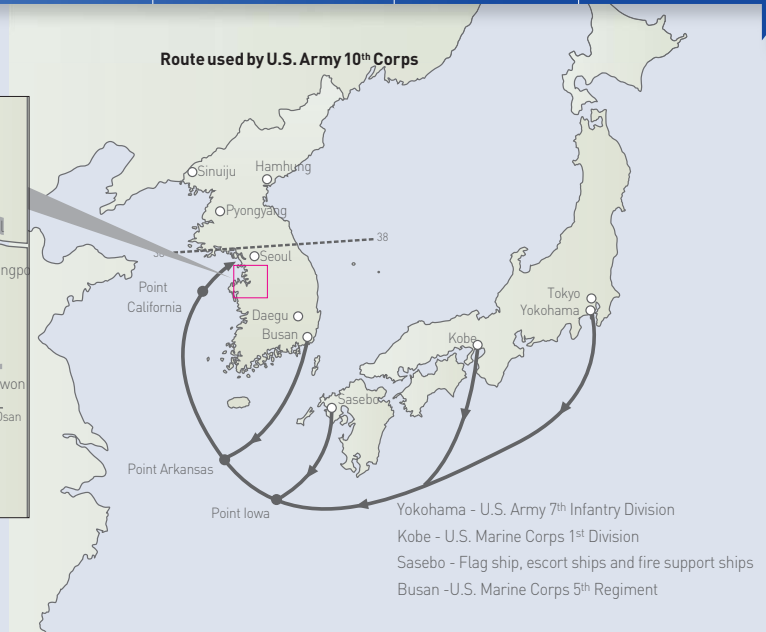

Yokohama - U.S. Army 7<sup>th</sup> Infantry Division  
Kobe - U.S. Marine Corps 1<sup>st</sup> Division  
Sasebo - Flag ship, escort ships and fire support ships  
Busan - U.S. Marine Corps 5<sup>th</sup> Regiment



**ROK Marine Corps landing at Incheon (September 15, 1950)**

Col. Shin Hyeon-jun led the 3,000-troop ROK Marine Corps 1<sup>st</sup> Regiment (recruited on Jeju Island) to join the UN forces that had landed at Incheon.



**General Douglas MacArthur, Supreme Commander of the United Nations Forces in Korea, during the Incheon Landing Operation (September 15, 1950)**

The landing UN forces were comprised of approx. 75,000 troops and 261 naval ships. The operation was joined by the ROK fleet led by Admiral Son Won-il, Chief of ROK Naval Operations, the ROK Marine Corps 1<sup>st</sup> Regiment, and the ROK Army 17<sup>th</sup> Regiment.



**UN forces advancing toward the 38<sup>th</sup> parallel (September 19, 1950)**

Allies started counteroffensives in Waegwan to reclaim the land south of the 38<sup>th</sup> parallel that had been lost.



**Hoisting the ROK national flag after reclaiming Seoul from the enemy (September 28, 1950)**

Members of the ROK Marine Corps' 1<sup>st</sup> Regiment, 2<sup>nd</sup> Battalion, hoisted the Taegeukgi, the national flag of South Korea at the Jungangcheong (Capitol Building) in Seoul, which had been occupied by the enemy for 90 days.

# October 1-24, 1950 UN forces advance northward across the 38<sup>th</sup> parallel

The ROK Army's 1<sup>st</sup> Corps broke through the 38<sup>th</sup> parallel in an area close to the East Coast on October 1, at the order of President Syng-man Rhee, dreaming of unification of the country. The UN forces advanced northward toward the Amnok (Yalu) River and the Duman (Tumen) River, in accordance with a UN Security Council resolution, after crossing the 38<sup>th</sup> parallel in a central region and an area near the West Coast on October 9.

**October 1, 1950, 08:10**  
The ROK Army's 23<sup>rd</sup> Regiment marches northward past the 38<sup>th</sup> parallel ahead of the other units.

**October 9, 09:00**  
The UN forces advance past the 38<sup>th</sup> parallel.

**October 10, 10:00**  
The ROK 3<sup>rd</sup> and Capital Division retake Wonsan.

**October 20, 10:00**  
The ROK Army's 1<sup>st</sup> Division captures Pyongyang.

**October 26, 14:15**  
The ROK Army's 7<sup>th</sup> Regiment reaches a section of the Amnok (Yalu) River north of Chosan.



**Members of the ROK Army's 23<sup>rd</sup> Regiment reach the 38<sup>th</sup> parallel ahead of the other units (October 1, 1950)**  
Troops of the ROK Army's 23<sup>rd</sup> Regiment, 3<sup>rd</sup> Division setting up a signboard commemorating their crossing of the 38<sup>th</sup> parallel in Yangyang, near the East Coast, as the first unit to reach the parallel.



**A map showing the status of the UN forces' advance toward the border with China**



**ROK BG Paik Sun-yup and U.S. MG Frank W. Milburn (October 20, 1950)**

BG Paik, Commander of the ROK 1<sup>st</sup> Division explains the status of the advance near the Daedong River to MG Milburn, Commander of the U.S. 1<sup>st</sup> Corps. MG Milburn meets with BG Paik after the South Korean general led his troops to Pyongyang ahead of the other units.



**North Koreans welcoming ROK troops (October 24, 1950)**

Local residents in Hichon, Pyonganbuk-do, North Korea, welcome troops of the ROK 6<sup>th</sup> Division advancing northward.



**President Syng-man Rhee in Pyongyang (October 29, 1950)**

North Koreans in Pyongyang cheer President Rhee at a rally celebrating ROK troops' taking the city.

**A ROK soldier filling his canteen with water from the Amnok (Yalu) River (October 26, 1950)**

On October 26, 1950, at 14:15, the 1<sup>st</sup> Company, 7<sup>th</sup> Regiment, ROK 6<sup>th</sup> Division, as an advance unit reaches a section of the Amnok (Yalu) River in Yangtori, north of Chosan.



# October 25, 1950- July 9, 1951

## Intervention of Communist Chinese troops: a new phase in the war

On October 19, 1950, Communist Chinese troops stealthily crossed the Amnok (Yalu) River and carried out a surprise attack on the ROK and UN forces. They pushed the ROK and UN forces down to the 37<sup>th</sup> parallel (the Pyeongtaek-Samcheok line) in three large-scale offensives. After withstanding later offensives by the Chinese troops [4<sup>th</sup> through 6<sup>th</sup> offensives], the Allies carried out a series of counteroffensives, pushing the Chinese forces back to the 38<sup>th</sup> parallel.

**October 25-November 7, 1950**  
The Communist Chinese troops' 1<sup>st</sup> offensive

**November 25-December 22**  
The Communist Chinese troops' 2<sup>nd</sup> offensive/The UN forces' withdrawal from Pyongyang

**December 31, 1950-January 8, 1951**  
The Communist Chinese troops' 3<sup>rd</sup> offensive and occupation of Seoul

**January 15-22, 1951**  
The UN forces' 1<sup>st</sup> counteroffensive

**March 15, 1951**  
The UN forces' restoration of Seoul

**June 23, 1951**  
The Soviet Union's proposal of a ceasefire

### Communist Chinese troops crossing the China-Korea border (October 19, 1950)

Subordinate units of Communist China's 4<sup>th</sup> Field Army were deployed in the northeastern provinces of China in April 1950, i.e., right before the outbreak of the Korean War.



**Chinese General Peng Dehuai and Kim Il Sung (date unknown)**  
Kim Il Sung (center) and Peng Dehuai (to Kim's right) pose for a picture when the former paid a visit to Communist China's Command Headquarters in an underground cave.

### Refugees on destroyed railroad bridge over the Daedong River (December 1950)

North Koreans moving southward for freedom



### Second retreat from Seoul on a piercingly cold January day in 1951 (January 4, 1951)

Seoulites seeking refuge southward due to Communist Chinese troops' 3<sup>rd</sup> offensive. The location is near present-day Gwacheon.



### The ROK 1<sup>st</sup> Division crossing the Han River (March 14, 1951)

The ROK 1<sup>st</sup> Division advances toward Mapo after crossing the river to liberate Seoul for the second time during the Korean War.



### Street skirmishes in Seoul (March 15, 1951)

Troops of the ROK 1<sup>st</sup> Division engaged in street skirmishes against the enemy in present-day Mapo, Seoul.

# July 10, 1951- July 27, 1953

## Ceasefire negotiations, struggles to occupy hilltops, Armistice

The first ceasefire meeting was held in Kaesong on July 10, 1951. The Communist side delayed the negotiations in an attempt to rebuild its military power. The ROK and UN forces countered such a tactic with strong military operations. After two years of long negotiations amid fierce combats, the two sides finally signed the Armistice Agreement on July 27, 1953.

**July 10, 1951**  
Commencement of the ceasefire meeting

**October 25**  
Agreement to the installation of the truce line

**December 11**  
Commencement of negotiations for the exchange of POWs

**April 2, 1953**  
Exchange of ill and injured POWs

**June 18**  
The South's release of anti-Communist POWs

**July 3-July 20,**  
Communist Chinese troops' last offensive

**July 27, 22:00**  
Effectuation of the Armistice Agreement

### Major combat areas toward the end of the Korean War and the final Military Demarcation Line (MDL) (July 10, 1951-July 27, 1953)

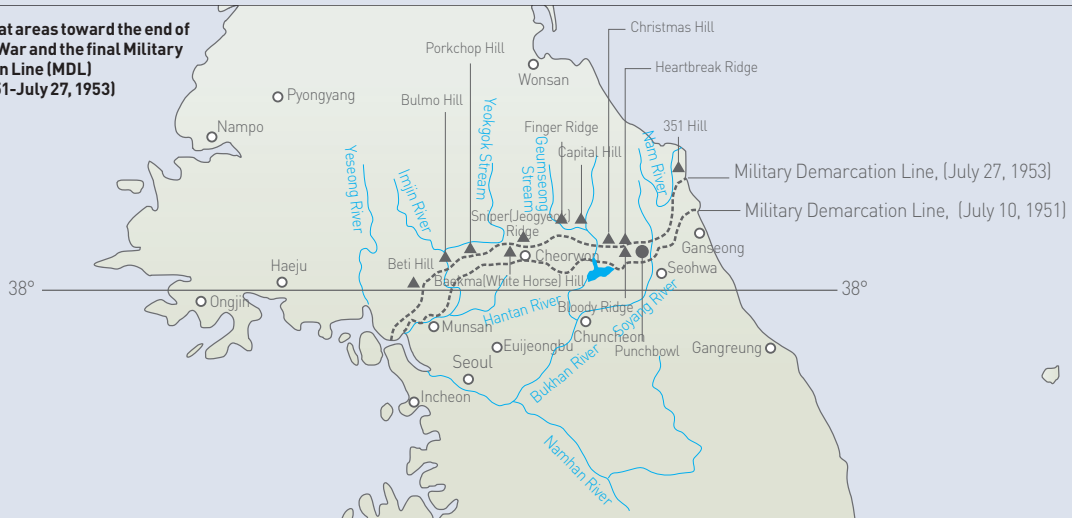

#### The 1<sup>st</sup> ceasefire meeting (July 10, 1951)

The two sides met for discussions about a ceasefire at the Naebongjang Hotel in Kaesong but the meeting ended with no progress.

#### Meeting to set the MDL (November 1951)

Representatives of the two sides are setting the Military Demarcation Line (MDL).



#### The South's civilian carrier team members help troops carry recoilless rifles (date unknown)

Many civilians, including bogukdae (defense militia) civilian carrier teams and nomudan (Korean Service Corps) provided conspicuous support for the troops during the Korean War.



#### U.S. troops at Old Baldy Hill (June 1952)

Soldiers of U.S. Army 45<sup>th</sup> Division are building a defense position on Old Baldy Hill northwest of Yeoncheon, Gyeonggi-do.

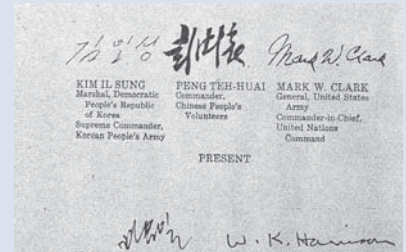

#### The Armistice Agreement signed by the two sides



# June 25, 1950- July 27, 1953.

## Results and evaluation of the war

Deep scars of the war still remain in the hearts of Koreans. The 37-month-long war turned the entire country into rubble. It left an indelible scar in the minds of all Koreans, including the more than 3 million lives lost, more than 10 million separated family members, and numerous war orphans.

### War casualties for the ROK and UN forces

unit: no. of persons

Classification	KIAs and those who later died as a result of wounds received in action	WIAs	MIAs and POWs	Total
ROK forces	137,899	450,742	32,838	621,479
UN forces	40,670	104,280	9,931	154,881
Total	178,569	555,022	42,769	776,360

\* War casualties for the Communist forces (estimation): 1,773,600 [Those killed in action and wounded: 1,646,000 and those missing in action and POWs: 127,600]

### Civilian casualties

unit: no. of persons

Those massacred or otherwise killed	Those wounded	Those kidnapped or missing	Total	Other victims
373,599	229,625	387,744	990,968	Refugees: 3.2 million, war widows: 300,000, war orphans: approx.100,000

\* North Korean civilian casualties (estimation): 1.5 million



#### Civilians massacred by the North's troops (date unknown)

In most of the areas occupied by the North's troops, a large number of civilians were massacred.



#### A medical officer helps a disabled soldier with a wooden artificial leg

The war left a total of 550,000 wounded soldiers in the South.



#### Ruined area near Jungangcheong (Capitol Building) in Seoul (September 1950)



#### War orphans on Jeju Island (December 20, 1950)

The war left approx. 100,000 war orphans.

## Historic Evaluation of the Korean War

- It was a war started by Kim Il Sung, with the support of Joseph Stalin from the Soviet Union and Mao Zedong from China, amidst the confrontation between the U.S. and the Soviet Union that had come about following the end of WWII. It was an international war but close to internal strife in nature.
- It was a tragic internecine war. The ROK halted the spread of Communism with the support of the UN member countries. It was a war that defended the free world and brought victory for liberal democracy.

# North Korea's Infiltrations and Provocations against South Korea and Naval Campaigns at the Northern Limit Line (NLL)

## Infiltrations and Provocations against South Korea

### General Status (1954-November 2010)

Classification	Number of cases	Description
Infiltrations	Approx. 1,640	720 cases by land, 920 cases by sea
Local provocations	Over 1,020	-470 cases by land (90 cases of shootings and artillery fires, 70 cases of raids and abductions, etc.) -510 cases by sea (490 cases of naval ships/fishing boats crossing the border, 20 naval engagements) -40 cases by air (20 cases of infiltrations into South Korean airspace / 10 cases of missile-launching, etc.)

### Major Cases of Infiltrations and Provocations against South Korea

February 16, 1958	KNA commercial airliner on domestic flight from Busan to Seoul with 34 passengers aboard is hijacked by North Korean agent (only 26 sent back to South on March 6, same year).
January 14, 1964	ROK F-86D fighter on training mission crosses into the North's airspace due to radio malfunction and was shot down (North returned pilot's body on January 17, 1964).
January 19, 1967	NK's coastal artillery deployed along East Coast fires on and sinks ROKS Dangpo (PCE-56) while it guarded fishing vessels (39 crew members killed and 12 severely wounded).
January 21, 1968	31 commandos from North's 124 <sup>th</sup> Unit mounts assault near Cheongwadae (residence of South's president) (29 guerrillas killed, one caught alive, and one escaped).
January 23, 1968	USS Pueblo, a U.S. Naval intelligence ship, captured by North in international waters (all crew members, except for one who was killed, returned home on December 23, 1968).
October 30 ~ November 3, 1968	120 armed members from NK's Special Forces infiltrate Ulsan and Samcheok (killed 107, caught 4, surrendered 3, and escaped 6).
April 15, 1969	US EC-121 reconnaissance plane is shot down while carrying out a reconnaissance mission above international waters southeast of Cheongjin (all 31 crew members killed).
June 22, 1970	Accidental detonation of explosive planted on roof of entrance to National Cemetery in Seoul (one North Korean agent killed instantly, two fled).
August 15, 1974	Mun Se-kwang, a pro-Pyongyang resident from Japan, attempts to assassinate President Park Chung-hee in Seoul's National Theater during ceremony commemorating the country's liberation. (first lady Yuk Yeong-su killed).
November 15, 1974	First NK's infiltration tunnel under DMZ is found in Gorangpo, Yeoncheon-gun, Gyeonggi-do.
March 24, 1975	Second NK's infiltration tunnel under DMZ is found in Cheolwon-gun, Gyeonggi-do.

August 18, 1976	Axe murder incident at Panmunjom (two U.S. officers are hacked to death and four U.S. enlisted men and four KATUSA soldiers injured). * The North suggests that the Military Demarcation Line (MDL) should be enforced throughout the Joint Security Area (JSA), on August 25, effective September 16, 1976.
July 14, 1977	U.S. CH-47 strays into North's airspace near east coast and is shot down (three U.S. servicemen killed and one survivor returned).
October 17, 1978	Third NK's infiltration tunnel under DMZ is found near Panmunjom.
December 3, 1983	NK's Spy ship was caught and sunk while trying to infiltrate Dadaepo Beach, Busan (two crew members captured).
September 14, 1986	Arrival area (1 <sup>st</sup> floor) of Gimpo Airport partially destroyed by explosives.
January 15, 1987	Fishing vessel No.27 Dongjin-ho, with 12 fishermen aboard, is hijacked forcefully to NK's while fishing in international waters off Baengnyeong Island.
November 29, 1987	Korean Air flight (KAL 858) is blown up in midair by NK (All 115 aboard, including crew, killed).
January 28, 1989	Fishing vessels No. 37 Taeyang-ho (with 12 fishermen aboard) and No.38 Taeyang-ho (with 10 fishermen aboard) taken forcefully to North while fishing in international waters off the northwest of Baengnyeong Island in West Sea.
March 3, 1990	Fourth NK's infiltration tunnel under DMZ found in Yanggu-gun, Gangwon-do.
September 2, 1995	Two agents belonging to North's Worker's Party infiltrate beach at Onpyeong-ri, Jeju Island.
April 5, 1996	NK soldiers (estimated between one or two companies) demonstrate their military power in the Joint Security Area at Panmunjom.
September 16, 1996	Sango-class submarine from the NK's Reconnaissance Bureau captured while infiltrating beach in Daepodong, Gangneung (One caught, 13 shot and killed, 11 committed suicide, and one submarine captured).
August 2, 1997	Two agents assigned to North's Workers' Party infiltrated beach in Galgot-ri, Geoje Island.
October 17, 1997	Two South Korean residents in Daeseongdong Village close to border taken forcefully to North while working in field (returned to South on October 20 after the matter raised at secretary's meeting at Panmunjom).
June 21, 1998	Yugo-class submarine from North's Workers' Party captured while infiltrating beach in Susan-ri, Yangyang-gun, Gangwon-do (all nine aboard committed suicide, one submarine captured).
November 20, 1998	A small speed boat assigned to the Workers' Party attempts to infiltrate beach in Seonsu-ri, Ganghwa Island but fled when spotted.
December 17, 1998	NK's submersible boat sunk while trying to infiltrate beach on Dolsan Island, Yeosu (bodies of its six crew members recovered, one submersible boat captured and salvaged).
June 15, 1999	1 <sup>st</sup> Yeonpyeong Naval Campaign breaks out after NK's patrol boat crosses the south of NLL and starts to shoot first to ROK navy ship.
June 29, 2002	2 <sup>nd</sup> Yeonpyeong Naval Campaign breaks out after NK's patrol boat crossed the south of NLL and carries out a surprise attack to ROK's navy ships.
November 10, 2009	Daechong Naval Campaign breaks out after NK's patrol boat crosses NLL and launched surprise attack on ROK's navy ships.
March 26, 2010	ROK Ship Cheonan, from the 2 <sup>nd</sup> Fleet, sunk by North-instigated torpedo attack 2.5km south of Baengnyeong Island (46 crew members killed).
November 23, 2010	Coastal artillery guns and multiple rocket launchers (MRLs) of the North's 4 <sup>th</sup> Corps fire shells at Yeonpyeong Island (two soldiers and two civilians killed, sixteen soldiers and many civilians wounded).

# Naval Campaigns in the Northern Limit Line (NLL) Waters



## First Yeonpyeong Naval Campaign

### Outline

On June 15, 1999, patrol boats from the North carried out a surprise attack on ROK navy ships at an area 8NM (or 15km) southwest of Yeonpyeong Island and 4.3NM (8km) south of the NLL. The South's speed boats shot back. Between June 7 and June 15, many NK's patrol boats and fishing vessels crossed the NLL to the southwest of Yeonpyeong Island. The ROK navy ships tried to make them return to their area without using force. When the NK's patrol boats shot first at 09:28 on June 15, the ROK naval vessels returned fire immediately and drove them away.

- Participants of the engagement: ROK - eight patrol killer medium (PKMs), two patrol combat corvettes (PCCs) / North Korea – four patrol boats and three torpedo boats.

### Development of the operation

- Between June 7 and 10, three to seven NK's patrol boats crossed the NLL into the ROK's waters by 1.6 to 4.9 NM (or 3 to 9km) at an area 5.5 NM (10km) southwest of Yeonpyeong Island, under the pretext of protecting their fishing vessels. The ROK's PKMs were dispatched and conducted operations to withdraw to their side in compliance with Rules of Engagement and relevant international laws. The North's navy ships did not comply with the request and continued hostile actions, including damaging the ROK's navy ships by conducting a ramming operation.

- On June 11, the ROK's PKM countered the North's provocative acts by ramming the stern of the North's patrol boats. The North's patrol boats continued to cross the NLL and physically ram the ROK's PKM. The ROK's PKM which features swift maneuverability, countered the North's boats by means of tactical evasive and siege maneuvers.
- At 08:55 on June 15, NK's seven patrol boats crossed the NLL and started conducting a provocative ramming operation against the ROK navy ships again, and the ROK's PKM responded by carrying out a ramming operation, crashing into the stern of one of the North's patrol boats.
- At 09:28, the NK's patrol boats initiated live fire, and the ROK's PKM returned fire in self-defense. The naval campaign lasted for 14 minutes until 09:42.
- At 09:42, the ROK navy ships stopped firing to allow the NK to rescue its crew members and tow away its damaged vessel out of humanitarian consideration. In addition, the ROK ordered its patrol craft to move southward to ensure the safety of its vessels and prevent a possible escalation.

### Consequences

- One NK's torpedo boat was sunk. Four patrol boats and one torpedo boat were damaged. There were many casualties. Being severely damaged, the NK's ships returned to their area.
- The ROK's five PKMs got slight damage and nine sailors were slightly wounded.

### Lessons learned

- The incident demonstrated that there has been no change in the North's hostile nature and its long-held basic policy toward South Korea, a forceful unification, even in a situation where private-sector inter-Korean exchanges are growing and the ROK Government is implementing a policy of providing economic aid to the North. The incident, consequently, offered a chance for South Koreans to raise their sense of national security.
- The ROK Navy resolutely countered the North's surprise attacks, in accordance with Rules of Engagement, and dominated the enemy. It displayed its qualitative superiority and came to have a sense of confidence in its ability to defend against NK's attacks.



An ROK navy PKM rams the stern of a patrol boat from the North to make it return to the North's waters after it intruded south of the NLL.

## Second Yeonpyeong Naval Campaign

### Outline

On June 29, 2002, patrol boats from the North committed its preemptive firing at an area 3NM (5.6km) south of the NLL and 15 NM (or 28km) to the southwest of Yeonpyeong Island. The ROK's PKMs returned fire. At 09:54, on June 29, the North's two patrol boats crossed the NLL in an area to the west of Yeonpyeong Island, and the South's PKM Division took actions to return the North to their area. At 10: 25, the North's patrol boats carried out preemptive surprise firing toward the ROK Navy ships. Even under the North's preemptive surprise attack, the South immediately counter-fired, destroying the North's boats and forcing the North to retreat to their territory.

- Participants of the engagement: The ROKs two PCCs (patrol combat corvettes) and six PKMs / The NK's two patrol boats

## Development of the operation

- Between 09:54 and 10:01 on June 29, two patrol boats from the North (one based in Deungsan Cape and the other on Yuk Island) crossed the NLL. Seeing two PKM Divisions from the South approaching for an interdiction maneuver, the one from Yuk Island moved northward.
- At 10:23, the one from Deungsan Cape continued to move southward to an area 3NM (5.6km) south of the NLL. The South's PKM Division carried out interdiction maneuvers at the front line (0.5NM, 0.9km).
- At 10:25, the North's patrol boat, using its 85mm naval gun, fired surprise shots at the South's Chamsuri-357 that was positioned at the rear of the Division. The Chamsuri-357 and 358 immediately returned fire in response.
- Between 10:30 and 10:56, the two PKM Divisions and two PCCs from the South, which had come to the aid of those that were at the scene, fired shots, delivering severe damage to the North's patrol boat and forcing it to retreat.
- At 11:59, Chamsuri-357, which was the victim of the enemy's surprise attack, sank when its engine room flooded, while being towed toward its home base.

## Consequences

- One NK's patrol boat was severely damaged. Approx. 30 crew members were killed or wounded.
- One ROK's PKM sunk while being towed toward its home base. Six crew members were killed and 18 wounded.

## Lessons learned

- The ROK Navy punished the North's vicious surprise attack, with its invincible fighting will, thus blocking the NK's intention to invalidate the NLL.
- The ROK Navy realized the need to streamline response procedures for cases of enemy boats crossing the NLL, to reinforce the firepower of its naval vessels in close-range response maneuver operations against enemy surprise attacks, and to set up countermeasures to ensure crew member survival.

## Daecheong Naval Campaign

### Outline

On November 10, 2009, patrol boats from the North fired aimed shots at an area 6NM (11km) to the east of Daecheong Island and 1.2NM (2.2km) south of the NLL. The ROK's PKMs returned fire in the process of evicting the North's patrol boat. At 11:27, on November 10, one NK's patrol boat crossed the NLL. The ROK Navy gave a warning radio message three times and fired warning shots three times in accordance with the Rules of Engagement. The North's patrol boat fired approx. 50 rounds intentionally aimed at ROK ships, and the South's PKM Division returned fire immediately in self-defense.

- Participating naval vessels: One ROK's frigate, two PCCs, and four PKMs / The North – a patrol boat

### Development of the operation

- At 09:45, on November 10, an unidentified vessel suspected to be a fishing vessel from the North was spotted moving southward in the direction of the NLL. A ROK's PKM Division approached the scene immediately.
- At 10:33, a NK's patrol boat, based on Wollae Island, started moving in the direction of the unidentified vessel. In response, a Division of ROK Navy high-speed patrol craft started moving toward Baengnyeong Island. Another ROK's PKM Division started moving toward the scene.
- At 11:22, the NK's patrol boat continued to move in the direction of the NLL after the unidentified vessel had returned to its area. One ROK's PKM Division with the support from a frigate and two PCCs being maintained, gave warning radio messages twice prior to the NK's patrol boat crossing the NLL.
- At 11:27, the NK's patrol boat crossed the NLL. The ROK Navy 2<sup>nd</sup> Fleet Command gave a warning signal that the South would fire warning shots. The NK's patrol boat ignored the radio message and continued to move in the direction of Daecheong Island.
- Between 11:37 and 11:46, the South's Chamsuri-336 fired three warning shots three times, using a 40mm naval gun in accordance with the instruction of the 2<sup>nd</sup> Fleet Command. The North's patrol boat fired approx. 50 rounds aimed at ROK's Chamsuri-325, which was positioning itself for a response if needed. The ROK's PKM returned immediately in self-defense. The frigate and the PCCs also fired shots in support of the PKM.
- At 11:40, the NK's severely damaged boat retreated north of the NLL.



## Consequences

- One NK's patrol boat was severely damaged with many casualties estimated.
- The ROK's Chamsuri-325 received slight damage, including 23 bullet holes in its body, with no casualties.

## Lessons learned

- The ROK Navy blocked the North's intention to invalidate the NLL and cause tension through purposeful provocative acts. The ROK Navy was able to control this as a result of thorough preparations based on the lessons learned from the 1<sup>st</sup> and 2<sup>nd</sup> Yeonpyeong Naval Campaigns, including a streamlined procedure for coping with the North's intrusions across the NLL and the reinforced firepower of the naval vessels.
- The incident demonstrated that victory in combat requires perpetual readiness, including acquaintance with commanding procedures, training and education aimed to secure absolute superiority over the enemy with tangible/intangible combat strength.

# Attack against the ROKS Cheonan

\* Source: Joint Investigation Report on the Attack against the ROKS Cheonan

## Situation Overview

Republic of Korea Ship Cheonan (PCC) of the 2<sup>nd</sup> Fleet, ROK Navy sank by a North Korean torpedo attack while conducting a normal mission in the vicinity of Baengnyeong Island on Friday, March 26, 2010 at 21:22. This attack resulted in the death of 46 out of 104 crew members, and 58 crew members survived from the incident.

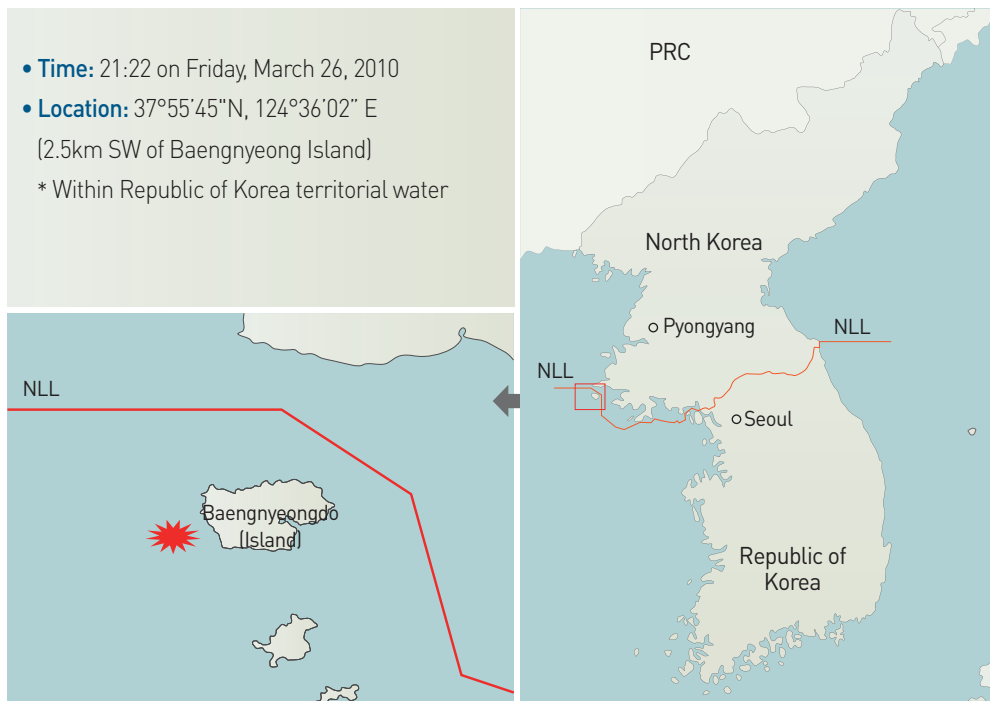

Figure 1. The location of ROKS Cheonan incident

## ROKS Cheonan's Mission

- Tuesday, March 16. Left Pyeongtaek, deployed to Western Baengnyeong Island Patrol Zone.
- Thursday, March 25. Heavy seas warning activated in the West Sea. Left Western Baengnyeong Island Patrol Zone. Averted to SE of Daecheong Island.
- Approximately at 06:00 on Friday, March 26, started to return back to the patrol zone after the inclement weather. Arrived at the patrol zone at about 08:30 and conducted normal operations. At 20:00, there was a duty shift (29 personnel), while others taking a rest or involved in maintenance.

## Situation Development

**| Before the Incident |** Before the incident, there were 7 personnel on the bridge; 7 personnel at the Combat Information Center; 2 personnel at the communication cell; 3 personnel at the bow gun R/S; 7 personnel at the machinery control room; 1 at the harpoon control room; and 2 personnel at the diesel engine room. A total of 29 personnel were on duty while others were on break or sleeping at the mess hall or their berthing. The Commanding Officer (CO) of the ship finished his patrol at about 21:05, returned to the CO's cabin and was checking e-mails, message boards and KNTDS.<sup>1</sup>

At the time of the incident (21:22 on March 26), ROKS Cheonan was carrying out its normal operation.

**| After the Incident |** The 58 survivors stated that they heard loud blasts for 1-2 seconds sounds as they felt an impact in the rear, and a blackout occurred. The influx of seawater to sections of the ship suddenly tilted the ship to the starboard side by 90 degrees. The impact caused the Commanding Officer to be locked inside the CO's cabin. He strapped a fire hose that 4 or 5 crew members had lowered to his waist and escaped to the portside deck. At this time, about 20 crew members had gathered at the deck.

- 21:22 ROKS Cheonan begins to sink (the time of the incident).
- 21:28 2<sup>nd</sup> FLT receives a situation report on the sinking of ROKS Cheonan.
- 21:30 2<sup>nd</sup> FLT orders the immediate departure of 5 PKMs Division in Daecheong Island to the incident location.
- 21:31 2<sup>nd</sup> FLT instructs ROKS Sokcho to sail to the incident location at full speed.
- 21:32 2<sup>nd</sup> FLT requests emergency support to Incheon maritime police (ships 501, 1002) and government ships.
- 21:34 2<sup>nd</sup> FLT activates crisis response element.
- 21:40 2<sup>nd</sup> FLT activates crisis action team and deploys all operation elements for combat.
- 21:47 2<sup>nd</sup> FLT orders deployment of LYNX helicopter in Deokjeok Isl. to Baengnyeong Island.
- 21:56 Arrival of 3 PKMs, commencement of rescue operations
- 21:57 2<sup>nd</sup> FLT declares anti-submarine alert posture.
- 21:59 2<sup>nd</sup> FLT requests Air Force search and rescue support.
- 22:07 2<sup>nd</sup> FLT requests Incheon maritime police RIBs<sup>2</sup> (501, 1002) support.
- 22:10 Additional arrival of 2 PKMs, commencement of rescue operations
- 22:28 Rescue of 1 sailor (Operations officer of ROKS Cheonan) by Chamsuri 322
- 22:41 Arrival of Maritime Police Ship 501 and 2 RIBs, commencement of rescue operations
- 22:50 Commencement of rescue operations by GOV ships (214, 227)
- 23:13 Rescue operations completed, 58 survivors rescued
- 23:13-04:35 March 27 Night search of incident location, transportation of patients

---

**1. KNTDS:** Korea Naval Tactical Data System

**2. RIB** (Rigid-hulled inflatable boat): The bottom section is consisted of glass-fiber stiffened plastic, and the upper section is composed of expandable tube. RIB is light and rigid, allowing for operation in long distance maneuver and high waves in comparison to other small vessels.

When the Commanding Officer looked towards the aft side standing from the bow section of the separated ship, the stack and the stern part aft of the stack were not visible (he also sensed a slight smell of fuel). Seeing that the bow side, where the surviving crew members had gathered, was tilted by 90 degrees to starboard, he took necessary measures. The Commanding Officer first instructed the executive officer (LCDR) to rescue the crew members locked inside the ship and the operations officer (LT) to count the number of crew members and check for a suitable disembarking location once the rescue ships arrived and approached the ship. 6 personnel including a LTJG were instructed to help or carry on their backs the injured personnel, including a PO1 (lumbar fracture), PO1 (fracture of the femoral region), SCPO (bruise on thigh), SCPO (shoulder injury), and SCPO (rib fracture). Following the rescue of all the survivors in the bow, the Commanding Officer confirmed that a total of 58 personnel were present and instructed them to wait for PKMs.

The Commanding Officer had a cell phone conversation with the Squadron Commander, 2<sup>nd</sup> Fleet between 22:32 and 22:42. The key points of the conversation included the following: "It seems that we are hit by something," "What do you think it is?," "It seems like a torpedo, the stern is completely invisible," "Stern? From which part of the stern?" "The stack is not visible. Please send PKMs or RIBs quickly," "What about survivors?" "A total of 58 survivors. Many are bleeding. Two of them are severely wounded and not able to stand up."

**| Situation Report and Dissemination |** At approximately 21:28, the gunnery officer of ROKS Cheonan called the watch officer of 2<sup>nd</sup> Fleet by his cell phone to request rescue (the communication method within the ship was limited from the power outage). The call was forwarded to the chief of the 2<sup>nd</sup> Fleet situation cell, who had heard the content of the conversation. He was told that "the ship is tilted to the right, and we need to be rescued." He utilized a text message information network at 21:30 to order the PKM Division at Daecheong Island to depart immediately to the incident location.

At approximately 21:30, the duty officer at 2<sup>nd</sup> Fleet situation room received a phone call from the combat intelligence officer of ROKS Cheonan with the information that "ROKS Cheonan 'ran aground' in the vicinity of Baengnyeong Island and is sinking. Send help immediately." The duty officer reported the situation to the chief of the situation room. Then, he made a phone call to an Inspector, the deputy chief of the Incheon Maritime Police and said, "I got a phone call that a ROKS ran aground west of Baengnyeong Island. The situation is urgent. Please send Maritime Police Ships 501 and 1002 to the west of Baengnyeong Island."<sup>3</sup>

---

3. Upon the occurrence of the incident, the urgency of the situation led some survivors to use words such as *grounding* instead of using precise terms.

The deputy chief instantly instructed the 501, which was located south of Daecheong Island, and the 1002, which was located south of Socheong Island, to depart for the incident location immediately.

At approximately 21:32, the 2<sup>nd</sup> Fleet liaison officer called the captain of Ship 214, a fishery guide ship of Ongjin county, with his cell phone and said, "ROKS Cheonan is sinking west of Baengnyeong Island. Please send help to support rescue efforts." The captain of the fishery guide ship notified an official at Ongjin county of the incident and set sail at approximately 21:50.

**| Rescue of Crew Members |** All operational elements including ROKN PKMs, maritime police ships, and GOV ships were mobilized to rescue a total of 58 survivors. Around 21:56, 3 PKMs arrived at the incident location and started personnel recovery accompanied by 2 additional PKMs at 22:10. PKM Division connected a wire(3 inches) to ROKS Cheonan. The operation officer of ROKS Cheonan fell into the sea while he was moving between ships and was rescued by PKM.

Considering the possibility that the use of a PKM may increase the rolling of the ship and increase the risk of missteps during the rescue, the Commanding Officer of ROKS Cheonan decided to use maritime police RIBs. Due to the high waves, the wire connected between PKM Division and ROKS Cheonan was untied around 22:38 in order to prevent crew members aboard the bow section of ROKS Cheonan from falling. Two RIBs from Maritime Police Ship 501 (500 tons) arrived around 22:41, approached ROKS Cheonan, and rescued 19 crew members. Ship Incheon 227, a fishery guide ship, rescued 2 wounded crew members and transported them to Baengnyeong Island around 23:08. The remaining 36 survivors were rescued by Maritime Police Ship 501.

Following the arrival of RIBs, the Commanding Officer of ROKS Cheonan ordered personnel gathered by the aft gun to be transported first and ordered that "the wounded go first and help the severely wounded." In accordance with the Commanding Officer's orders, the wounded and seaman apprentices were rescued first and moved to Maritime Police Ship 501 with RIBs and rescue boards. The Commanding Officer, executive officer, and communication officer were the last to leave ROKS Cheonan. Between 23:13 March 26 and 04:35 March 27, the incident location was searched, and the 51 survivors aboard Maritime Police Ship 501 were transported to PKM Divisions and then moved to PCC. They arrived at Pyeongtaek port at approximately 14:00 March 27.

## Investigation Activities

**| Joint Investigation Group (JIG) operations |** The CIV-MIL JIG was initially organized on March 31 and included 82 personnel (59 active service members, 17 government personnel, and 6 civilians). It was then reorganized as the Civilian-Military Joint Investigation Group on April 12 and included 73 personnel (49 ROK, 24 Foreign experts), to initiate investigation activities.

**Figure 2. The organizational structure of the Joint Investigation Group (JIG)**

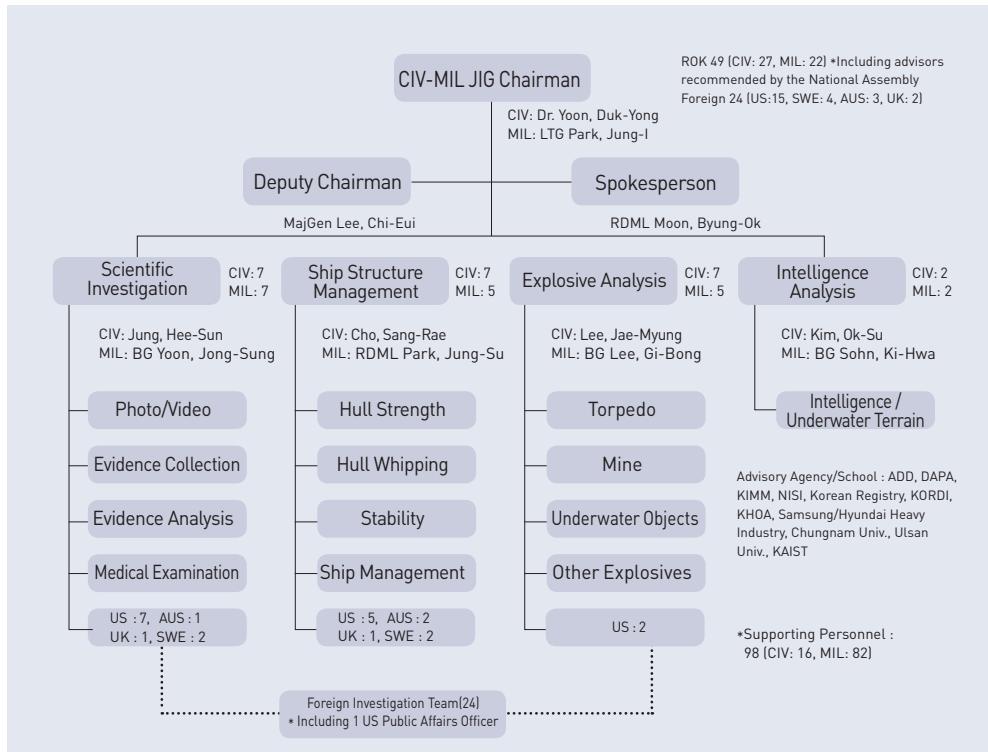

The JIG was in operation for a total of 92 days until June 30. During this time, it held press conferences on its investigation activities on four different occasions (April 7, 15, 25, and May 20) and also attended a UN Security Council meeting for 9 days from June 9 through June 17 to explain the investigation results.

The objective of the JIG was to find the exact cause of the sinking through a detailed investigation conducted in a scientific and objective manner. The focus was first, to form a civilian and military joint investigation group in order to improve the transparency and credibility of the investigation process; second, to secure international credibility through the participation of foreign experts from the US and other nations; third, to conduct the investigation in phases, with the recovery of the ship as the dividing point; and fourth, to conduct the investigation in a scientific and systematic manner.

**| Progress | Prior to the Recovery of the Ship: March 31-April 14** Prior to the recovery of the ship, each team of the JIG closely reviewed the operational timeline and actions of ROKS Cheonan. The JIG recruited personnel from the private sector and concurrently held discussions with relevant experts. Internal and external factors were both considered as a possible cause of the sinking. As for the internal factors of the sinking, the analysis conducted by the ADD indicated that fatigue fracture was highly unlikely. The summary of the maintenance records also indicated that the possibility of maintenance failure causing the sinking was very slim as well. In addition, a fuel tank explosion was assessed to be highly unlikely, because such an explosion would not satisfy the necessary conditions for the splitting of the ship.

As for the external factors of the sinking, the possibility of friendly mines was found to be limited whereas an explosion of North Korean torpedoes and mines, on the other hand, was assessed to be possible, according to the expert opinions and assessment by the JIG. There were no reefs on the sea charts of the incident location, and according to expert opinions, chopping waves would be highly unlikely to cause the sinking. In addition, radar records and TOD imagery taken at the observation posts near the spot of the incident showed no other ships, indicating that sinking by a collision was highly unlikely as well.

An examination of key materials such as the clothes of the survivors (9 items including service uniforms) found no explosive residue. In addition, the recovered items (3 items including MCR floor plate) from the surface and coast of Baengnyeong Island also showed no trace of fire.

**After the Recovery of the Stern: April 15-April 23** During the recovery of the stern, the JIG organized an on-site investigation team of 57 personnel, which was deployed to ROKS Dokdo on April 14. The stern was recovered on April 15, and the on-site investigation results following the recovery of the stern were announced on April 16.

The preliminary on-site investigation led to the assessment that an internal explosion causing the sinking was highly unlikely. This assessment was based on the lack of burn damage on the interior structure, the good condition of the wires, and the upward deformation of the hull bottom plating.

Grounding was also assessed to be highly unlikely given that the hull bottom was found in relatively good condition and that the fractured surface on the bottom of the stern was bent in an upward direction.

Fatigue fracture was assessed to be highly unlikely given that the fractured surface of the hull bottom was bent upward with an 80° angle and that the stiffeners located at the after bulkhead of the gas turbine room were rolled up.

Therefore, it was concluded that an external explosion was the most likely possibility given that the hull fracture occurred from the port bottom toward the starboard side in an upward direction; no trace of fragments was found at the fractured surface; the bending of the hull was caused by external pressure; and the wires were cut and not melted by heat. An examination of the collected evidence

from the scene, which consisted of 10 samples including interior materials from the fractured surface, was conducted to detect explosive residue and aluminum components.

A detailed examination of the stern was conducted on April 18. At this time, 147 samples of 29 types were collected. A 3-dimensional laser scan of the fractured stern was performed on April 21. The DTaQ took precise measurements of the damaged parts of the stern and conducted an investigation of the damaged locations and deformations. The onsite investigation during the recovery of the stern, and the detailed investigation following the recovery of the stern, which was conducted from April 15 to 25, led to the assessment that an external explosion was more likely than an internal explosion.

**After the Recovery of the Bow: April 24-May 19** The JIG sent an on-site investigation team of 50 personnel to Baengnyeong Island on April 23 for investigative activities following the recovery of the bow. The bow was recovered on April 24, and the investigation results of the bow were announced on April 25. The second on-site investigation led to the assessment that the possibility of an internal explosion was highly unlikely given the intact magazines and fuel tanks, inward bending of the hull at the fractured surface, upward rolling of ribs and upward bending of the CVK.

A grounding was confirmed to be highly unlikely given that the hull bottom was found in good condition and the sonar dome located at the hull bottom did not show any damage.

Fatigue fracture was confirmed to be highly unlikely given the nature of the deformation: the fractured surface was significantly deformed in an upward direction due to external pressure, and complicated damage was delivered to ROKS Cheonan.

Among the factors of an external explosion, a contact explosion was assessed to be unlikely given the lack of soot within and outside the hull. Furthermore, there were no holes or traces of melting due to heat on the wires and interior materials at the fractured surface.

Therefore, the possibility of a non-contact external explosion was assessed to be highly likely based on the severe inward bending and severance of the hull due to shockwave and bubble effect generated by an underwater explosion.

The on-site investigation results indicated that the explosion occurred at the port of the gas turbine room centerline with pressure being exerted upward toward the starboard side. The size of the explosive charge was estimated through a simulation that took into account the size and shape of the damage seen.

A three-dimensional laser scanning was conducted on the fractured surface of the bow. A discussion on an underwater explosion hull whipping analysis by the US team was conducted on April 26. The on-site investigation during the recovery of the bow and the detailed investigation following the recovery of the bow, which was conducted from April 23 to May 19, led to the assessment that an underwater explosion occurred and that a non-contact explosion was more likely than a contact explosion.

**The Recovery of the Torpedo Propulsion Motor: May 15** The propulsion motor and propellers of a



torpedo propulsion system were recovered on May 15, during a detailed search of the seabed using a special net that began on May 10.

An analysis of the torpedo propulsion section confirmed that the recovered evidence was identical in size and shape to the schematics of a North Korean torpedo. Furthermore, the JIG was able to confirm through composition analysis that the adhered materials found on the torpedo propulsion section and ROKS Cheonan were identical. In addition, the Korean alphabet inscription in the rear of the propulsion section (“1 beon” or Number 1 in English) is similar in style with the Korean alphabet inscription method on a North Korean torpedo (“4 ho”, unit 4 in English) obtained in 2003 near waters in the vicinity of Pohang.

Figure 3. Rear section of torpedo



Figure 4. Marking on North Korean test torpedo

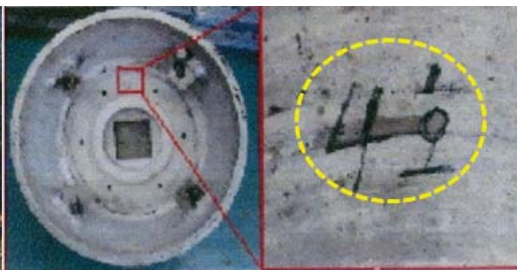

Figure 5. CHT-02D torpedo manufactured by North Korea



**Press Conference on Investigation Result: May 20** During a press conference at the MND conference room with members of the local and foreign press corps in presence, Dr. Yoon Duk Yong (Civilian Co-chairman) announced the investigation result.

After taking the entirety of the analysis results of Korean and foreign experts on the following factors into consideration – the torpedo propulsion system recovered from the incident location, deformation of the hull, statements by related personnel, medical examination of the deceased and wounded service members, seismic and air acoustic waves, simulations of underwater explosions, tidal currents in the vicinity of Baengnyeong Island, and analysis of explosive components – the JIG confirmed the following:

---

**4. Sonar dome:** The cover for the sonar that consists of special material to allow the transmission of the sound waves

ROKS Cheonan was split and sunk due to shockwave and bubble effect generated by the underwater explosion of a torpedo. The detonation location was 3m to the port from the center of the gas turbine room and at a depth of 6~9m. The weapon system used was a CHT-02D torpedo with roughly 250kg of explosives made by North Korea.

## Conclusion

ROKS Cheonan was sunk by a North Korean torpedo attack while conducting its normal mission in vicinity of Baengnyeong Island at 21:22 hours on March 26, 2010. Immediately following the sinking of the ship, the ROK military conducted a surface, coastal and underwater search until April 3, and transitioned from a personnel recovery operation to a salvaging operation on April 4.

The salvage and transportation of the separated bow and stern section were completed on April 25. During the salvage of the ship, 40 bodies were recovered as well. Following the salvage of the ship, emphasis was placed on search operations and a detailed search was conducted focusing on the areas where the likelihood of collecting debris was assessed to be the highest. A detailed search of the seabed using special nets commenced on May 10 and parts of a torpedo propulsion section, including a propulsion motor and propellers, were recovered on May 15.

The analysis on the cause of the sinking initially left open every possibility and explored the possibilities of a non-explosion, internal explosion or external explosion for causing the sinking. However, a detailed investigation following the salvage of the ship eliminated the possibilities of a non-explosion and internal explosion, leading the JIG to conclude that an external explosion, and more specifically an underwater explosion, was the most likely cause behind the sinking.

Figure 6. 3D laser scan image of the fractured bow and stern

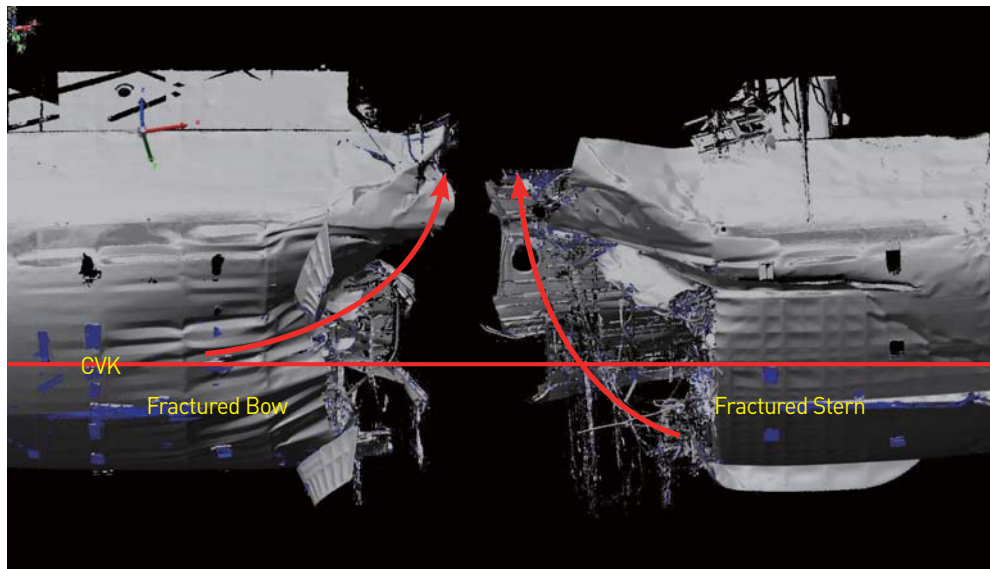

The possibility of a non-contact torpedo generating an underwater explosion was assessed to have the highest likelihood and the possibility of a moored mine was not ruled out despite its low likelihood.

The basis of our assessment that a torpedo attack caused the sinking is as follows:

First, precise measurement and analysis of the damaged hull showed that a shockwave and bubble effect caused significant upward bending of the Center Vertical Keel compared to its original state. The shell plating was steeply bent with parts of the ship fragmented. On the main deck, fractures occurred along the large openings used for the maintenance of equipment in the gas turbine room and the portside was deformed significantly in an upward direction. The bulkhead of the gas turbine room was significantly damaged and deformed. The upward bending of the bottom of the stern and bow proves that an underwater explosion occurred.

Second, a thorough investigation of the interior and exterior of the ship found evidence of extreme pressure on the fin stabilizer (which prevents significant rolling of the ship); traces of high water pressure and bubble effect on the bottom of the hull; and wires cut with no traces of heat; and traces of spherical pressure on the gas turbine room. The above indicate that a strong shockwave and bubble effect caused the splitting and sinking of the ship.

Figure 7. Traces of shockwave and bubble effect



Pressure on the stabilizer

Pressure & bubble effect

Wires cut clean with no trace of heat

Trace of spherical pressure

Third, the JIG analyzed statements made by survivors that they heard a near simultaneous explosion once or twice and water was splashed on the face of the port lookout who fell from the impact. Furthermore, the statements were made by coastal sentries on Baengnyeong Island that they saw a 100-meter high pillar of white flash for 2-3 seconds. The analysis of these testimonies indicated that the aforementioned phenomena are consistent with the occurrence of a water plume resulting from a shockwave and bubble effect. Also, no traces of fragmentation or burn injury were found from our examination of the wounded survivors and the deceased service members, while fractures and lacerations were observed. These observations are consistent with phenomena resulting from a shockwave and bubble effect.

Fourth, the seismic and air acoustic wave analysis conducted by the Korea Institute of Geoscience and Mineral Resources (KIGAM) showed the following. A seismic wave of magnitude 1.5 was detected at 4 stations. Two air acoustic waves with a 1.1 second interval were detected at 11 stations. The seismic and air acoustic waves originated from an identical site of explosion. All these are consistent

with the phenomena that arise from a shockwave and bubble effect produced by an underwater explosion.

Fifth, the 1<sup>st</sup> analysis result by US team, from the hull deformation showed that the possible explosion type is an explosion of TNT equivalent of 200-300kg charge size at a point of 3m to the port from the central bottom of the gas turbine room, and at a depth of 6-9m. 2<sup>nd</sup> analysis result on simulation, by the ROK, resulted in the identical location, with TNT equivalent 250-360kg charge size. The efforts on this was also supported by the UK Investigation Team.

Sixth, based on the analysis of tidal currents in the vicinity of Baengnyeong Island, the JIG determined that although the currents would have had a minimal influence on the launch of a torpedo, they were strong enough to limit the emplacement of mines.

Seventh, analysis of the explosive residue found HMX from 28 locations including the stack and fractured surface; RDX from 6 locations including the stack and seabed; and traces of TNT from 2 locations including the fin stabilizer. Based on this analysis, the use of an explosive compound containing HMX, RDX, and TNT was confirmed.

Lastly, on May 15, 2010, the JIG recovered conclusive evidence that confirmed the use of a torpedo while conducting a detailed search in the vicinity of the incident location using special nets. The conclusive evidence was a torpedo propulsion motor system including propellers, a propulsion motor and steering section. The evidence is consistent in its size and design to the torpedo schematics included in an introductory brochure produced by North Korea for export purposes.

Figure 8. Schematic of torpedo and recovered rear section of torpedo

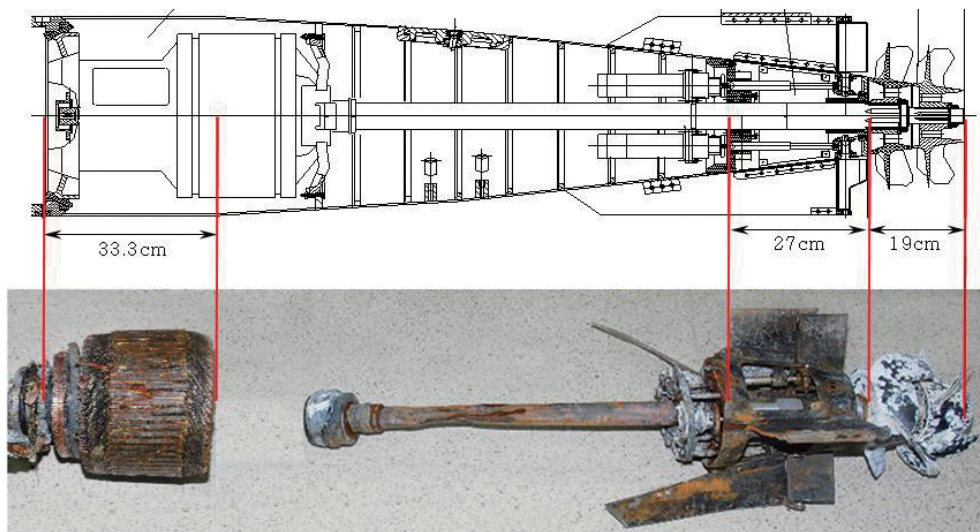

A composition analysis of the adhered materials from ROKS Cheonan showed that the materials are identical to that found on the rear section of the torpedo. The Korean marking '1beon(No. 1 in English)' inside the rear section of the propulsion system is also consistent with the marking of a North Korea test torpedo obtained in 2003. The above evidence confirm that the recovered torpedo parts were manufactured by North Korea.

In conclusion, taking the entirety of the analysis results of the CIV-MIL Joint Investigation Group and Multinational Combined Intelligence TF on the following factors into consideration – the torpedo propulsion system recovered from the incident location, deformation of the hull, statements by related personnel, medical examination of the deceased and wounded service members, seismic and infrasound waves, simulations of underwater explosions, tidal currents in vicinity of Baengnyeong Island, analysis of explosive components, recovered torpedo parts, and the identification of the perpetrator – the JIG and MCITF concluded the following:

ROKS Cheonan was split and sunk due to shockwave and bubble effect generated by the underwater explosion of a torpedo. The detonation location was 3m to port from the center of the gas turbine room and at a depth of 6~9m. The weapon system used was a CHT-02D torpedo with approximately 250kg of explosives manufactured and used by North Korea.

## Overall Shape and Structures of ROKS Cheonan

ROKS Cheonan was constructed by Korea TACOMA Marine Ind.(merged with Hanjin Heavy Ind. & Construction Holdings CO. in 1999), and after its acquisition to ROK Navy in 1988, it had been in operation for approximately 22 years before the incident.

ROKS Cheonan consisted of O-1 deck and O-2 deck above the main deck, and of 1<sup>st</sup> Platform and 2<sup>nd</sup> Platform below the main deck. On the main deck, from the bow-side to stern-side there were a ward room, officers' berthing, CPOs' mess, machinery control room and crew's mess. The CO's cabin, Combat Information Center, communication room, demist,<sup>5</sup> and stack<sup>6</sup> are located on the O-1 deck. The bridge and mast<sup>7</sup> are located on the O-2 deck. On the bow-side of the 1<sup>st</sup> Platform, there are a deck admin room, sail/gunnery/operation crews' berthing, and CPOs' berthing. The machinery crews' berthing, CPOs' lounge, aft head, decontamination room, machinery storage, stern gun R/S, and steering gear room are located on the stern-side. On the 2<sup>nd</sup> Platform, firearms admin room, elec. maintenance room, and gyro room are located on the bow-side, and the gas turbine room and diesel engine room are on the stern-side. On the ship bottom, a sonar dome, fin stabilizer, and bilge keel<sup>8</sup> are located.

Figure 9. Overall shape and structures of ROKS Cheonan



5. A demist is a device which inhales air that the engine needs and excludes moisture and dust.
6. A stack is a chimney which acts as an exhaust part of an engine.
7. A mast is located at the center of a ship.
8. A bilge keel is located on the left and right side of a ship bottom mitigating blurring of a ship.

## Artillery Firing at Yeonpyeongdo (Island)

### Outline

Around 14:34, on November 23, 2010, the North's military (Korean People's Army: KPA) fired 170 artillery shots at Yeonpyeong Island, South Korea. In response to this attack, the Yeonpyeong unit of the ROK Marine Corps immediately returned fire against the North using K-9 self-propelled artillery. Such illegitimate and inhumane provocation by the North, which was aimed at a civilian residential area as well as the ROK marine base, resulted in the deaths of two civilians and two ROK marines and many other civilians and marines being severely or slightly injured.

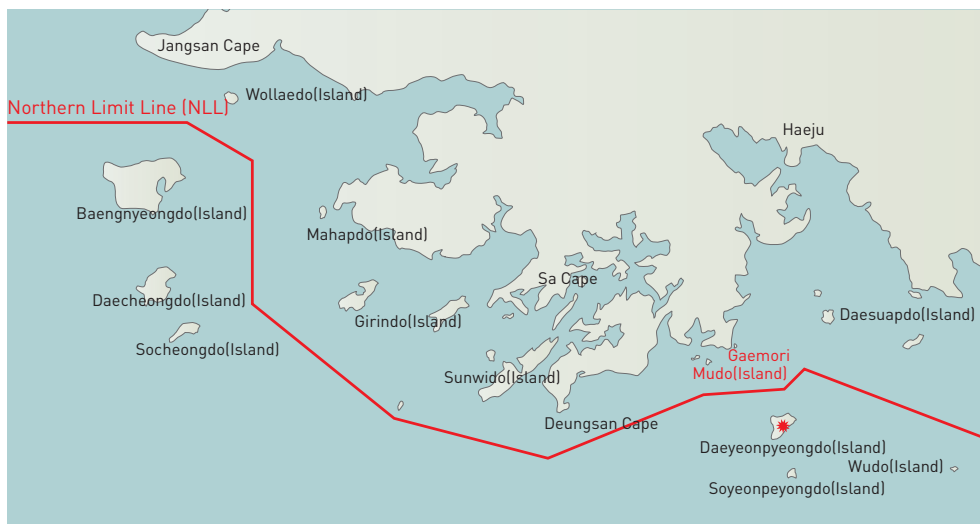

### Development of the operation

- Between 10:15 and 14:30 on November 23, 2010, the Yeonpyeong unit carried out a regular maritime shooting training exercise in the ROK Maritime Firing Zone, south of the Northern Limit Line (NLL).
- Between 14:34 and 14:46, the KPA indiscriminately fired multiple rocket launchers (MRL) located on Gaemori coast and its coastal artillery guns on Mudo (Island), North Korea, at the ROK marine base (Yeonpyeong unit) and civilian residences. Sixty out of around 150 shots from the MRL and the coastal artillery launcher bombarded the ROK base and civilian residences on Yeonpyeong Island. The other 90 shots fell into the sea.
- Between 14:47 and 15:15, and after issuing a warning to the North twice, the Yeonpyeong unit responded

to this attack by firing 50 rounds of its K-9 self-propelled artillery at the North's coastal artillery base.

-Between 15:12 and 15:29, the KPA carried out a second attack – this time on the Command Post of the Yeonpyeong unit and the ROK radar base - by firing 20 rounds from its MRLs and coastal artillery.

-Between 15:25 and 15:41, in response to the North's second attack, the Yeonpyeong unit responded by firing 30 rounds from its K-9 self-propelled artillery at the North's coastal artillery position on the Gaemori coast.

## Consequences

- The KPA is assumed to be severely damaged by the concentrated firing by the ROK.

- Two ROK marines and two civilians perished while 16 others were wounded, including some severely injured. In addition, a total of 133 buildings (33 completely destroyed, 9 half destroyed, and 91 partially destroyed) and power and communications facilities were damaged. Wildfires broke out at ten sites.

## Lessons learned

- The North's firing of artillery at Yeonpyeong Island was the first direct attack aimed at ROK territory since the end of the Korean War, which suggests the possible elevation of provocative actions from the North. In that regard, the incident led the ROK to reassess its need for further exhaustive military preparedness against the North.

- The incident reaffirmed that North Korea is a regime that is not afraid to perpetuate any type of provocation, even including indiscriminately firing at civilian residences and violating international laws, such as the UN Charter and the Armistice Agreement, to achieve its purpose.



Following surprise bombardment by the North, ROK marines of the Yeonpyeong unit prepare to counter-attack using K-9 self-propelled artillery (Yeonpyeong Island, November 23, 2010).



# Status of Neighboring Countries' Military Strength

\* Source: Relevant materials, including the Military Balance 2010, International Institution for Strategic Studies (IISS) in the UK, February 2010

## Number of Troops

Classification	U.S.	Russia	China	Japan
Army	553,044	360,000	1,600,000	140,251
Navy	329,390	142,000	255,000	42,431
Air Force	334,342	160,000	330,000	43,652
Others	Marine Corps 198,513 Coast Guard 43,598	Airborne 35,000 Strategic 80,000 Command /Support 250,000	2 <sup>nd</sup> Artillery 10,000	Joint Staff 2,202
Total	1,458,887	1,027,000	2,285,000	228,536

## Army

Classification	U.S.	Russia	China	Japan
Divisions	10	6	60	9
Tanks	5,850	23,000	6,550	880
Light tanks	0	150	1,000	0
Infantry combat vehicles	6,452	15,180	1,140	70
Recon tanks	96	2,000	800	100
Armored vehicles	19,637	9,900	3,300	960
Towed artillery	1,780	12,765	14,000	420
Self-propelled artillery	1,594	6,010	1,280	230
Multiple launch rocket systems	830	3,976	2,400	100
Mortar	2,066	2,550	150	2,020
Anti-tank guided weapons	SP 2,005 Portable 19,950	0	SP 24 Portable 7,176	SP 56 Portable 1,273
Ground-to-air missiles	1,281	2,465	290	640
Helicopters	3,877	1,278	499	458
Aircraft	314	0	0	20

\* SP: Self-propelled

## Navy

Classification	U.S.	Russia	China	Japan
Submarines	71	66	65	16
Strategic nuclear submarines	14	14	3	0
Aircraft carriers	11	1	0	0
Cruisers	22	5	0	0
Destroyers	56	14	28	44
Frigates	21	14	52	8
Patrol and coastal combatants	18	98	253	7
Mine sweepers	9	37	69	30
Amphibious ships	31	23	83	5
Amphibious craft	269	19	160	8
Support & Aux. ships	291	105	182	30
Fighters	900	259	290	0
Helicopters	512	250	78	108
Marine Corps divisions	3	1 (3 Brigades)	(2 Brigades)	0
Marine Corps	Tanks: 403 Armored vehicles: 1,563 Towed guns: 1,282 Mortar: 585 Anti-tank weapons: 2,299 UAVs: 1,072, Aircrafts : 371 Helicopters: 573	Included in Navy	Included in Navy	No Marine Corps

## Air Force

Classification	U.S.	Russia	China	Japan
Strategic bombers	154	205	0	0
Bombers	0	807	365	0
Recon. aircraft	106	119	120	13
Command and Control aircraft	37	0	0	0
Fighters	2,650	725	1,100	359
Transport aircraft	844	293	296	42
Tankers	512	20	18	4
AWACS	17	20	13	17
Trainers	1,141	1,072	522	270
Helicopters	167	60	80	49
Civil Reserve Air Fleet	1,413	0	0	0

## Comparison between Major countries' Defense Budgets

(As of 2009)

Country	GDP (USD billions)	Defense Budget (USD billions)	Defense Budget-GDP Ratio (%)	Troops (Unit: 1,000)	Per-capita defense budget (USD)
ROK	882	24.5	2.8	650	505
U.S.	13,800	690.3	5.0	1,459	2,270
Japan	5,300	45.6	0.9	229	359
China	4,860	78.0	1.6	2,285	58
Russia	1,370	41.1	3.0	1,027	293
Taiwan	349	9.7	2.8	290	425
UK	2,670	60.8	2.3	175	998
France	2,860	67.2	1.3	353	1,049
Germany	3,650	46.9	1.3	251	570
Israel	198	12.9	6.5	177	1,791
Egypt	157	4.6	2.9	469	59
Saudi Arabia	410	41.2	10.0	234	1,436
Australia	1,119	27.6	2.5	55	1,298
Turkey	731	13.5	1.9	511	179
Malaysia	222	4.4	2.0	109	173
Thailand	259	5.1	2.0	306	78
Singapore	170	8.2	4.8	73	1,767
Canada	1,470	20.2	1.4	65	603

\* Source: Relevant materials, including the Military Balance 2010, International Institution for Strategic Studies (IISS) in the UK, February 2010

\* Those for the UK, France, Germany, Turkey, Egypt, and Malaysia are 2008 figures.

## Comparison of the Military Strength of the Two Koreas

(As of November 2010)

Classification		South Korea	North Korea		
Troops (in peace time)	Army	520,000	1,020,000		
	Navy	68,000 (including 27,000 Marine Corps troops)	60,000		
	Air Force	65,000	110,000		
	Total	650,000	1,190,000		
Major combat strength	Army	Units	Corps(level)	10 (including Special Warfare Command)	15
			Division	46 (including Marine Corps)	90
			Mobile brigade	14 (including Marine Corps)	70(not including 10 Reserve Training Units)
		Equipment	Tanks	2,400 (including Marine Corps)	4,100
			Armored vehicles	2,600 (including Marine Corps)	2,100
			Field artillery	5,200 (including Marine Corps)	8,500
			MLRS/MRL	200	5,100
	Ground-to-ground missiles	30 launchers	100 launchers		
	Navy	Surface ships	Combatants	120	420
			Amphibious ships (LST/LSM)	10	260
			Mine warfare vessels	10	30
			Support & Aux. vessels	20	30
		Submarines	10	70	
	Air Force	Combat aircraft	460	820	
		Surveillance&Reconnaissance	50 (including those belonging to the Navy)	30	
		Transport aircraft	40	330	
		Trainers	180	170	
	Helicopters (Army/Navy/Air Force)		680	300	
	Reserve troops		3.2 million	7.7 million (including Reserve Military Training Unit, Worker and Peasant Red Guard, and Red Youth Guard)	

\* The number of units and equipment of the Army include those of the Marine Corps to compare military strength between the two Koreas.

\* North Korean Army field artillery numbers do not include 76.2mm guns deployed at the regiment level.

\* The table above provides quantitative comparisons for public discretion as qualitative assessments are limited.

## Comparison of the Economic Indicators of the Two Koreas

Classification	South Korea		North Korea		Comparison	
	2008	2009	2008	2009	2008	2009
GNI (USD billions)	934.7	837.2	24.8	22.4	South's GNI 37.7 times higher	South's GNI 37.7 times higher
Per-capital GNI (USD)	19,227	17,173	970.4	960	South's 19.8 times higher	South's 17.9 times higher
Economic growth rate (%) * Based on GNI	2.3	0.2	3.1	-0.9	-	-
Trade volume (USD billions)	857.3	686.6	3.82	3.41	South's 224.4 times higher	South's 201.4 times higher
Total population (Unit: millions)	48.60	48.75	23.30	23.38	South's 2.1 times higher	South's 2.1 times higher

\* Source: Bank of Korea

- GNI (Gross National Income): in 1993, major countries and international organizations (such as the UN and IMF) replaced GNP with this measurement.

## Negotiation Process in North Korea's Nuclear Programs

Chronology	Major Developments
2005 January 29	U.S. State Department spokesman Richard Boucher clearly states U.S. position at regular press briefing: - U.S. ready to soon resume Six-Party Talks with no preconditions
February 10	North Korean Foreign Ministry announces North's possession of nuclear weapons and its interminable withdrawal from Six-Party Talks.
February 21	Kim Jong Il, Chairman of the National Defense Commission, meets Wang Jiarui, Minister of International Department of the Central Committee of the Communist Party of China - Kim supports principle of denuclearization of Korean Peninsula and identification of peaceful solutions to problems through dialogue. - Kim denies opposition to Six-Party Talks and expressed commitment to their success.
March 23	Chinese President Hu Jintao offers three principles (below) concerning North's nuclear program at a meeting with North Korean Prime Minister Park Bong-joo. - ① Denuclearization of Korean Peninsula, ② North's reasonable solutions to matters of common interest and ③ Peace and stability are a matter of common interest
March 30	Former Assistant Secretary of State Robert Gallucci addresses that the U.S. may take military actions against North Korea once the nuclear material is exported.

Chronology	Major Developments
May 11	North Korean Foreign Ministry claims North has completed work to withdraw spent fuel rods.
June 10	At a summit ROK and U.S. leaders agree to promote improvement in U.S.-DPRK relations, if North Korea dismantles its nuclear program.
June 17	In meeting with ROK presidential envoy Chung Dong-young, Kim Jong Il indicates that North would return to Six-Party Talks if U.S. establishes diplomatic relations with North.
July 12	Chung Dong-young, ROK Unification Minister, announces 'important proposal to the North.' -Supply of 2 million kW of power in exchange for North agreeing to scrap its nuclear programs
July 26-August 7	First session of the Fourth Round of Six-Party Talks commences.
September 15	U.S. Treasury Department freezes North Korean accounts in Macau bank BDA.
September 13-19	Second session of the Fourth Round of Six-Party Talks held, adopting September 19 Joint Statement.
October 24	North Korean Foreign Ministry announces it would participate in Six-Party Talks in early November.
November 9-11	First session of the Fifth Round of Six-Party Talks held.
December 2	North Korean Foreign Ministry requests urgent bilateral meeting with U.S. to discuss lifting financial sanctions against North.
2006 January 18	Christopher Hill of U.S. and Kim Gye-gwan of North meet and agree on need for early resumption of Six-Party Talks.
March 7	Representatives of U.S. and North meet in New York. The North repeats its position that it would not participate in Six-Party Talks unless measures are taken to unfreeze its BDA accounts.
April 27-28	Kim Jong Il tells Tang Jiaxuan of China that North would not return to Six-Party Talks until its BDA accounts are unfrozen.
June 19	Condoleezza Rice, U.S. Secretary of State, issues a warning against North's preparation to launch long-range missile. Rice declares that launch of long-range missile by North would violate its moratorium obligation contained in the September 19 Joint Statement and be regarded as act of clear provocation.
July 5	North fires total of seven long-range missiles, including a Daepodong 2 missile.
July 15	UN Security Council unanimously passes Resolution 1695.
July 25	U.S. Senate unanimously passes the North Korea Non-Proliferation Act.
September 13	International Relations Committee of U.S. House of Representatives unanimously passes the North Korea Non-Proliferation Act .
September 15	Leaders of ROK and U.S. agree to make joint efforts for comprehensive approach to North Korea at Summit.
October 3	North Korean Foreign Ministry announces North's intention to carry out 'nuclear test.'
October 5	Wang Guangya, Chinese Ambassador to UN, openly warns that "a nuclear test by the North will result in serious repercussions."
October 6	UN Security Council issues presidential statement urging North to "abandon its plans" for nuclear test.
October 9	North's Korean Central News Agency (KCNA) announces "a successful nuclear test."
October 11	North Korean Foreign Ministry hints additional nuclear tests.

Chronology	Major Developments
October 14	UN Security Council adopts Resolution 1718: <ul style="list-style-type: none"> <li>- Ban on the provision of materials and technology related to WMDs (such as nuclear weapons and ballistic missiles) to North</li> <li>-Ban on export of luxurious goods to the North</li> <li>-Blocking transfer of WMD-related funds to North and banning pertinent people from visiting the North</li> <li>-Searching cargo to prevent transfer of WMDs</li> </ul>
October 18-19	Tang Jiaxuan of China visits the North and comments on its plan for additional nuclear tests. <ul style="list-style-type: none"> <li>-Kim Jong Il reveals that the North has no plans for additional nuclear tests but would not condone U.S. pressure.</li> </ul>
October 31	Chinese Foreign Ministry announces resumption of Six-Party Talks after informal tripartite meeting (between U.S.-China-North Korea) in Beijing.
November 1	North Korean Foreign Ministry announces it would return to Six-Party Talks if imposed financial sanctions on it were discussed and settled.
November 28-29	Six-Party Talks senior representatives of the U.S. and North met in Beijing. <ul style="list-style-type: none"> <li>-U.S. suggests North to take initial actions</li> </ul>
December 18-22	Second session of the Fifth Round of the Six-Party Talks convenes at Diaoyutai State Guesthouse in Beijing. <ul style="list-style-type: none"> <li>-North strongly calls for nuclear armament reduction talks (December 18).</li> <li>-Representatives discuss concrete initial actions, since North insists on first settling the matter of its frozen BDA account.</li> </ul>
2007 January 16-18	Representatives of the U.S. and North (Christopher Hill and Kim Gye-gwan) meet in Berlin. <ul style="list-style-type: none"> <li>-Meetings are held at each country's embassy.</li> <li>-Working-level discussions about freeze of North's BDA account and resumption of Six-Party Talks.</li> </ul>
February 8-13	Third session of the Fifth Round of Six-Party Talks is held at the Diaoyutai State Guesthouse in Beijing. <ul style="list-style-type: none"> <li>-Outcome of the Berlin meetings between U.S. and North explained</li> <li>-Appropriate initial actions and establishment of five working-level groups discussed</li> </ul>
February 13	Six parties agree to initial actions for implementation of the September 19 Joint Statement ("February 13 Agreement"): <ul style="list-style-type: none"> <li>-Implement initial actions within 60 days</li> <li>-Establish working groups to implement initial actions</li> <li>-Discuss Sixth Round of Six-Party Talks and Six-Party Ministerial Meeting and measures to be taken in following phase</li> </ul>
March 5-6	U.S. and North hold a working-group meeting for normalization of relations in New York. <ul style="list-style-type: none"> <li>-The North promises to close and seal its nuclear facilities following settlement of BDA account issue, receipt of 50,000 tons of heavy fuel oil (HFO), and the IAEA Director General's visit to the North (March 13~ 14).</li> <li>-The Nuclear weapons issue should be discussed at the final phase of negotiations in consideration of the fact that relations between the North and U.S. are hostile.</li> </ul>
March 6-7	Japan and North hold a working-group meeting for normalization of relations in Hanoi, Vietnam. <ul style="list-style-type: none"> <li>-Japan insists on settling problem concerning abduction of its people by the North, while the North insists on settling colonial history-related issues.</li> </ul>
March 15	First working-group meeting on Economic and Energy Cooperation convenes at Korean Embassy in Beijing. <ul style="list-style-type: none"> <li>-ROK and U.S. reaffirm willingness to provide initial energy to the North. The North explains status of its energy needs.</li> </ul>
March 16	Northeast Asia Peace and Security Mechanism Working Group (NEAPSM) meets at Russian Embassy in Beijing. <ul style="list-style-type: none"> <li>-Each country expresses its view on establishment of trust in region.</li> </ul>

Chronology	Major Developments
March 17-18	Working group meeting on Denuclearization of Korean Peninsula convenes at Diaoyutai State Guesthouse in Beijing. -Discussions about implementing measures in initial and ensuing phases and IAEA activities
March 19-22	First session of Sixth Round of Six-Party Talks at Diaoyutai State Guesthouse in Beijing -Adjourned without substantial discussion due to issue of North's BDA account
March 14-June 13	Issue concerning North's BDA account settled -North asks for remittance of a total \$23 million in 40-plus BDA accounts to its account in Russian Commercial Bank. -North officially confirms settlement of BDA issue.
June 26-30	Group of working-level IAEA representatives (4 people, including Director General) visit the North. -Discussions about how to supervise and verify closure and sealing of five nuclear facilities in the North
July 12-August 2	ROK supplies 50,000 tons of heavy fuel oil to the North as part of implementation of initial actions.
July 14-August 11	10-member IAEA supervision and verification team visits the North to verify closure and sealing of its nuclear facilities and to oversee installation of surveillance cameras.
July 18-20	Senior representatives to Six-Party Talks meet in Beijing, China. -Confirmation of North's intention/position concerning its report on, and disablement of, its nuclear facilities and supply of 950,000 tons of heavy fuel oil -Discussions about holding meetings of five working groups by the end of August and following round of Six-Party Talks and foreign ministers' meeting
August 7-8	Second working-group meeting on Economic and Energy Cooperation convenes at Panmunjom. -Discussions about how to supply 950,000 tons of heavy fuel oil in next phase -Supply of 50,000 tons of heavy fuel oil on monthly basis -Supply of energy-related facilities and materials for equivalent of 500,000 tons of heavy fuel oil
August 16-17	At Second Denuclearization of Korean Peninsula working-group meeting (in Shenyang, China), the North offers its basic position on report on, and disablement of, its nuclear facilities. -Subject to report: nuclear facilities, materials, and UEP (Uranium Enrichment Project) included; nuclear detonation device not included -Subject to disablement: 5MWe nuclear reactor, reprocessing facilities, fuel rod production factories
August 20-21	Second Northeast Asia Peace and Security Mechanism working-group convenes in Moscow. -Each country expresses its opinion on issues of setting principles for security cooperation and promoting establishment of trust in Northeast Asia.
September 1-2	Second Normalization of DPRK-US relations working-group convenes in Geneva. -Agreements on North declaring and disabling its nuclear facilities and U.S. lifting sanctions placed on the North within a year
September 5-6	Second Normalization of DPRK-Japan relations working-group meeting convenes in Ulan Bator, Mongolia. -Agreement to continue discussions about pending issues, including the North's abduction of Japanese citizens
September 11-15	American, Russian and Chinese nuclear experts visit nuclear facility in Yongbyon, North Korea. -Their findings go into a report for Six-Party Talks that covers discussions with the North about technological problems and expenses required for disablement of nuclear facilities and suggested detailed stages for project.
September 27-30	At the second session of Sixth Round of Six-Party Talks held in Beijing, parties agree on second-phase actions for denuclearization (October 3 Agreement): -The North to disable and declare its nuclear facilities (second disablement investigation team to visit the North within two weeks) -U.S. government to determine when to terminate application of Trading with the Enemy Act and lift North's designation as state sponsor of terrorism in accordance with measures taken by the North -Economic and energy support equivalent to one million tons of heavy fuel oil on humanitarian grounds -Reconfirmation of Six-Party Ministerial Talks at opportune time in Beijing



Chronology	Major Developments
October 11-18	Delegation of U.S. experts visits North and adopted agreement on measures of nuclear disablement with the North: -11 items of disablement for three nuclear facilities in Yongbyon to be supervised by U.S. and completed within a year -Safekeeping and supervision of relevant sealed devices and materials separated or removed in mutually acceptable areas in the North
October 29-30	Third working-group meeting on Economic and Energy Cooperation convenes in Panmunjom. -Supply of 500,000 tons of heavy fuel oil and the relevant facilities and materials -Set standard heavy fuel oil price at USD400/ton and ancillary expenses at USD21/ton
November 1-15	First Team to Oversee North Korea Nuclear Disablement visits the North. -Simultaneous disablement measures taken for a total of 11 items of 3 nuclear facilities
November 10-13	First tripartite (ROK, North Korea, and China) meeting convenes in Shenyang, China. -Discussions about how to supply facilities and materials for shipments equivalent to 500,000 tons of heavy fuel oil
November 27-29	Disablement Observer team composed of South Korean, Russian, Chinese and Japanese members visits the North. -Monitors the site where disablement of three Yongbyon nuclear facilities was being implemented
2007 December 3-5	U.S. Assistant Secretary of State Christopher Hill delivers President George Bush's personal letter to the North. -Conveys U.S. position on status of nuclear facility disablement and report on North's nuclear program
December 11-12	Fourth working-group meeting on Economic and Energy Cooperation convenes in Beijing. -Discussions of formalizing HFO and non-HFO supply to the North
December 25-27	Second tripartite (ROK, North Korea, and China) meeting convenes in Pyongyang. -Three-party agreement on supply of the second portion of the facilities and materials to the North
2008 January 4	North Korean Foreign Ministry issues statement concerning its nuclear program. -Makes a declaration of nuclear programs and stresses that it informed the U.S. in November 2007 -Denies allegations about its uranium enrichment and nuclear program-related cooperation with Syria
January 7-12	Christopher Hill visits countries participating in Six-Party Talks, i.e., ROK, Russia, China and Japan. -Stresses the need for concerted efforts of relevant countries as well as complete and accurate reporting from the North
January 31- February 1	Sung Kim, head of U.S. State Department's Korea Desk, visits the North. -Coordinates content of North's declaration of its nuclear program and discussions about holding meeting involving senior Six-Party Talks representatives -Urges the North to early implement the October 3 Agreement
February 18-21	Christopher Hill visits the ROK, China and Japan. -Provides video evidence concerning nuclear-related collusion between North and Syria to ROK and China
February 21-22	Third tripartite (ROK, North Korea, and China) meeting (Beijing) -Discussed supply of the third portion of the facilities and materials to the North and assessment of current situation
March 13	U.S.-North Korea Talks convenes in Geneva. -U.S. suggests the North acknowledge its possession of highly enriched uranium indirectly by having secret agreement attached as separate document. -North delegation rejects U.S. suggestion, stressing that it is following instructions from Pyongyang.
March 24	U.S.-North working-level meeting convenes in New York. -The North offers a proposal for declaration of its nuclear program to the U.S..
March 27-28	Bilateral meeting between the two Koreas convenes at Panmunjom on ROK's economic aid to the North. -Exchanges opinions on how to supply the third portion of the facilities and materials and overall support to be provided at the Six-Party level

Chronology	Major Developments
April 8	<p>U.S.-DPRK meeting convenes in Singapore.</p> <ul style="list-style-type: none"> <li>-Acknowledge nuclear collusion between North and Syria, past UEP-related acts and inclusion of pledge against recurrence of such events</li> <li>-U.S. accepts uncertainties in progress toward next phase, although North's declaration of its nuclear program is considered not complete and accurate.</li> <li>-The two sides reaches tentative agreement on formality of the North's declaration of its nuclear program.</li> </ul>
April 10	<p>Second phase of third tripartite (ROK, North Korea, and China) meeting convenes in Beijing.</p> <ul style="list-style-type: none"> <li>-Reaches tentative agreement on supply plan of the third portion of facilities and materials (ROK: 35,000 tons/ China: 15,000 tons)</li> </ul>
April 22-24	<p>Experts from the U.S. (five, including Sung Kim) and the North meet in Pyongyang .</p> <ul style="list-style-type: none"> <li>-Discusses draft of North's declaration of its nuclear program. U.S. asks for additional information pertaining to nuclear waste stockpile sites and isotope production lab</li> <li>-The two sides agree to destroy a nuclear cooling tower within a day or two, following the submit of declaration of its nuclear program, as a symbolic gesture concerning the disablement measure.</li> <li>-The two sides discuss the North's substantial declaration of its nuclear program and how to verify it.</li> </ul>
April 28	<p>Meeting between senior representatives of the ROK and U.S. convenes in Washington, D.C.</p> <ul style="list-style-type: none"> <li>- Stresses the need to control verification and monitoring within Six-Party Talks</li> <li>- Briefs on meeting between experts of the U.S. and North and discussions about how to push ahead with the matter</li> </ul>
May 8-10	<p>Five-member U.S. delegation (including Sung Kim) makes second visit to the North.</p> <ul style="list-style-type: none"> <li>-The North submits 314 volumes (18,822 pages in seven boxes) of supplementary data concerning its nuclear program report.</li> <li>-Concerning lifting of its status as a state sponsor of terrorism, the North expresses its intention to submit its nuclear program report to China.</li> <li>-Reconfirms the North's intention to destroy nuclear cooling tower within 24 hours, following North's submittal of its declaration of nuclear program and U.S. removal of North from its list of state sponsors of terrorism</li> <li>-Suggests final coordination of the declaration draft and review on its agenda the U.S.</li> </ul>
May 13	<p>Meeting between senior representatives of the ROK and China convenes in Beijing.</p> <ul style="list-style-type: none"> <li>-Confirms that positive progress has been made concerning the North's declaration of its nuclear program and discusses how to process the North's unspent fuel rods</li> <li>-Discusses how to make progress in the next session of the Six-Party Talks</li> </ul>
May 19	<p>Meeting among senior representatives of the ROK, U.S. and Japan convenes in Washington, D.C.</p> <ul style="list-style-type: none"> <li>- Assesses progress of the Six-Party Talks and discusses future directions of promotion</li> </ul>
May 27-28	<p>Meeting between senior representatives of the U.S. and the North convenes in Beijing.</p> <ul style="list-style-type: none"> <li>-Discusses holding group meeting among technology experts before the North submits declaration of its nuclear program</li> </ul>
May 27-31	<p>Christopher Hill visits China and Russia.</p> <ul style="list-style-type: none"> <li>-Discusses problems related to the North's declaration of its nuclear program and resumption of the Six-Party Talks</li> </ul>
June 10	<p>Meeting among five donor countries convenes in Seoul.</p> <ul style="list-style-type: none"> <li>-Preliminary discussions of working-group meeting on Economic and Energy Cooperation</li> </ul>
June 11	<p>Fifth working-group meeting on Economic and Energy cooperation convenes at Panmunjom, resulting in tentative consent on the Agreed Minutes.</p> <ul style="list-style-type: none"> <li>-Supply of remainder of heavy fuel oil to North by October 2008</li> <li>-Drawing up agreement for supply of remainder of planned facilities and materials by August 2008</li> <li>-Prioritizing supply of anthracite gas facilities to the North</li> </ul>

Chronology	Major Developments
June 11-12	Third working-group meeting for normalization of DPRK-Japan relations convenes in Beijing. -The North says it would cooperate for the reinvestigation of abducted Japanese citizens and hijackers of a civilian airline (JAL-351) in 1970. -Japan hints at partial lifting of sanctions against the North.
June 12	North Korean Foreign Ministry announces that discussions have been carried out successfully . -Sung Kim, head of the U.S. State Department's Korea Desk, arrived in ROK on June 9, moved overland to Pyongyang on following day, returned to ROK on June 11, and held press briefing on June 12.
June 20	Tripartite meeting among senior representatives of the ROK, U.S. and Japan from Six-Party Talks (Tokyo)
June 26	The North submits declaration of its nuclear program to China. -U.S. President George Bush submits to Congress a report on changing the North's status as state sponsor of terrorism (measure to take effect on August 11, i.e., 45 days later).
June 27	The North destroys cooling tower for 5MWe nuclear reactor in Yongbyon and the U.S. cancels application of Trading with the Enemy Act against the North. -Sung Kim visits the North on June 27 and 28 and watches cooling tower being destroyed.
June 30	Number of spent fuel rods daily taken out increases from 15 to 30
July 10-12	Second meeting among the Sixth Round of Six-Party Talks' senior representatives and third working-group meeting for Korean Peninsula denuclearization convene in Beijing. -Assess the North's declaration of its nuclear program; establish a verification system; discuss closure of second phase of denuclearization and commencement of third phase -Establish a denuclearization-related verification system, complete disablement and provision of economic aid to the North by end of October -Denuclearization working-group meeting fails to agree on how to draw up verification protocol.
July 23	Unofficial Six-Party Foreign Ministers' meeting convenes in Singapore. -Participating countries consent to an six-item agreement on the second phase of the North's denuclearization process.
July 30-August 1	Sung Kim visits China, discusses how to verify the North's declaration of its nuclear program and meets with the North's representatives.
July 31-August 1	Sung Kim and Lee Geun, foreign ministry official from the North, meet twice in Beijing. -The North fails to explicitly say that it would allow sampling at its facilities. -The North re-stresses that IAEA should not take high-profile role.
August 11-12	Fourth working-group meeting on Normalization of DPRK-Japan Relations convenes in Shenyang, China. -Discusses reinvestigation on abduction of Japanese citizens, early lifting of sanctions on the North, early handover of hijackers of JAL 351 (1970 incident), and settlement of historical issues * Reaches agreement on second day of discussion, brightening prospects for ensuing sessions
August 14	North Korean Embassy in Beijing informs Chinese Foreign Ministry that it would stop taking out spent fuel rods.
August 14-16	Sung Kim visits China for discussions about how best to verify the North's declaration of its nuclear program. * Representatives of the North are absent from these discussions.
August 17	The U.S. delivers 6,000 tons of heavy fuel oil to Songrim, North Korea. Remaining balance of 10,000 tons would be delivered to Sonbong
August 22	Bilateral meeting between the U.S. and North convenes in New York. -The U.S. presents proposal for execution of complete and accurate nuclear verification to the North and asks for prompt reply. * Representatives unnamed but most likely Sung Kim (U.S. Special Envoy to Six-Party Talks) and Kim Myong-gil (Political Minister at North's UN Delegation)

Chronology	Major Developments
August 26	North Korean Foreign Ministry announces that North stopped disabling its nuclear facilities in Yongbyon on August 14 and that it is considering restoring the facilities.
September 2	The North begins restoring its nuclear facilities.
September 5-6	Meeting of Six-Party Talks senior representatives of the ROK, U.S., China and Japan convenes in Beijing. -Exchanges opinions on drawing up verification implementation plan -Discusses on how to deal with the North's threat to cease disablement process and restore its nuclear facilities
September 19	North Korean Foreign Ministry announces that the North has restored its nuclear facilities in Yongbyon. -Inter-Korean working-level meeting on Economic and Energy Cooperation to North convenes at Panmunjom. -Hwang Jun-guk (head of NK Nuclear Planning Group at Ministry of Foreign Affairs and Trade (MOFAT)) represents the South, and his counterpart is Hyon Hak-bong (Deputy Director General in charge of the U.S. at the North's Foreign Ministry). -Meeting ends with no concrete agreement on South-provided aid.
September 21	Bilateral meeting of Six-Party Talks' senior representatives from the ROK and U.S. -Agrees to work together to prevent deterioration of situation related to the North's nuclear program and discusses how to conclude the second phase of the disablement process
September 22	Phone conversation between U.S. President George Bush and Chinese President Hu Jintao -Agree to try and persuade the North to comply with what has been decided at Six-Party Talks IAEA Director General says that the North has asked IAEA personnel to remove surveillance cameras and seals from its nuclear facilities. -IAEA inspectors confirm that the North has restored some of its nuclear equipment to its original condition.
September 23	U.S. President George Bush gives a speech at UN General Assembly. -Saying that UN member countries should adopt firm attitude concerning reinforcement of sanctions against North Korea and Iran
September 24	IAEA inspectors remove seals and surveillance equipment from Yongbyon nuclear reprocessing facilities as per the North's request. The North announces plan to reintroduce nuclear materials into its facilities.
October 1-3	Christopher Hill visits North and discusses the North's nuclear program with Foreign Minister Park Ui-chun, Vice Foreign Minister Kim Gye-gwan, and Lt. General Lee Chan-bok. -First, method for Yongbyon nuclear facility-related verification is submitted and, then, proposal to separate issues concerning North's UEP and its collusion with Syria is made.
October 11	U.S. State Department removes North from its list of state sponsors of terrorism.
October 12	North Korean Foreign Ministry welcomes measure taken by the U.S. State Department. -Announces resumption of disablement process (October 14) and allows U.S. and IAEA monitors to carry out their duties in the North
October 25	The North's Korean Central News Agency reports that Japan should be deprived of its status as a member of the Six-Party Talks.
October 28	Meeting between Six-Party Talks senior representatives of the U.S. and Japan convenes in New York for discussions about the North's nuclear program.
October 31	Steps are taken to decrease the number of spent fuel rods from 30 to 15 a day.
November 6	Director General of North Korean Foreign Ministry visits New York for discussions on verification protocol with the U.S. -Reconfirms what has been verbally understood concerning verification-related core points

Chronology	Major Developments
November 12	North Korean Foreign Ministry announces that it denies verification-related agreement with the U.S.
November 24	Sung Kim meets Hwang Jun-guk (head of NK Nuclear Planning Group at South's MOFAT). -Discusses Six-Party Talks' senior representatives meeting
November 27	U.S. provides 50,000 tons of heavy fuel oil, bringing the accumulated total to 546,000 tons (broken down to 400,000 tons, plus relevant facilities equivalent of 146,000 tons).
December 3	Tripartite pre-consultation among the ROK, U.S. and Japan prior to the Six-Party Talks is held in Tokyo. -Agrees to include sampling in verification process
December 8-11	Meeting of Six-Party Talks senior representatives convenes in Beijing. -Discusses documentation related to verification, including sampling, and timetable for economic and energy assistance -Reaches no agreement concerning U.S. request for the North's entry into Treaty on the Non-Proliferation of Nuclear Weapons (NPT)
2009 January 15-19	ROK fact-finding team visits the North in regard to processing of unspent fuel rods. -Team is comprised of six people, i.e., head of MOFAT's NK Nuclear Planning Group and five others from the Ministry of Unification, Korea Atomic Energy Research Institute, and Korea Hydro & Nuclear Power Co., Ltd. -14,800 unspent fuel rods are worth about USD11 million-14 million. -Price offered by the North is about USD71 million.
February 2	The North's General Staff Department issues a statement on "Korean Peninsula denuclearization": 1. Korean Peninsula denuclearization should cover the entire Korean Peninsula rather than only the North. Denuclearization of the North would never occur unless the U.S. completely withdraws nuclear weapons from the South. 2. Korean Peninsula denuclearization should be realized through peninsula-wide verification. 3. Under current hostile relations between the two Koreas, the only possible way to remove nuclear weapons from the peninsula is for the nuclear powers to realize nuclear disarmament.
February 19-20	Third working-group meeting on Northeast Asia Peace and Security Mechanism convenes in Moscow. -Second round of discussions about basic principles concerning peace and security in region -Participants: Huh Chul (head of Peaceful Diplomacy Planning Group at MOFAT) and five others from ministries concerned -U.S. Secretary of State Hillary Clinton visits ROK.
March 7-10	U.S. special envoy to North Korea, Stephen Bosworth, visits South Korea.
March 12	Meeting between senior representatives of the ROK and Russia convenes.
March 16	Meeting between senior representatives of the ROK and Japan convenes.
March 26	North Korean Foreign Ministry issues statement: -The world would not see the North at Six-Party Talks and the North would restore its nuclear facilities if UN Security Council issues presidential statement on its launch of a satellite or a country submits any North-related agenda to UN Security Council.
March 27	Tripartite (ROK, U.S. and Japan) meeting convenes.
April 5	The North launches a long-range rocket (at 11: 30: 15 AM).
April 14	UN Security Council unanimously adopts presidential statement against the North, concerning its launch of a long-range rocket. North Korean Foreign Ministry issues statement rejecting the Six-Party Talks and publicizing its intention to reinforce its nuclear deterrence. North orders IAEA personnel at the Yongbyon nuclear facilities to leave the country.

Chronology	Major Developments
April 16	IAEA monitoring team (2) is expelled from the North.
April 17	Four U.S. members of monitoring team are expelled from the North.
April 24	UN Security Council Sanctions Committee selects and imposes sanctions on businesses in the North: Tanchon Commercial Bank, Korea Mining Development Trading Corporation, and Korea Ryongbong General Corporation.
April 25	The North announces that it starts reprocessing spent fuel rods from pilot nuclear power plant.
April 29	North Korean Foreign Ministry announces the country's decision to construct light water reactor and carries out technological testing for production of nuclear fuel.
May 25	The North carries out its second nuclear test.
May 25-29	The North test-fires short-range missiles: -Two surface-to-ship missiles on May 25; a surface-to-ship missile and a surface-to-air missile on May 26; and a surface-to-air missile on May 29
June 12	UN Security Council adopts Resolution 1874: -Expressing gravest concern at North's nuclear test and at the challenges such a test constitutes to the Treaty on the Non-Proliferation of Nuclear Weapons (NPT) and to international efforts aimed at strengthening the global non-proliferation regime -Referring to Article 41, Chapter VII, United Nations Charter ("The Security Council may decide what measures not involving the use of armed force are to be employed to give effect to its decisions.")
June 13	North Korean Foreign Ministry issues a statement: -It flatly rejects the UN resolution. -It would start uranium enrichment and weaponize all newly extracted plutonium. -It would consider any blockade attempt as an act of war to be met with a decisive military response.
July 2	The North test-fires four surface-to-ship missiles from Sinsang-ri, Hambuk Province .
July 4	The North test-fires five Scud missiles and two Rodong missiles from Kittaeryong, Kangwon Province.
July 27	ROK government submits its implementation plan concerning UN Security Council Resolution 1874: -Control of weapons and strategic commodities trade with the North, a ban on transfer of technology, training and advice to the North -Effectuation of governmental sanction, including cargo searches, financial/economic sanctions and additional future measures under relevant law -Sanctions against the following five businesses, five individuals, and two (additional) commodities: -Businesses: Namchongang Trading, General Bureau of Atomic Energy, Hong Kong Electronics, Korea Hyoksin Trading Corporation, and Korea Tangun Trading Corp -Individuals: Yun Ho-jin (Namchongang Trading), Ri Je-son (Director of General Bureau of Atomic Energy), Hwang Sok-hwa (General Bureau of Atomic Energy), Ri Hong-Sop (former head of Yongbyon Nuclear Research Center), and Han Yu-ro (Korea Yongaksan Trading Company)
September 4	Head of North Korean delegation to UN sends a letter to President of UN Security Council saying that his country is in the final stage of reprocessing spent fuel rods and successfully carries out enrichment of uranium.
November 3	North's Korean Central News Agency (KCNA) announces that the country completed reprocessing spent fuel rods.
2010 January 11	North Korean Foreign Ministry issues a statement proposing a meeting for peace treaty between signatories of Armistice Agreement. -For first time since it announced withdrawal from the Six-Party Talks in April 2009, it comments on a possible return to the Six-Party Talks in connection with lifting the international community's sanctions.

Chronology	Major Developments
March 29	KCNA says that the country's reply to the international community would be a light-water reactor power plant operating on self-generated nuclear fuel in the 2010s.
May 12	Rodong Sinmun reports that the country succeeds in nuclear fusion with its own technology.
May 24	North Korean Foreign Ministry announces that the country has the right to continue to expand and reinforce its nuclear deterrence.
June 15	U.S. President Barack Obama announces extension of economic sanctions against the North for another year to June 26, 2011.
June 28	North Korean Foreign Ministry announces that the country strengthens its nuclear deterrence to that of a more advanced state.
July 9	UN Security Council unanimously adopts a presidential statement on the Cheonan Incident.
July 26	Minister of the People's Armed Forces, Kim Yong Chun, says, "We will reinforce our nuclear deterrence even further in response to the aggravating nuclear threat from the U.S.," at a press conference for the 57 <sup>th</sup> anniversary of the signing of the Armistice Agreement.
August 2	Robert J. Einhorn, U.S. Coordinator for Iran and North Korea Sanctions, says that the U.S. would impose additional sanctions against more businesses and individuals involved in the North's activities related to WMDs and missiles.
August 8	Rodong Sinmun reports that the country would bolster its nuclear deterrence even further to face enemies on equal footing.
September 30	The North's UN Ambassador says that his country would never give up its nuclear deterrence.
October 8	Institute for Science and International Security in the U.S. says that the North's highly enriched uranium ( HEU) development program has gone beyond lab level.
November 17	President Charles Jack Pritchard of the Korea Economic Institute (KEI) in the U.S. says, "North Korea is building a 100MW experimental light water reactor in Yongbyon slated for completion by 2012."
November 21	Siegfried Hecker, Co-Director of the Center for International Security and Cooperation, Stanford University, reports seeing hundreds of centrifuges installed at Yongbyon nuclear facility during his visit from November 9 to 13.

# History of North Korea's Missile Development Program and Specifications

## Chronology

Early 1970s	North Korea obtains missile technology, (possibly) from participation in the People's Republic of China's missile development program
1976-1981	Initiates development efforts working from an imported Soviet-made SCUD-B missile and an Egyptian launch pad
April 1984	First SCUD-B missile test-firing
May 1986	SCUD-C missile test-firing
1988	Operational deployment of SCUD-B/C missiles
May 1990	First Rodong missiles test-firing
June 1991	SCUD-C missiles firing
May 1993	Rodong missiles test-firing
January 1994	First identification of a Daepodong-1 missile
1998	Operational deployment of Rodong missiles
August 1998	Daepodong-1 missile test-firing (North insists it was a satellite.)
July 2006	Daepodong-2, Rodong and SCUD missiles test-firing
2007	Operational deployment of Musudan missiles (IRBMs)
April 2009	Firing of a long-range rocket (improved version of the Daepodong-2) (North insists it was a satellite.)
July 2009	Rodong and SCUD missiles firing

## Specifications

	SCUD-B	SCUD-C	Rodong	Musudan (IRBM)	Daepodong-1	Daepodong-2
Range (km)	300	500	1,300	Over 3,000	2,500	Over 6,700
Warhead weight (kg)	1,000	700	700	650	500	650-1,000 (est.)
Remarks	Operational deployment	Operational deployment	Operational deployment	Operational deployment	Test-firing	Under development



## Chronology of South-North Military Talks

No.	Classification	Date	Place	Details of Major Consultations/Agreements
1	1 <sup>st</sup> Round of the Inter-Korean Defense Ministerial Talks	September 24 - 26, 2000	Jeju Island	<ul style="list-style-type: none"> <li>• Adoption of the five-point joint press release of the inter-Korean Defense Ministerial Talks</li> </ul>
2	1 <sup>st</sup> Round of the inter-Korean Military Working-level Talks	November 28, 2000	Panmunjom Unification Pavilion	<ul style="list-style-type: none"> <li>• Major details of the discussion: (proposed) Inter-Korean Agreement on Military Assurances               <ul style="list-style-type: none"> <li>-Designation of the timing and scope of the Joint Administrative Area (JAA), location of the roads, and construction of facilities in the JAA</li> <li>-Security assurance issue for DMZ construction works</li> <li>-Simultaneous commencement of landmine removal in the DMZ</li> </ul> </li> </ul>
3	2 <sup>nd</sup> Round of the Inter-Korean Military Working-level Talks	December 5, 2000	Panmunjom House of Peace	<ul style="list-style-type: none"> <li>• Major details of the discussion: (proposed) Inter-Korean Agreement on Military Assurances               <ul style="list-style-type: none"> <li>-Finalization of the routes of the inter-Korean roads</li> <li>-Discussion of the designation and operation of the JAA as well as joint regulations</li> <li>-Agreement of signature/entry into force of the agreements regarding safety issues during construction in the ministerial talks</li> <li>-Narrowing the differences regarding the simultaneous commencement of landmine removal in the DMZ</li> </ul> </li> </ul>
4	3 <sup>rd</sup> Round of the Inter-Korean Military Working-level Talks	December 21, 2000	Panmunjom Unification Pavilion	<ul style="list-style-type: none"> <li>• Centering around the South's response to the issue regarding the concept of main enemy posed by the North               <ul style="list-style-type: none"> <li>-The meeting ends after the South explains and delivers its proposed agreement to the North. The two sides decide to discuss the proposed agreement in ensuing talks.</li> </ul> </li> </ul>
5	4 <sup>th</sup> Round of the Inter-Korean Military Working-level Talks	January 31, 2001	Panmunjom House of Peace	<ul style="list-style-type: none"> <li>• Major details of the discussion: (proposed) Inter-Korean Agreement on Military Assurances               <ul style="list-style-type: none"> <li>-Designation and operation of the JAA</li> <li>-Mine removal in the DMZ, method of road &amp; railway reconnection works, and the method of contact and communication between the military personnel in charge of the construction sites</li> <li>-Security on construction personnel &amp; equipment and safety assurance issues</li> </ul> </li> </ul>
6	5 <sup>th</sup> Round of the Inter-Korean Military Working-level Talks	February 8, 2001	Panmunjom Unification Pavilion	<ul style="list-style-type: none"> <li>• Agreement on Military Assurances for Designation of the Joint Administrative Area in the East/West Coast Districts and the Construction of Railways and Roads Connecting the South and North               <ul style="list-style-type: none"> <li>※Signature/entry into force is delayed due to the excuse of the concept of main enemy.</li> </ul> </li> </ul>

No.	Classification	Date	Place	Details of Major Consultations/Agreements
7	6 <sup>th</sup> the Inter-Korean Military Working-level Talks	September 14, 2002	Panmunjom House of Peace	<ul style="list-style-type: none"> <li>• Adoption of the Agreement on Military Assurances for Designation of the Joint Administrative Area in the East/ West Coast Districts and the Construction of Railways and Roads Connecting the South and North</li> <li>→ agrees to sign/exchange/come into force agreement through additional two rounds of talks [September 16/17]</li> </ul>
8	7 <sup>th</sup> Round of the Inter-Korean Military Working-level Talks	September 16, 2002	Panmunjom Unification Pavilion	<ul style="list-style-type: none"> <li>• Confirmation and initial exchange of the text of the Military Assurance Agreement, and discussion of the procedures of the 7<sup>th</sup> Inter-Korean Military Working-level Talks</li> </ul>
9	8 <sup>th</sup> Round of the Inter-Korean Military Working-level Talks	September 17, 2002	Panmunjom House of Peace	<ul style="list-style-type: none"> <li>• Exchange and effectuation of the Agreement on Military Assurances for Designation of the Joint Administrative Area in the East/West Coast Districts and the Construction of Railways and Roads Connecting the South and North</li> </ul>
10	9 <sup>th</sup> Round of the Inter-Korean Military Working-level Talks	October 3, 2002	Panmunjom Unification Pavilion	<ul style="list-style-type: none"> <li>• Exchange and discussion of the mutual construction plans by timeline and route diagrams for the reconnection of railways and roads</li> <li>• Negotiation on the support of communication equipment</li> </ul>
11	10 <sup>th</sup> Round of the Inter-Korean Military Working-level Talks	October 11, 2002	Panmunjom House of Peace	<ul style="list-style-type: none"> <li>• Balancing construction works for inter-Korean railway &amp; road reconnection and providing equipment for demining in DMZ</li> </ul>
12	11 <sup>th</sup> Round of the Inter-Korean Military Working-level Talks	October 16, 2002	Panmunjom Unification Pavilion	<ul style="list-style-type: none"> <li>• Consultation over the balanced construction works for inter-Korean railway &amp; road reconnection in DMZ</li> </ul>
13	12 <sup>th</sup> Round of the Inter-Korean Military Working-level Talks	October 25, 2002	Panmunjom House of Peace	<ul style="list-style-type: none"> <li>• Discussion of matters regarding verification of balanced construction of road &amp; railway construction, joint survey and communication line connection for the Donghae Line</li> </ul>
14	13 <sup>th</sup> Round of the Inter-Korean Military Working-level Talks	November 13, 2002	Panmunjom Unification Pavilion	<ul style="list-style-type: none"> <li>• Discussion of matters regarding verification of balanced construction of road &amp; railway construction, joint survey and communication line connection for the Donghae Line</li> </ul>
15	14 <sup>th</sup> Round of the Inter-Korean Military Working-level Talks	December 23, 2002	Panmunjom House of Peace	<ul style="list-style-type: none"> <li>• Consultations over the (proposed) makeshift road passage agreement regarding the Gyeongui Line and Donghae Line, and connection of the communication lines concerning the Donghae Line</li> </ul>
16	15 <sup>th</sup> Round of the Inter-Korean Military Working-level Talks	January 27, 2003	Panmunjom Unification Pavilion	<ul style="list-style-type: none"> <li>• Adoption and effectuation of the Provisional Agreement on Military Assurances for Passage of Makeshift Roads in the Joint Administrative Area in the East and West Corridors</li> </ul>

No.	Classification	Date	Place	Details of Major Consultations/Agreements
17	16 <sup>th</sup> Round of the Inter-Korean Military Working-level Talks	June 4, 2003	Panmunjom Unification Pavilion	<ul style="list-style-type: none"> <li>• Agreement on mutual visits to the temporal road construction sites for inspections (Number of personnel: 10 persons each for the east and west coast districts on June 11)</li> </ul>
18	17 <sup>th</sup> Round of the Inter-Korean Military Working-level Talks	September 17, 2003	Panmunjom Unification Pavilion	<ul style="list-style-type: none"> <li>• Adoption and effectuation of the Supplementary Agreement on the Provisional Agreement on Military Assurances for Passage of Makeshift Roads in the Joint Administrative Area in the East and West Coast Districts</li> </ul>
19	18 <sup>th</sup> Round of the Inter-Korean Military Working-level Talks	November 14, 2003	Panmunjom, House of Peace	<ul style="list-style-type: none"> <li>• Expression of mutual positions on the proposed Agreement on Installation and Operation of Guard Posts in the Joint Administrative Area</li> <li>• Consultation of date for the contact between persons in charge of communication in relation to connection of communication lines of Donghae line</li> </ul>
20	19 <sup>th</sup> Round of the Inter-Korean Military Working-level Talks	November 28, 2003	Panmunjom, Unification Pavilion	<ul style="list-style-type: none"> <li>• Consultation over Agreement on Installation and Operation of Guard Posts</li> </ul>
21	20 <sup>th</sup> Round of the Inter-Korean Military Working-level Talks	December 23, 2003	Panmunjom House of Peace	<ul style="list-style-type: none"> <li>• Exchange and effectuation of the Agreement on and Installation Operation of Guard Posts in the Joint Administrative Area in the East and West Coast Districts</li> </ul>
22	1 <sup>st</sup> Round of the Inter-Korean General Officer-level Talks	May 26, 2004	Mt. Kumgang, North Korea	<ul style="list-style-type: none"> <li>• Expression of mutual positions regarding measures to prevent accidental Naval clashes in the West Sea and to stop propagand activities and remove propagand apparatus from the DMZ</li> </ul>
23	2 <sup>nd</sup> Round of the Inter-Korean General Officer-level Talks	June 3-4, 2004	Mt. Seorak, South Korea	<ul style="list-style-type: none"> <li>• Adoption and effectuation of the Agreement on the Prevention of Accidental Naval Clashes in the West Sea, Elimination of Propaganda Apparatus from the DMZ</li> </ul>
24	21 <sup>st</sup> Round of the Inter-Korean Military Working-level Talks	June 10-12, 2004	Kaesong, North Korea	<ul style="list-style-type: none"> <li>• Adoption and effectuation of the Subsequent Agreement on the Agreement on the Prevention of Accidental Naval clashes in the West Sea, and the Cessation of Propaganda Activities and the Elimination of Propaganda Apparatus from the DMZ</li> </ul>
25	22 <sup>nd</sup> Round of the Inter-Korean Military Working-level Talks	June 29-30, 2004	Paju, South Korea	<ul style="list-style-type: none"> <li>• Assessment regarding prevention of accidental naval clashes in the West Sea and first-stage propagand apparatus removal</li> </ul>
26	23 <sup>rd</sup> Round of the Inter-Korean Military Working-level Talks	July 5, 2004	Kaesong, North Korea	<ul style="list-style-type: none"> <li>• Consultation over differences regarding the subjects of first-stage propagand apparatus removal, agreement to implement second-stage works. ROK suggests improvement measures to prevent accidental clashes in the West Sea.</li> </ul>

No.	Classification	Date	Place	Details of Major Consultations/Agreements
27	24 <sup>th</sup> Round of the Inter-Korean Military Working-level Talks	July 20, 2005	Panmunjom House of Peace	<ul style="list-style-type: none"> <li>• Consultation over differences regarding the subjects of first-stage propaganda apparatus removal</li> <li>• Consultation over initiating third-stage propaganda apparatus removal (July 25-August 13)</li> <li>• Agreement to setting up the communication liaison office to prevent accidental naval clashes in the West Sea (since August 13)</li> <li>• Suggestion of the Supplementary Agreement Pertaining to Improvement Measures to Prevent Accidental Clashes in the West Sea</li> </ul>
28	25 <sup>th</sup> Round of the Inter-Korean Military Working-level Talks	August 12, 2005	Panmunjom Unification Pavilion	<ul style="list-style-type: none"> <li>• Consultation over differences regarding the subjects of third-stage propaganda apparatus removal</li> </ul>
29	26 <sup>th</sup> Round of the Inter-Korean Military Working-level Talks	November 3, 2005	Panmunjom House of Peace	<ul style="list-style-type: none"> <li>• Agreement to discuss the Agenda for General Officer-level Talks and the Military Assurances Agreement on Railway/Road Passage</li> </ul>
30	27 <sup>th</sup> Round of the Inter-Korean Military Working-level Talks	February 3, 2006	Panmunjom Unification Pavilion	<ul style="list-style-type: none"> <li>• Agreement to convene the third round of the General Officer-level Talks</li> <li>• Agreement to discuss the Military Assurance Agreement on Railway/Road Passage</li> </ul>
31	3 <sup>rd</sup> Round of the Inter-Korean General Officer-level Talks	March 2-3, 2006	Panmunjom Unification Pavilion	<ul style="list-style-type: none"> <li>• ROK, to make proposals on prevention of accidental clashes in the West Sea and establishment of Joint fishing area, and conclusion of the Military Assurance Agreement on Railway/Road Passage</li> <li>• North Korea, to bring up issues on re-establishing the West Sea Maritime Borderline</li> </ul>
32	4 <sup>th</sup> Round of the Inter-Korean General Officer-level Talks	May 16-18, 2006	Panmunjom House of Peace	<ul style="list-style-type: none"> <li>• ROK, expression of the intention to discuss in the Inter-Korean Defense Ministerial Talks on the basis of following two principles as regards Maritime Borderline in the West Sea <ul style="list-style-type: none"> <li>① Respect/observe NLL as agreed in the Basic-Agreement</li> <li>② Comprehensive implementation as for agreed items of military area in the Basic Agreement</li> </ul> </li> <li>• North Korea, to deny insisting that re-establishing West Sea Maritime Borderline is the basic problem that must be resolved first</li> </ul>
33	28 <sup>th</sup> Round of the Inter-Korean Military Working-level Talks	October 2, 2006	Panmunjom Unification Pavilion	<ul style="list-style-type: none"> <li>• North Korea, to protest against scattering leaflets and violation of East/West area transportation order</li> <li>• ROK, to raise military assurance measures for economic cooperation project and expansion of confidence-building</li> </ul>

No.	Classification	Date	Place	Details of Major Consultations/Agreements
34	5 <sup>th</sup> Round of the Inter-Korean General Officer-level Talks	May 8-11, 2007	Panmunjom Unification Pavilion	<ul style="list-style-type: none"> <li>• Joint press release for the General Officer-level Talks</li> <li>• Adoption of the Provisional Agreement on Military Assurances of Railroad Test Runs</li> </ul>
35	29 <sup>th</sup> Round of the Inter-Korean Military Working-level Talks	June 8, 2007	Panmunjom House of Peace	<ul style="list-style-type: none"> <li>• Discussion about implementation of agreements from the joint press release of the fifth round of the General Officer-level Talks</li> </ul>
36	30 <sup>th</sup> Round of the Inter-Korean Military Working-level Talks	July 10, 2007	Panmunjom Unification Pavilion	<ul style="list-style-type: none"> <li>• Discussion about implementation of agreements from the joint press release of the fifth round of the General Officer-level Talks</li> </ul>
37	31 <sup>st</sup> Round of the Inter-Korean Military Working-level Talks	July 16, 2007	Panmunjom House of Peace	<ul style="list-style-type: none"> <li>• Discussion about draft for the Agreements to be addressed in the 6<sup>th</sup> round of the General Officer-level Talks</li> </ul>
38	6 <sup>th</sup> Round of the Inter-Korean General Officer-level Talks	July 24-26, 2007	Panmunjom House of Peace	<ul style="list-style-type: none"> <li>• Discussed prevention of west sea clashes, establishment of joint fishing area, and military assurances to inter-Korean economic cooperation but ended with no progress</li> </ul>
39	32 <sup>nd</sup> Round of the Inter-Korean Military Working-level Talks	November 12, 2007	Panmunjom Unification Pavilion	<ul style="list-style-type: none"> <li>• Discussion about working-level issues on the second round of inter-Korean Defense Ministerial Talks</li> </ul>
40	33 <sup>rd</sup> Round of the Inter-Korean Military Working-level Talks	November 20, 2007	Panmunjom House of Peace	<ul style="list-style-type: none"> <li>• Discussed working-level procedures yet to be agreed and fine-tuned drafts for agreements for the second round of the Defense Ministerial Talks</li> </ul>
41	34 <sup>th</sup> Round of the Inter-Korean Military Working-level Talks	November 24, 2007	Panmunjom House of Peace	<ul style="list-style-type: none"> <li>• Fine-tuned drafts for agreements for the second round of the Defense Ministerial Talks</li> </ul>
42	2 <sup>nd</sup> Round of Inter-Korean Defense Ministerial Talks	November 27-29, 2007	Pyongyang Songjeon Pavilion	<ul style="list-style-type: none"> <li>• Adoption of the Agreements from inter-Korean Defense Ministerial Talks to implement the Declaration for inter-Korean Development and Peaceful Prosperity, consisting of seven Sections and 21 Paragraphs</li> </ul>
43	35 <sup>th</sup> Round of the Inter-Korean Military Working-level Talks	December 5, 2007	Panmunjom Unification Pavilion	<ul style="list-style-type: none"> <li>• Military Assurance Agreement on Railway Freight Transport between Munsan and Bongdong</li> </ul>

No.	Classification	Date	Place	Details of Major Consultations/Agreements
44	7 <sup>th</sup> Round of the Inter-Korean General Officer-level Talks	December 12-14, 2007	Panmunjom House of Peace	<ul style="list-style-type: none"> <li>• Adopts the Agreements on Military Assurances for 3Cs for Joint Administrative Area in East/West Area, but it failed to be implemented               <ol style="list-style-type: none"> <li>1. Extending passage time (07:00-22:00) and guaranteeing passage everyday</li> <li>2. Allowing wire/wireless communication and internet communication from 2008</li> <li>3. Simplifying procedures to shorten passage time, etc</li> </ol> </li> <li>• Discusses the establishment of joint fishing area and peace zone but it ended with no progress due to contentions on location of joint fishing areas</li> </ul>
45	36 <sup>th</sup> Round of the Inter-Korean Military Working-level Talks	January 25, 2008	Panmunjom House of Peace	<ul style="list-style-type: none"> <li>• Discussion about railroad cargo transportation between Munsan and Bongdong</li> </ul>
46	37 <sup>th</sup> Round of the Inter-Korean Military Working-level Talks	October 2, 2008	Panmunjom House of Peace	<ul style="list-style-type: none"> <li>• Discussion about implementation issues between the two militaries</li> <li>※ North Korea persistently focuses on the South's civilian organizations' flying leaflets to the North</li> </ul>
47	38 <sup>th</sup> Round of the Inter-Korean Military Working-level Talks	September 30, 2010	Panmunjom House of Peace	<ul style="list-style-type: none"> <li>• ROK urges North Korea to take responsible measures for the sinking of ROKS Cheonan, to cease military threats and provocation against ROK territorial waters, to put an end to the slandering against ROK authorities</li> <li>• North Korea refuses the findings on the sinking of ROKS Cheonan by the ROK side and reiterates its assertion of dispatching an inspection group while making the issue of the leaflet flying by civilian groups and intrusion of ROK Navy vessels into territorial water claimed by the North</li> </ul>

## Chronicle of Inter-Korean Relations

The North	Date	The South
	2008 February 25	The Lee Myung-bak administration inaugurates
Telefax message to the South: "North ceases all contact and dialogue with South, and bans South Korean officials crossing MDL."	March 29	
Rodong Sinmun, the North's official newspaper, starts virulently condemning the ROK government, even attacking the South's new president by name.	April 1	
	April 2	Telefax message to the North: "South regrets North's recent stance and urges the North to refrain from behavior that will cause tension on the Korean Peninsula."
	July 11	North Korean guard shoots and kills South Korean tourist at Mt. Kumgang resort.
Spokesperson for North's Bureau for Guiding the General Development of Tourist Resorts: "It is regrettable that the South has stopped the Mt. Kumgang tourism program. An apology from the South is called for as are measures in case of similar occurrences."	July 12	Telefax message to the North: "South will temporarily halt tourism to Mt. Kumgang." * North refuses to acknowledge message.
	July 13	Spokesperson for the South's Ministry of Unification: "South urges the North to accept its fact-finding team to investigate fatal shooting of a South Korean tourist; and to take measures to prevent recurrence of similar incidents."
	July 15	Telefax message to the North: "South urges the North to accept dispatch of its fact-finding team South to the site of fatal shooting." * North refuses to acknowledge message.
Spokesperson for the North's military unit in charge of Mr. Kumgang region (special statement): "North will expel any unnecessary South Korean and strictly limit the number of South Koreans crossing the MDL."	August 3	Spokesperson for the Ministry of National Unification: "South regrets about unreasonable behavior of the North and urges acceptance of its fact-finding team to investigate."
Telefax message sends to the South: "North will expel South Koreans from Mt. Kumgang Tourism Region, effective August 10."	August 9	

The North	Date	The South
37 <sup>th</sup> South-North Military Working-Level Talks * North strongly objects to issue of South Korean civilian groups flying leaflets across border into North by balloons and other means.	October 2	37 <sup>th</sup> South-North Military Working-Level Talks * South urges North to stop slandering ROK President, fully resume dialogue, settle tourist shooting incident on Mt, Kumgang, and make access to Kaesong Industrial Complex more convenient for South Koreans.
Rodong Sinmun warns: "possibility of relinquishing all relations with South."	October 16	
Inter-Korean military working-level contact held *North objects to private South Korean groups sending leaflets into North and warns it could have adverse impact on Kaesong Industrial Complex and Kaesong tours.	October 27	Inter-Korean military working-level contact held *South urges North to resolve issues, like delays in granting South Koreans permits to travel in South-North Joint Administrative Area (JAA), and stop limiting work hours for South Korean commuters.
Spokesperson for North's delegation to Inter-Korean Military Talks warns: "Military action might be taken against flying of leaflets."	October 28	
North's military, Korean People's Army (KPA) inspection team checks status of Kaesong Industrial Complex.	November 6	
Telefax message to the South: "North will limit or stop South Koreans crossing the inter-Korean border (land crossing), effective December 1."	November 12	
	November 13	Telefax message to North: South expresses its position on continuing operation and development of Kaesong Industrial Complex, and proposes the discussion of materials and equipment supply for normalization of military communications line.
Telefax message to the South: "North will limit the crossing of South Koreans to and from the MDL, stop Kaesong tours and the operation of trains between the two Koreas, and close the Consultative Office for Inter-Korean Economic Cooperation, effective December 1."	November 24	
Bureau for Guiding the General Development of Tourist Resorts: "North will reduce the number of South Koreans in Mt. Kumgang District by half."	November 26	
Telefax message to the South: "North will reduce the daily hours for the land crossing of South Koreans through the MDL, effective December 1."	November 27	
North implements "December 1 Measure" * Limits crossing of South Koreans through MDL stops Kaesong tours, ceases the operation of the South-North railway, and restricts land crossing between the two Koreas	December 1	



The North	Date	The South
North releases New Year's Editorial: "2009 is the year to heighten the revolutionary spirit for the construction of a strong and prosperous nation."	2009 January 1	
	January 2	President Lee Myung-bak's New Year's Address stresses: "We will settle relations with the North in a resolute and flexible manner."
North's General Staff says: "North will assume all-out confrontational posture against South."	January 17	
North's Committee for the Peaceful Reunification of the Fatherland (CPRF) says: "All political and military agreements with the South are now invalid."	January 30	Ministry of Unification Spokesperson says: "The North's statement is regrettable. The South will take strong countermeasures if the Northern Limit Line is violated."
KPA says at a press conference: "North supports nuclear disarmament."	February 2	
North's Korean Aerospace Technology Committee announces: "North is preparing a satellite launch."	February 24	
North at General-Level Military Talks between UN Command (UNC) and KPA demands cancellation of KR/FE combined exercises.	March 2	General-Level Military Talks between UN Command (UNC) and KPA * UNC defends need for KR/FE combined exercises.
CPRF statement threatens: "North cannot guarantee safety of South Korean commercial airliners." North's General Staff statement threatens: "Inter-Korean military communications line may be severed."	March 5	2009 ROK-U.S. KR/FE combined exercises will be conducted until March 20.
UNC-KPA General Officer-Level Military Talks held * North defends launch of long-range rocket (Kwangmyongsong -2) as a right of sovereign state under international law.	March 6	UNC-KPA General Officer-Level Talks * UNC urges North to cease missile launches.
Korean Central News Agency (KCNA) announces: North has joined International Space Convention.	March 12	
North detains two U.S. female reporters.	March 17	
CPRF statement goes: "North will take resolute countermeasures if South takes part in Proliferation Security Initiative (PSI)." *North detains one South Korean employee working in Kaesong Industrial Complex.	March 30	
North's General Staff issues critical statement: "North has assumed a high-level combat posture."	April 2	ROK-U.S. Summit at G20 in the UK

The North	Date	The South
North launched improved version of long-range missile (Daepodong 2).	April 5	ROK government statement announces: "North's launch of a long-range missile is in clear violation of UN Security Council Resolution 1718. ROK expresses serious concern over North's such action. Concrete countermeasures would be taken in consultation with UN and countries concerned."
North's Foreign Ministry says: "North will withdraw from the Six-Party Talks and restore its nuclear facilities."	April 14	
General Bureau for Central Guidance to the Development of the Special Zone proposes "Inter-Korean meeting on April 21 (April 21 Meeting)."	April 16	
North's General Staff Spokesperson criticizes: "South's participation in Proliferation Security Initiative (PSI) will be regarded as a declaration of war."	April 18	
Both sides meet to discuss Kaesong Industrial Complex. * North announces it would reconsider matters concerning land lease agreement and it will adjust wages for North Korean workers.	April 21	Both sides meet to discuss Kaesong Industrial Complex. * South urges North to release South Korean detained at Kaesong Industrial Complex and proposes efforts for prompt settlement of issue related to 3Cs (Crossing, Communications and Customs Clearance).
KCNA reports: "South has taken provocative military action by relocating MDL markers."	April 22	South's Joint Chiefs of Staff denies KCNA report.
North's Foreign Ministry Spokesperson: "North has started reprocessing spent fuel rods."	April 25	
North's Foreign Ministry Spokesperson threatens: "North will resume nuclear testing and test-launch an ICBM."	April 29	
North carries out its second nuclear test and test-fires two short-range missiles.	May 25	ROK government statement condemns: "Such an act poses a serious threat to world peace, is a grave challenge to the international NPT system, and constitutes a clear violation of UN Security Council Resolution 1718." * South urges North to return to NPT regime.
North test-fires three short-range missiles	May 26	ROK government announces its full participation in PSI.
- North test-fires two short-range missiles North's delegation to Panmunjom threatens: "The South's participation in PSI is a declaration of war, and we will counter this with a military strike, reject the binding power of the Armistice Agreement, contest the legal status of the five West Sea islands and no longer guarantee the safety of South Korean ships traveling in our waters." CPRF statement threatens: "Any inspection on the North's ships by the South will face resolute and merciless wartime-like retaliation."	May 27	

The North	Date	The South
North's Foreign Ministry says: "The North's nuclear test is a self-defensive measure, and the UN Security Council should withdraw its resolution against the North."	May 29	
First Inter-Korean working-level talks concerning Kaesong Industrial Complex * North asks for land lease fee to be raised by USD 500 million and its workers' monthly wage to be raised by USD 300.	June 11	First inter-Korean working-level talks concerning Kaesong Industrial Complex * South indicates North's demands unrealistic
	June 12	UN Security Council adopts Resolution 1874 against North Korea.
North's Foreign Ministry statement goes: "The North is enriching uranium, will weaponize all plutonium produced and take military countermeasures in the event of a blockade against it."	June 13.	
	June 16.	ROK-U.S. Summit * ROK-U.S. Vision for Strategic Alliance adopts
Second Inter-Korean working-level talks concerning Kaesong Industrial Complex held * North reiterates previous demand.	June 19.	Second inter-Korean working-level talks concerning Kaesong Industrial Complex * South presents three principles (i.e., observance of agreements, economic principles, and future-orientedness) for development of Kaesong Industrial Complex. South also proposes joint inspection of foreign-invested industrial units in the Complex .
Third inter-Korean working-level talks concerning Kaesong Industrial Complex held * North requests USD 500 million in increased land lease fee as precondition to mitigation of restrictions on crossing of South Koreans across MDL. -North test-fires four short-range missiles.	July 2	Third inter-Korean working-level talks concerning Kaesong Industrial Complex * South urges North to immediately release South Korean employees detained at Kaesong Industrial Complex.
North test-fires Rodong missiles and SCUD missiles, a total of 7 missiles.	July 4	
	July 6	UN Security Council presidential statement criticizes North's test-firing.
Kim Yong-nam, Standing Committee Chairman of Supreme People's Assembly: "No more Six-Party Talks needed permanently." * Conference of Nonaligned Countries held in Cairo	July 16	UN Security Council finalizes list of those in North subject to sanctions under Resolution 1874: * Five businesses and institutions, five individuals, and two commodities
North's UN Ambassador Sin Son-ho says: "North will not oppose dialogue with the U.S."	July 25	
North's Foreign Ministry issues statement: The North proposes bilateral dialogue with the U.S.	July 27	

The North	Date	The South
	July 29	U.S. State Department Spokesperson says: "U.S. will enter into a dialogue with North Korea within the framework of the Six-Party Talks."
North seizes South Korean fishing vessel the Yeonan 800.	July 30	Telefax message to North from Ministry of Unification: "North should immediately repatriate the Yeonan 800."
Telefax message to South: "South Korean vessel being investigated and will be handled according to results of investigation."	July 31	Telefax message to North from Ministry of Unification: "We demands Immediate repatriation of the Yeonan 800."
Kim Jong Il and former U.S. President Bill Clinton meet in Pyongyang.	August 4	Former U.S. President Bill Clinton visits Pyongyang.
	August 5	Former President Clinton secures release of two female U.S. reporters detained by North and returns.
	August 10	Hyundai Asan CEO Hyun Jeong-eun visits Pyongyang.
North releases South Korean previously detained at Kaesong Industrial Complex as official expulsion.	August 13	
	August 15	President Lee Myung-bak announces new peace initiative for Korean Peninsula in Liberation Day (August 15) address .
Hyundai and North's Asia Pacific Peace Committee issue joint press release after Kim Jong Il and Hyundai Asan CEO Hyun Jeong-eun meets: * Resumption of Mt. Kumgang tours; normalization of MDL crossing and overnight stay; resumption of Kaesong tours; invigoration of Kaesong Industrial Complex; promotion of Mt. Baekdu tours; promotion of reunions for separated families during Chusok North's Panmunjom delegation: "North will retaliate mercilessly against South's UFG exercises."	August 16	
	August 20	ROK government proposes inter-Korean contact for reunion of separated families.
North lifts restrictions on land crossing through MDL and on stays. North sends funeral delegation to Seoul to pay condolences to bereaved family of former President Kim Dae-jung until August 23.	August 21	
	August 23	President Lee Myung-bak meets funeral delegation from North.
	August 26	Inter-Korean Red Cross Talks at Mt. Kumgang Hotel until August 28

The North	Date	The South
North notifies release of South Korean fishing vessel the Yeonan 800.	August 28	Both sides agree to reunion of separated families on Chusok during Inter-Korean Red Cross Talks.
	August 29	The Yeonan 800 returns to South.
Normalization of land crossing via Kyeongui Line, and communications line in Western corridor	September 1	
North's UN Ambassador Sin Son-ho sends letter to UN Security Council President, saying: "North is in final stage of its enrichment of uranium, and will reprocess and weaponize all of the plutonium produced."	September 4	
North opens Hwanggang dam floodgates without notification causing death of six South Korean campers.	September 6	
Telefax message to the South: "Water urgently discharged from the dam due to high water levels. Notice will be given in future when opening floodgates." Consultative Office for Inter-Korean Economic Cooperation resumes normal operations.	September 7	Telefax message to the North from Minister of Land, Transport and Maritime Affairs: "The Minister expresses deep regret and asks the North to explain over the tragic incident."
	September 8	ROK government demands for formal apology from North over death of South Koreans caused by North's abrupt release of water from Hwanggang Dam.
	September 21	President Lee Myung-bak proposes a "Grand Bargain" to the North .
	September 26	President Lee Myung-bak states clearly: "South denies North's status as nuclear power."
North's Vice Foreign Minister Park Gil-yon says: "North will respond in kind, dialogue for dialogue, nuclear deterrence for sanctions."	September 29	
11 North Koreans defect to South via East Sea	October 1	
Telefax message to the South: "Repatriation of North Korean defectors urged."	October 2	
Telefax message sends to South: "Repatriation of North Korean defectors strongly urged." North's UN Ambassador Sin Son-ho flatly rejects UN Security Council Resolution of A World without Nuclear Weapons.	October 8	Telefax message to the North: "11 North Koreans have confirmed desire to defect to South. North can verify their decisions upon request."
North test-fires five short-range missiles	October 12	ROK government proposes working-level contact for Inter-Korean talks * Discussions over prevention of tragic flood-related incidents on Imjin River and Red-Cross Talks

The North	Date	The South
Telefax message to the South: "Proposal for working-level contact is accepted."	October 13	
North expresses regret over death of South Koreans caused by its abrupt discharge of water into Imjin River and expresses condolences to the bereaved relatives Rodong Sinmun urges "resumption of Mt. Kumgang/ Kaesong tours."	October 14	Inter-Korean working-level contact for discussions of Imjin River floodings hand
North's Navy Command statement argues: "South Korean naval vessel intrudes into our territorial waters."	October 15	
Inter-Korean Red Cross working-level talks held * North's Red Cross formally asks South for humanitarian support	October 16	Inter-Korean Red Cross working-level talks
	October 19	ROK Government informs the North that it is ready to reconnect military communications line linking the two sides.
Telefax Message to the South: "North agrees on upgrading work for military communications line linking two sides."	October 20	
	October 26	ROK government offers to send 10,000 tons of corn and 20 tons of powdered milk
	October 28	South supplies materials required for connecting military communications line.
KCNA announcement: "The North has finished reprocessing 8,000 spent fuel rods for weaponization."	November 3	South's Foreign Ministry Spokesperson says: "North's reprocessing of spent fuel rods is clear violation of UN Security Council resolutions."
North's Supreme Command asks for apology from South and for measures to prevent recurrence of naval conflict	November 10	Daecheong naval campaign occurs in the West Sea
	November 11	Cheongwadae (the Blue House) spokesperson says: "South does not want Daecheong naval campaign to negatively impact inter-Korean relations."
North enforces currency reform.	November 30	
	December 8	U.S. special envoy Stephen Bosworth visits to the North until December 10.
North's Navy Command Spokesperson designates and declares "Peacetime maritime firing zone."	December 21	South's Navy Headquarters Spokesperson says: "The NLL has served as the effective sea border between the two Koreas for the past 50 years. The North should cease instigating acts that elevate tension near the NLL."

The North	Date	The South
	December 22	Military communications line installation completes .
North releases New Year's editorial. -Expresses its commitment to improving inter-Korean relations	January 1, 2010	
	January 4	President Lee Myung-bak delivers New Year's Speech: *Proposes establishment of inter-Korean liaison office and joint-recovery of unidentified remains of Korean War KIAs
North's Foreign Ministry statement: "North proposes meeting of Peace Treaty for signatories to 1953 Armistice Agreement state parties."	January 11	
North's UN Ambassador Sin Son-ho: "Lifting of all sanctions against the North is a precondition to the Six-Party Talks and meetings for the Peace Treaty at the same time."	January 12	South's Foreign Ministry Spokesperson announces: "It would be possible to start negotiations for a peace regime on the Korean Peninsula at a separate forum, if the Six- Party Talks resumes and the denuclearization of the North makes progress ."
Telefax message to the South: "South Korea should punish those flying leaflets into North Korea."	January 13	
North's Asia Pacific Peace Committee proposes working-level meeting for resumption of Mt. Kungang/ Kaesong tours.	January 14	
North's National Defense Commission Spokesperson warns: Concerning "a sudden changes surrounding the Korean Peninsula, the South's Ministry of Unification and the National Intelligence Service should be dismantled. The North will initiate a retaliatory holy war and exclude the South Korean authorities from all dialogue."	January 15	In response to warning from North's National Defense Commission, Ministry of Unification expresses deep regret over threatening remarks and actions based on unsubstantiated media reports.
North's Foreign Ministry Spokesperson says: "Sanctions against the North should be lifted prior to its return to the Six-Party Talks."	January 18	
	January 19	Meeting holds in Kaesong to evaluate inter-Korean joint inspection of foreign-invested industrial complexes until January 20
State Development Bank and Chosun Taepung International Investment Group established	January 20	South's Minister of National Defense warns: "The South would make a preemptive strike if it were ascertained that the North was preparing a nuclear attack."
Telefax message to the South: "North requests for military working-level talks."	January 22	

The North	Date	The South
CPRF Spokesperson threatens: "The South's Ministries of Unification, Foreign Affairs and Trade, and National Defense together with the National Intelligence Service are the Four <i>Gyeongin</i> (2010) Traitors."	January 23	
	January 25	Telefax message to the North: "We propose Inter-Korean working-level talks concerning Kaesong Industrial Complex on February 1, and subsequent military working-level talks."
North declares "no-sail zone" in the West Sea from January 25 to March 29 and proposes meeting with UNC about remains recovery of U.S. KIAs in its areas	January 26	Navy HQ Spokesperson says: "South urges North to stop unnecessary acts causing tension near the NLL and South reaffirms commitment to the defense of NLL."
North fires artillery rounds near NLL. General Staff announces "continuation of artillery firing exercises." UNC-KPA Working-level talks for remains recovery for U.S. KIAs. *North proposes resuming remains recovery for U.S. KIAs.	January 27	Telefax message to the North: "We strongly urge to halt unnecessary acts causing tension."
North fires artillery shots near NLL .	January 28	
North fires artillery shots near NLL .	January 29	
North announces five additional no-sail zones from January 31 to February 2.	January 31	
Fourth inter-Korean working-level talks for Kaesong Industrial Complex held * North points to the need to raise wages for its workers .	February 1	Fourth inter-Korean working-level talks for Kaesong Industrial Complex *South expresses regret over North's firing of artillery in the West Sea. The two sides agree to hold working-level military talks about the "3Cs."
North designates two maritime artillery firing zones near Baengnyeong and Daechong islands.	February 3	
North announces five additional artillery firing zones in West and East Seas, February 6-28.	February 4	
North's Ministry of People's Security and State Security issue joint statement denouncing attempt to overthrow the regime	February 8	
	February 12	Telefax message to the North: "We propose South-North military working-level talks to discuss the '3Cs' on February 23."
North designates artillery firing and no-sail zones in in the West and East Seas, February 20-22.	February 18	



The North	Date	The South
	February 20	Telefax message to North: "North's designation of no-navigation and artillery firing zones in West and East Seas an act of provocation in defiance of the Armistice Agreement and the Inter-Korean Non-Aggression Agreement."
Telefax message to the South: "We propose working-level military talks on March 2 in Kaesong."	February 22	
Telefax message to the South: "Kaesong is proper place for discussions in consideration of characteristics of the 3Cs." General Staff statement: "North denounces South's KR/FE exercises and signals mobilization of all attack and defensive capabilities, including nuclear, if required."	February 25	Telefax message to North: "North-proposes date of March 2 for military working-level talks accepted, but Panmunjom Peace House preferred venue."
Telefax message to the South: "We accept working-level contact on March 2 to discuss 3Cs."	February 28	Telefax message to North: "Kaesong accepts as venue for the talks, but talks should be a working-level contact between the authorities, not a military talks."
Inter-Korean working-level contact for discussion about 3Cs in regard to Kaesong Industrial Complex held * North asks for compliance with the June 15 and October 4 Declarations, cessation of confrontational and hostile acts against it, and compliance with existing agreements concerning 3Cs.	March 2	Inter-Korean working-level contact for discussions about the 3Cs in regard to Kaesong Industrial Complex *South demands North assure free crossing of South Koreans whenever needed through RFID technology, adopt selective inspection methods for more prompt customs clearance, and provide Internet and telecommunications services for mobile phones to ensure free communications.
North's Asia Pacific Peace Committee Spokesperson announces: "The North will scrap all existing projects and contracts, if the South blocks Mt. Kumgang/Kaesong tours."	March 4	
North's delegation to Panmunjom: -Denounces KR/FE exercises -Reiterates it would not be bound by Armistice Agreement and would counter any actions taken by South with its nuclear deterrence -Threatenes to end military dialogues with South and U.S.	March 7	
KCNA issues announcement, denouncing KR/FE exercises.	March 17	
North's Asia Pacific Peace Committee informs South that North would inspect South's real estate on Mt. Kumgang, starting March 25. * Also Mt. Kumgang tours would be handed over to new corporation if South failed to resume tours by April .	March 18	

The North	Date	The South
Bureau for Guiding the General Development of Tourist Resorts denounces South Korean authorities for blocking Mt. Kumgang/Kaesong tours	March 19	
Inspectors from North conducts survey over South's real estate on Mt. Kumgang.	March 25	
	March 26	The sinking of ROK Ship Cheonan
North's delegation to Panmunjom issues statement: "The South, by allowing civilians to tour the DMZ and reporters to have access to the DMZ for coverage, can be considered to be engaging in psychological warfare against the North. This could result in unexpected events."	March 29	
Bureau for Guiding the General Development of Tourist Resorts mentions: "The North will freeze South Korean government-owned assets such as the Mt. Kumgang Visitor Center and fire station for failure to allow real estate inspections."	March 31	Ministry of Unification Spokesperson expresses regret over unilateral measures taken by North.
North's delegation at Panmunjom urges to recover remains of U.S. soldiers killed during Korean War	April 5	
Bureau for Guiding the General Development of Tourist Resorts issues statement: Freezes South Korean government/KTO-owned assets on Mt. Kumgang; expels maintenance personnel; commences Mt. Kumgang tourism for Koreans and foreigners under new management; conducts all-out review of Kaesong Industrial Complex project	April 8	
Telefax message to the South notifies: "South Koreans passing through South-North JAA are also bringing leaflets into North Korea. North will reconsider implementation of military assurance of their safe crossing."	April 10	
	April 12	Telefax message to North: 'Adherence to June 4 Agreement.'
North takes measures to freeze South Korean real estate on Mt. Kumgang.	April 13	
KCNA broadcasts North's first official response to sinking of ROKS Cheonan: "It is a trick perpetrated by the South and have nothing to do with us."	April 17	
Director General Park Lim-su, Policy Bureau, National Defense Commission, conducts inspection tour of Kaesong Industrial Complex.	April 19	

The North	Date	The South
North's Foreign Ministry issues memorandum announcing "North would produce nuclear weapons as needed."	April 21	
Director General Park Lim-su, Policy Bureau, National Defense Commission, inspects South's real estate holdings on Mt. Kumgang, until April 23.	April 22	
Bureau for Guiding the General Development of Tourist Resorts Spokesperson issues statement: "The North will confiscate currently frozen South Korean government/KTO-owned assets."	April 23	
People's Army Chief of Staff Lee Yong-ho threatens: "We will destroy the enemy's stronghold completely, mobilizing all of our means, including our nuclear deterrence, if the enemy intrudes even 0.001 mm into our land, waters or air space."	April 24	
North takes measure to freeze South Korean real estate holdings on Mt. Kumgang	April 27	
Kim Jong Il visits China until May 7.	May 3	
North announces its successful nuclear fusion.	May 12	
Telefax message to South warns: "North will limit land crossing for South Koreans and take more substantial measures – harsher than merely stopping crossing – if Civilian Groups continue to spread leaflets in our territory."	May 16	
North's CPRF issues a "letter of charge" concerning ROKS Cheonan sinking * It is a planned and intentional provocation on the part of the South designed to ruin inter-Korean relations."	May 19	
National Defense Commission Spokesperson maintains that concerning the Cheonan incident, the NDC will dispatch an inspection team to the South Telefax message to the South urges its acceptance of visit.	May 20	Joint civil-military investigation group announces result of its investigation of the ROKS Cheonan incident .
CPRF Spokesperson argues that "The North regards the present situation as a state of war and will shut down all relations with the South, scrap the Inter-Korea Non-Aggression Agreement completely, stop all cooperative projects with the South, if the South takes countermeasures and retaliations."	May 21	Telefax message to North: "Cheonan attack violation of Armistice Agreement and South-North Basic Agreement. This provocative act will be dealt with within the framework of Armistice Agreement management system."
Telefax message to the South urges again that the South should accept visit of its inspection team.	May 22	

The North	Date	The South
<p>North's Central District Frontline Commander warns: "The North will conduct destructive firing directly at the South's psychological warfare facilities should the South activate one."</p>	<p>May 24</p>	<p>In response to Cheonan sinking, President Lee Myung-bak public statement: *Close Navigation Route; halt exchanges and cooperation with the North; invoke right to self-defense in event of armed invasion by North; refer incident to UN Security Council; and demand North to apologize and punish those involved in Cheonan attack South's Defense Minister announced measures to be taken against North: *Resumption of psychological warfare against the North; Closure of sea lanes for merchant ships; holding of ROK-U.S. joint anti-submarine exercises; and preparation for PSI-related maritime interdiction exercises within and outside the country's territorial waters</p>
<p>CPRF Spokesperson announces an 8-item statement on all-out severance of inter-Korean relations *Sever all relations with the South *Immediate end to all dialogue and contact with current South Korean Administration and government agencies during its term *Complete halt to all activities carried out by Red Cross liaison office at Panmunjom *Severing all communications channels with South *Closing Consultative Office for Inter-Korea Economic Cooperation and expelling South Koreans from the Kaesong Industrial Complex *Counterattack against South's anti-North psychological warfare *No crossing for South Korean ships/airplanes through North's territorial waters and airspace *Issues concerning relations with South handled as in state of war</p>	<p>May 25</p>	<p>Minister of National Defense: "South would invoke right to self-defense in event of North attacking South's psychological warfare equipment."</p>
<p>Telefax message to South threatens: "North will respond strongly, including blocking South Korean personnel and vehicles in the Western corridor from entering its territory, should South resume psychological warfare."</p>	<p>May 26</p>	<p>U.S. Secretary of State Hillary Clinton visits ROK: "The North Korean leaders responsible for the attack on ROKS Cheonan will be held accountable."</p>
<p>North's General Staff announces: *Reviewing complete ban on land crossing *Merciless countermeasures against South's anti-North psychological warfare *Invalidation of Agreement on Prevention of Incidental Collision in the West Sea *Cessation of International Maritime Merchant Vessel Network *Readiness for immediate physical retaliation against intrusions into territorial waters *Complete ban on crossing of South's ships, airplanes or other mobile means through territory, waters or airspace.</p>	<p>May 27</p>	

The North	Date	The South
NDC repels the Cheonan investigative report at international press conference saying that "The North renounces the findings of the South's investigation of the attack on the ROKS Cheonan." North holds a rally attended by about 100,000 people in Pyongyang.	May 28	
	May 30	MND issues statement refuting assertions from North's National Defense Commission.
North's Foreign Ministry Spokesperson says: "If the international community tries to refer the Cheonan attack to the UN Security Council, based solely on the findings of the South's unilateral investigation, the nefarious intent will be obviously demonstrated."	June 4	ROK government referred Attack against the ROKS Cheonan to UN Security Council.
CPRF Secretariat denounces UN Security Council for letter indicting North Korea's likely involvement in sinking of ROKS Cheonan.	June 6	
North's UN Ambassador Sin Son-ho denounces in his letter to UNSC President: "The North's inspection group should have been allowed to verify the findings of the South's investigation prior to the matter being discussed by the UN Security Council."	June 9	South finishes installing loudspeakers for psychological warfare against the North.
NDC states at a press conference: "The North will take merciless countermeasures against the South concerning the North's referral to the UNSC over the Cheonan incident."	June 11	
North's General Staff threatens in a "critical" announcement: "The South's resumption of psychological warfare is a direct declaration of war, and we will respond with a merciless military strike against the South that will turn Seoul into a sea of fire."	June 12	
	June 14	The South's Joint Civil-Military Investigation Group briefs UNSC on results of its investigation.
North's UN Ambassador Sin Son-ho mentions that "If UN moves to take measures against the North, North's military will take countermeasure."	June 15	
Chairman of Supreme People's Assembly, Choi Tae Bok argues that "The North will mercilessly strike sanctions with a merciless blow."	June 19	
	June 23	Defense Committee of National Assembly passes resolution denouncing North over ROKS Cheonan incident.

The North	Date	The South
	June 26	UNC proposes working-level talks for UNC-KPA General officer-Level Talks.
North rejects UNC proposal reiterating its insistence on dispatch of inspection team to the West Sea and proposes high-level inter-Korean military meeting.	June 27	South and U.S. announce agreement to postpone return of wartime operational control to the ROK military until end of 2015.
	June 28	Deputy Minister for Policy at ROK MND: "The North's proposal for a high-ranking South-North military meeting for discussing its dispatch of an inspection team was an attempt to invalidate the Armistice System."
	June 29	Plenary meeting of National Assembly adopts resolution denouncing North over ROKS Cheonan incident.
Letter to UNSC requests joint South-North investigation of the ROKS Cheonan incident .	June 30	
CPRF Spokesperson threatens that "The North is ready to wage a life and death struggle if the UNSC fabricates any form of slandering document targeting North."	July 7	
KCNA reports that "The North will not raise objects to the formality or method of the UNC-KPA General officer-level Talks so long as the military talks helps find truth about the ROKS Cheonan incident."	July 9	UNSC adopts presidential statement denouncing Cheonan attack.
North's Foreign Ministry Spokesperson argues that "The Six-Party Talks should be used to secure a Peace Treaty."	July 10	
North proposes rescheduling working-level talks for UNC-KPA General Officer-Level Talks to July 15 from July 13	July 13	
First working-level military talks for UNC-KPA General Officer-Level Talks held: *North insists it should have been allowed to dispatch inspection team prior to General-Level Military Talks.	July 15	First working-level military talks for UNC-KPA General officer-Level Talks: *South proposes UNC-KPA General officer-Level Talks .
Second working-level military talks for UNC-KPA General officer-Level Talks held: *North proposes composition and operation of Defense Committee inspection group. *Spokesperson for North's ARF threatens physical counter response to ROK-U.S. combined exercises.	July 23	Second working-level military talks for UNC-KPA General officer-Level Talks: *South urges North to observe Armistice Agreement and proposes formation of joint evaluation team.

The North	Date	The South
<p>NDC maintains:  North will counter ROK-U.S. combined exercise with strong nuclear deterrence;  North will launch retaliatory holy war at time of its choosing based on its nuclear deterrence; and North is not culpable in any way for ROKS Cheonan incident.</p>	<p>July 24</p>	
	<p>July 25</p>	<p>ROK-U.S. combined maritime exercise "Invincible Spirit" conducted (until July 28)</p>
<p>Kim Young-chun, North's Minister of the People's Armed Forces says that "The North will reinforce its nuclear deterrence in a new and developed way against the mounting U.S. threat."</p>	<p>July 26</p>	
<p>The third working-level talks for UNC-KPA General Officer-Level Talks held:  *North reiterates insistence on dispatch of its NDC inspection team.</p>	<p>July 27</p>	<p>The third working-level talks for UNC-KPA General officer-Level Talks:  *South says it would not accept North's dispatch of inspection team. The South explains its proposed procedures regarding a joint evaluation team. UNC Commander Walter Sharp says that Cheonan attack is clear violation of Armistice Agreement.</p>
	<p>August 1</p>	<p>Telefax message to North:  "South urges North to apologize for accidents caused by its landmines and to prevent the recurrence of similar accidents."</p>
<p>North's West District Frontline Commander threatens:  "The North will deal a physical blow to the South's plan to conduct a firing exercise in the West Sea."</p>	<p>August 3</p>	
<p>CPRF Secretariat threatens in a statement:  "The North will crush the South mercilessly with the most formidable means of attack and methods of warfare in response to the South's anti-submarine exercises in the West Sea."</p>	<p>August 5</p>	<p>South carries out anti-submarine exercises (until August 9).</p>
<p>Rodong Sinmun threatens that physical strike from North is more than a verbal warning.</p>	<p>August 7</p>	
<p>North seizes South Korean fishing vessel the Daeseung 55.</p>	<p>August 8</p>	
<p>North fires artillery shots to south of the NLL.</p>	<p>August 9</p>	

The North	Date	The South
The fourth working-level military talks for UNC-KPA General officer-Level Talks held: *North proposes to form a joint North-U.S. inspection group.	August 10	The fourth working-level military talks for UNC-KPA General officer-Level Talks: *UNC points out inappropriateness of name "a joint North-U.S. inspection group." Telefax message to North: "North's artillery shots in West Sea violation of Armistice Agreement and Non-Aggression Agreement."
	August 11	Telefax message to North's Red Cross asking for early repatriation of Daeseung-ho
North's General Staff threatens that "The North will counter South's UFG exercises with merciless military measures."	August 15	President Lee Myung-bak makes the following proposal in August 15 speech commemorating anniversary of country's 1945 liberation: *Proposed peaceful, economic unification under a community of one people. Proposed discussions on imposing unification tax
CPRF statement denounces that "South Korean President Lee Myung-bak's suggestion of a unification tax is tantamount to declaring full-blown hostilities against the North as it alludes to the possibility of an abrupt change in the North's situation."	August 17	
KCNA reports on the North's seizure of South Korean fishing vessel the Daeseung 55.	August 19	
	August 20	Telefax message to North's Red Cross: Again urges early repatriation of Daeseung.
Chairman Kim Yong-nam of the North's Standing Committee of the Supreme People's Assembly threatens that "The North will initiate a retaliatory holy war based on its nuclear deterrence in response to ROK-U.S. combined exercises."	August 25	Former U.S. President Jimmy Carter visits Pyongyang. *Returned to U.S. on August 27 with American missionary detained in North
Kim Jong Il visits China until August 30.	August 26	Telefax message to North's Red Cross: "South offers relief supplies for flood victims in North."
	August 31	U.S. announces administrative order for additional sanctions against North. Telefax message to North's Red Cross: "South offers relief supplies worth about KRW 10 billion upon North's request."
Telefax message to Korean Red Cross says that they accept proposal for provision of relief supplies *North requests rice, cement and construction equipment.	September 4	
Telefax message to Korean Red Cross announces "repatriation of fishing vessel the Daeseung 55 on September 7."	September 6	



The North	Date	The South
Telefax message to Korean Red Cross proposes "reunion of separated families on the occasion of Chusok."	September 10	
Telefax message to Korean Red Cross: "We agree to South's proposal of a meeting on September 17, and proposes the Mt. Chanam Hotel in Kaesong as location."	September 13	Telefax message to North's Red Cross: "Red Cross Working-level contact to discuss reunion of separated families proposed for September 17." *South decides to provide relief supplies (rice, cement and noodles) worth 10 billion won to North.
Telefax message to the South proposes "military working-level talks to be held on September 24."	September 15	
Fifth working-level military talks for UNC-KPA General officer-Level Talks: *North reiterates its insistence about the composition of North-U.S. joint inspection team.	September 16	Fifth working-level military talks for UNC-KPA General officer-Level Talks: *UNC proposes holding General officer-Level talks before carrying out joint inspection.
Inter-Korean Red Cross working-level talks *North proposes location and number of families be fixed later.	September 17	Inter-Korean Red Cross working-level talks *South proposed reunions take place on Mt. Kumgang.
	September 19	Telefax message to North: Proposed postponement of "military working-level talks to September 30."
	September 27	ROK-U.S. joint anti-submarine exercise (until October 1) in West Sea
Conference of Party Representatives to reappoint Kim Jong Il as General Secretary of Korean Workers' Party held: *Kim Jong-un, Kim Jong-il's third son, is elected as Central Member of the Party and Vice Chairman of Central Party Military Committee.	September 28	
38 <sup>th</sup> Inter-Korean Military Working-Level Talks held: *North asks South to stop its civilian groups from spreading leaflets and to have its naval vessels refrain from intruding into North Korean territorial waters.	September 30	38 <sup>th</sup> Inter-Korean Military Working-Level Talks: *South asks North to take responsible measures concerning ROKS Cheonan incident.
Inter-Korean Red Cross working-level talks held: *North urges the need for contact between authorities of the two sides for resumption of Mt. Kumgang tours.	October 1	Inter-Korean Red Cross working-level talks *Both sides agree to reunion of 100 separated families from each side to take place on Mt. Kumgang on October 30 through November 5.
Telefax message to South North's Bureau for Guiding General Development of Tourist Resorts proposes that "Working-level talks between authorities of two sides be held to discuss resumption of Mt. Kumgang tours."	October 2	

The North	Date	The South
Sixth working-level military talks for UNC-KPA General officer-Level Talks held: *North proposes joint investigation at Panmunjom followed by General Officer-Level Talks.	October 5	Sixth working-level military talks for UNC-KPA General officer-Level Talks: *South insists on holding General officer-Level Talks first, followed by joint inspection.
	October 13	South carries out first ROK-led PSI exercise (until October 14 in Busan).
Telefax message to the South (Bureau for Guiding General Development of Tourist Resorts) urges that "Early working-level talks between authorities from the two sides be held to discuss resumption of the Mt. Kumgang tours."	October 14	
Telefax message to the South threatens that "physical strike is imminent if South Koreans do not stop spreading leaflets in our territory."	October 15	
North informs South of resumption of communications between inter-Korean aviation authorities.	October 16	
Telefax message to the South proposes that "South-North Military Working-level Talks be held for discussions on pending military issues."	October 19	
	October 21	Telefax message to North: "North must take responsible steps concerning ROKS Cheonan incident before North-proposed South-North Military Working-Level Talks could be held. Agenda for said meeting should be disclosed."
Inter-Korean Red Cross Talks held until October 27 *North asks South to supply 500,000 tons of rice and 300,000 tons of fertilizer.	October 26	Inter-Korean Red Cross Talks (until October 27) *South proposes making family reunions regular occurrence
Seventh working-level military talks for UNC-KPA General officer-Level Talks held *North announces its position to discontinue the General Officer-Level Talks and blames UNC for breakdown in talks.	October 27	Seventh working-level military talks for UNC-KPA General officer-Level Talks
	October 28	Telefax message to North: "North's proposal for military working-level talks rejects." *North displayed consistent attitude concerning ROKS Cheonan attack.
Telefax message to the South says that "The South's rejection of our proposal for talks will result in painful outcome." *North fires shots at a mid-Eastern frontline GP. Shots concluded accidental.	October 29	

The North	Date	The South
NDC Inspection Group issues a "fact sheet" on the sinking of ROKS Cheonan	November 2	
Telefax Message to South (Bureau for Guiding the General Development of Tourist Resorts) urges "inter-Korean working-level talks on November 19 in order to discuss resumption of Mt. Kumgang tours."	November 11	G-20 Seoul Summit (until November 12)
North discloses uranium enrichment facility to Professor Siegfried Hecker, U.S. Nuclear Specialist of Stanford University.	November 12	
Telefax message to the South warns that "We will take an immediate physical action if a single artillery shell from the South falls on our sacred territorial waters." North fires artillery shots at Yeonpyeong Island. *North's Supreme Command announces that "The North Korean military has taken a courageous military step in responding to the South's military provocation."	November 23	Telefax message to North: "Cease shelling of Yeonpyeong Island immediately."  UNC proposes UNC-KPA General-Level Talks in regard to North's shelling of Yeonpyeong Island.  Ministry of Unification takes control of South Koreans visiting Kaesong Industrial Complex and stops supply of relief aid for flood victims in North.
North's Foreign Ministry announcement says: "North Korean military could strike South again at any moment."	November 24	South's Red Cross cancels Inter-Korean Red Cross Talks scheduled for November 25.
North's Panmunjom delegation rejects UNC's proposal for UNC-KPA General Officer-Level Talks concerning North's shelling of Yeonpyeong Island *North states that it will not hesitate to instigate second or third physical retaliatory strike against South if provoked again.	November 25	UNC informs North of plan for ROK-U.S. combined exercise between November 28 and December 1.
Rodong Sinmun threatens that "Those that provoke cannot avoid merciless punishment."	November 28	ROK-U.S. combined maritime exercise (until December 1) on West Sea Telefax message to North: "Accidental firing occurred near the MDL."

## Status of UN Peacekeeping Operations

(As of November 2010)

	Name of group	Stationing location	Stationing period	Major assignment	Number of those dispatched			
					Troops	Police	MEM (Military Experts on Mission)	Total
1	UNTSO	Palestine	May 1948-Present	Truce supervision and reconnaissance	-	-	152	152
2	UNMOGIP	Kashmir	January 1949-Present	Truce supervision and reconnaissance	-	-	42	42
3	UNFYCIP	Cyprus	March 1964-Present	Truce supervision and reconnaissance	859	68	-	927
4	UNDOF	The Golan Heights	June 1974-Present	Truce supervision and reconnaissance	1,043	-	-	1,043
5	UNIFIL	Lebanon	March 1978-Present	Truce supervision and reconnaissance	11,881	-	-	11,881
6	MINURSO	West Sahara	April 1991-Present	Truce supervision and election support	20	6	204	230
7	UNMIK	Kosovo	June 1999-Present	Support for peace and stability	-	8	8	16
8	UNAMA	Afghanistan	March 2002-Present	Peace building support	-	4	14	18
9	UNAMI	Iraq	August 2003-Present	Peace building support	221	-	12	233
10	UNMIL	Liberia	September 2003-Present	Truce supervision (surveillance) and reconnaissance	7,931	1,304	134	9,369
11	UNOCI	Cote-d'Ivoire	April 2004-Present	Peace building support	7,572	1,316	192	9,080
12	MINUSTAH	Haiti	June 2004-Present	Peace building support and reconstruction aid	8,651	3,146	-	11,797
13	UNMIS	Sudan	March 2005-Present	Truce supervision and stability building support	9,451	655	486	10,592
14	UNMIT	East Timor	August 2006-Present	Peace building support	-	1,485	33	1,518
15	BINUB	Burundi	January 2007-Present	Truce supervision	-	8	5	13
16	UNMIN	Nepal	January 2007-Present	Truce supervision	-	-	72	72
17	UNAMID	Darfur, Sudan	July 2007-Present	Truce supervision and peace building support	17,050	4,747	264	22,061
18	MINURCAT	Central Africa	September 2007-Present	Reconstruction aid	1,327	109	20	1,456
19	MONUSCO	The Democratic Republic of the Congo	May 2010-Present	Peace building support	17,112	1,181	715	19,008
<b>Total</b>					<b>83,118</b>	<b>14,037</b>	<b>2,353</b>	<b>99,508</b>

\* Source: [www.un.org/en/peacekeeping/contributors](http://www.un.org/en/peacekeeping/contributors)

Appendix 10

## Budget for ROK Military Units Dispatched Overseas

[Unit: Billion Won]

	The Dongmyeong Unit, Lebanon	The Cheonghae Unit, Somalia	The Danbi Unit, Haiti	The Ashena Unit, Afghanistan
2007	37.0	-	-	-
2008	19.6	-	-	-
2009	21.5	28.4	-	-
2010	22.9	34.2	28.2	47.1
<b>Total</b>	<b>101.0</b>	<b>62.6</b>	<b>28.2</b>	<b>47.1</b>

Appendix 11      **Status of Dispatch of ROK Troops Overseas**

[As of November 2010]

Name of the ROK military unit		Number of troops	Destination	Date of first dispatch	Period of rotation	
UN PKO	The Dongmyeong Unit, Lebanon	359	Tyre	July 2007	6 months	
	The Danbi Unit, Haiti	240	Leogane	February 2010		
	UN Military Observer Group in India and Pakistan (UNMOGIP)	9	Rawalpindi	November 1994	1 year	
	UN Mission In Liberia (UNMIL)	2	Monrovia	October 2003		
	UN Assistance Mission in Afghanistan (UNAMA)	1	Kabul	July 2003		
	UN Mission In Sudan (UNMIS)	7	Khartoum	January 2005		
	African Union – UN Hybrid Operation in Darfur (UNAMID)	2	Darfur	June 2009		
	UN Interim Force in Lebanon (UNIFIL)	Command staff	5	Nakura		January 2007
		Staff of the West Brigade	5	Tibnin, Al Janub		March 2008
	UN Mission in Nepal (UNMIN)	4	Kathmandu	February 2009		

Name of the ROK military unit		Number of troops	Destination	Date of first dispatch	Period of rotation	
UN PKO	UN Operation in Côte d'Ivoire (UNOCI)	2	Abidjan	July 2009	1 year	
	UN Mission for the Referendum in Western Sahara (MINURSO)	2	Laayoune			
	UN Stabilization Mission in Haiti (MINUSTAH)	2	Port-an-Prince	November 2009		
Sub total		640				
Multi-National Forces PO	The Cheonghae Unit off Somalia		306	The Gulf of Aden	March 2009	6 months
	The Ashena Unit, Afghanistan		232	Bagram	June 2010	
	Combined Maritime Forces	Staff officers	2	Manama	January 2008	1 year
		Coordination officer	1		Djibouti	March 2009
	CJTF - HOA	Coordination officers	3	Djibouti		February 2003
		Staff officer	1			
	Afghanistan	Information coordination officers	2	Bagram	June 2010	1 year
		CSTC - A staff officers	4	Kabul	June 2009	6 months
		Engineering coordination officer	1	Bagram	April 2010	Not fixed
	US Central Command	Coordination Group	2	Florida	November 2001	1 year
		Staff officer	1			
Sub total		555				
Grand total		1,195	17 areas			

## Status of Countries Participating in the International Security Assistance Force (ISAF)

[As of November 2010]

Country of origin	Number of troops dispatched	Country of origin	Number of troops dispatched	Country of origin	Number of troops dispatched
Georgia	924	Bosnia & Herzegovina	45	Jordan	0
Greece	80	Bulgaria	516	Ukraine	16
Norway	353	Belgium	491	Estonia	140
New Zealand	234	Sweden	500	Italy	3,688
Netherlands	242	Spain	1,576	Czech Republic	468
Germany	4,341	Slovakia	250	Canada	2,922
Denmark	750	Slovenia	78	Croatia	299
Latvia	189	Singapore	38	Turkey	1,790
Rumania	1,648	United Arab Emirates	35	Portugal	95
Luxembourg	9	Armenia	40	Poland	2,519
Lithuania	219	Iceland	4	France	3,850
The Former Yugoslav Republic of Macedonia	163	Ireland	7	Finland	150
Malaysia	30	Azerbaijan	94	Republic of Korea	246
Montenegro	31	Albania	258	Hungary	502
Mongolia	47	United Kingdom	9,500	Australia	1,550
United States	90,000	Austria	3	Total	130,930

# The Act on Participation in UN Peacekeeping Operations

## Article 1 (Purpose)

The purpose of this Act is to allow the Republic of Korea to participate in UN Peacekeeping Operations more expediently and actively to contribute to creating and maintaining world peace by stipulating the matters concerning the dispatch and withdrawal of military units taking part in UN Peacekeeping Operations.

## Article 2 (Definition)

The terms used in this Act shall have the following meanings:

1. "The United Nations (UN) Peacekeeping Operations (PKO)" (hereinafter "Peacekeeping Operations (PKO)") refers to a series of activities, including support for the execution of peace treaties, surveillance of armistice agreements, maintenance of public order and stability, support for elections, humanitarian relief, and support for rehabilitation, reconstruction and development, which are carried out in specific countries (or regions) , under the control of the commander appointed by the UN Secretary-General, in accordance with a resolution adopted by the UN Security Council, financed by the UN. However, Peacekeeping Operations, or other military activities, carried out independently by an individual country or a group of countries, under the approval of the UN, shall not be included herein.
2. A "dispatched military unit" refers to a country's military unit (not including a group or a coalition of uniformed service people carrying out activities on an individual basis) that has been dispatched out of the country for participation in a PKO.
3. "Participating personnel" refers to uniformed service people (not including those belonging to a dispatched military unit), the police, and other governmental personnel or civilians that have been dispatched out of the country for participation in a PKO.
4. "Disaster damage" refers to the losses and/or damage incurred by disaster (including terrorist acts) under 「the Framework Act on the Management of Disasters and Safety」 , Article 3, Paragraph 1.

## Article 3 (Establishment and Operation of Standing Units)

- ① The Government may establish and operate a military unit that is ready at all times for dispatch out of the country for participation in a PKO (hereinafter a "standing unit").
- ② The matters concerning the establishment and operation of a standing unit, as stated in the foregoing Paragraph ①, shall be fixed under the relevant presidential decree.



#### **Article 4 (Basic Principles of Performance of Duties)**

Dispatched military units and participating personnel shall observe international laws and carry out their duties in good faith in accordance with the rights endowed by the UN and the relevant guidelines.

#### **Article 5 (Decision on Participation in a PKO)**

- ① When the UN requests the ROK's participation in a PKO, the Foreign Minister shall inform the National Defense Minister of the request, and the two shall discuss the matters concerning the dispatch, including the dispatch of a standing unit.
- ② For the dispatch of a standing military unit, the Government shall dispatch a team of investigators to the relevant country or region to ascertain the overall local situation, including the local political situation and safety-related matters. A report on the situation (hereinafter "a local situation investigation report") will then be drawn up.
- ③ The Government shall make a decision on whether to accept the UN's request; and determine the purpose and period of the dispatch, along with the size and mission of the dispatched military unit through deliberation at a cabinet meeting and on the approval of the President.

#### **Article 6 (National Assembly's Consent to Dispatch a Military Unit)**

- ① The Government's dispatch of a military unit to a foreign country for a participation in PKO requires the prior consent of the National Assembly.
- ② When the government submits its request for dispatch to the National Assembly in accordance with the foregoing Paragraph ①, it shall attach the following:
  1. The local situation investigative report.
  2. Information on the destination.
  3. Explanation on why a military unit needs to be dispatched.
  4. The size of the dispatched unit.
  5. The period of the dispatch.
  6. The mission of the dispatched unit.
  7. Other information related to the dispatch of ROK military units stipulated under the presidential decree.
- ③ The Government may reach a tentative agreement with the UN, on each item stated in the foregoing Paragraph ②, for the dispatch of a military unit whose number of troops does not exceed 1,000 (One thousand), including those already dispatched, for a PKO that meets all of the following requirements:
  1. When the recipient country has consented to the relevant PKO.
  2. When the period for dispatch does not exceed one year.
  3. When the unit is to be engaged in a non-military mission, such as humanitarian support or support for reconstruction, or it is judged that there is only a slim possibility of direct involvement in actual combat or of use of armed forces while carrying out the duty.

4. When the UN requests prompt dispatch.

#### **Article 7 (Dispatch of a Military Unit)**

- ① In the event of the dispatch of a military unit for a PKO, with the consent of the National Assembly, as stated in Article 6 herein, the Government shall do its best to ensure the prompt dispatch of a standing unit in close cooperation with the UN and the governments of the relevant countries.
- ② The Foreign Minister shall discuss with the Minister of National Defense and promote cooperation following the foregoing Paragraph ① and sign the relevant international agreement.
- ③ The Defense Minister shall prepare and implement the detailed guidelines and procedures concerning the dispatch of a military unit for a PKO after determining the appropriate type and size of the unit.

#### **Article 8 (Extension of the Period of Dispatch)**

- ① When there is a need to extend the period of dispatch of a military unit, the Government shall obtain the prior consent of the National Assembly.
- ② In principle, the extension stated in the foregoing Paragraph ① shall be for a year. Concerning the government's submittal of its request for an extension to the National Assembly, Article 6, Paragraph ②, shall apply *mutatis mutandis*.

#### **Article 9 (End of Dispatch)**

The Government may bring to an end the dispatch of a military unit if one of the following is applicable:

1. The mission assigned to the dispatched unit is completed.
2. Operating a dispatched military unit is decided to be no longer required prior to the end of the period of dispatch.

#### **Article 10 (Demand for the End of Dispatch)**

- ① The National Assembly may demand the Government through a resolution for a dispatch to be brought to an early end, even if the military unit has not completed its assigned mission or its period of dispatch.
- ② The Government shall comply with the demand for the end of dispatch from the National Assembly stated in the foregoing Paragraph ① unless there is a special reason not to.

#### **Article 11 (Report on Activities to the National Assembly)**

The Government shall submit a detailed report on any change to the unit, including activity achievement, activity status, end of mission, and withdrawal of dispatched military unit to the annual regular session of the National Assembly.

#### **Article 12 (Education and Training)**

Heads of each central government agency may entrust or send government employees participating in PKO to a relevant institution, either in or out of the country, for the education or training so that they may be equipped with

the quality and ability required as participating personnel.

**Article 13 (Guarantee of Status of, and No Disadvantageous Treatment of, Participating Personnel)**

- ① Participating personnel shall not be subject to any disadvantageous treatment due to their past or ongoing participation in a PKO.
- ② A government official (including an active-duty service person or police officer) taking part in a PKO shall be deemed to hold a dual status, i.e., as a member of a PKO and an ROK Government official.
- ③ All Korean civilians participating in a PKO shall be deemed to hold a dual status, i.e., as a member of a PKO and an ROK citizen. They will receive every measure of protection under international law.

**Article 14 (Payment of Allowance)**

The Government may pay an allowance to participating personnel, in accordance with what is stipulated in the relevant laws, in consideration of the work environment of the dispatched area and the nature of the mission.

**Article 15 (Prevention of Accidents/Disaster Damage)**

The Government shall prepare and implement disaster damage preventing measures and comprehensive measures for safety protection and prevention of accidents of the dispatched military service members and participating personnel.

**Article 16 (Installation and Operation of PKO Policy Consultation Meetings)**

- ① The Ministry of Foreign Affairs and Trade (MOFAT) shall operate a PKO Policy Consultation Meeting (hereinafter "Policy Consultation") for efficient execution of government PKO policies and to ensure collaboration and coordination between the relevant ministries.
- ② The Policy Consultation stated in the foregoing ① shall be comprised of 10 (ten) or less members, including the Chair, which shall be assumed by the Foreign Minister.
- ③ The Government shall operate a working-level committee comprised of senior officials from the central government agencies concerning the Policy Consultation. This committee shall be chaired by the Vice Foreign Minister.
- ④ Other details concerning the composition and operation of the Policy Consultation and working-level committee shall be regulated by the presidential decree.

**Additional Rule <Law No. 9939 dated January 25, 2010>**

- ① (Date of implementation) This Act shall take effect from the day following the elapse of 3 (three) months after promulgation.
- ② (Interim measures) All military units and service members, police officers, and civilians dispatched for participation in a PKO, prior to the implementation of this Act, shall be deemed to have been dispatched under this Act.

# Joint Communiqué

## The 41<sup>st</sup> ROK-U.S. Security Consultative Meeting

October 22, 2009, Seoul

1. The 41<sup>st</sup> Republic of Korea–United States Security Consultative Meeting(SCM) was held in Seoul on October 22, 2009. ROK Minister of National Defense Kim, Tae Young and U.S. Secretary of Defense Robert M. Gates led their respective delegations, which included senior defense and foreign affairs officials. Before the SCM, the Chairman of the ROK Joint Chiefs of Staff, General Lee, Sang-eui and the Chairman of the U.S. Joint Chiefs of Staff, Admiral Michael G. Mullen, presided over the 31<sup>st</sup> ROK-U.S. Military Committee Meeting (MCM) on October 21, 2009.
2. The Minister and the Secretary reaffirmed the commitment of the ROK and U.S. Presidents to build a comprehensive strategic Alliance of bilateral, regional and global scope, based on common values and mutual trust, asset forth in the Joint Vision for the Alliance of the ROK and the U.S. on June 16, 2009. They also agreed to closely cooperate to implement and build upon the Joint Vision through continued development of measures for the direction of ROK-U.S. defense cooperation, thereby further strengthening the Alliance for the 21<sup>st</sup> Century.
3. The Minister and the Secretary reiterated that the ROK and the U.S. will not accept North Korea as a nuclear weapon state. They discussed North Korea’s missile and nuclear tests in April and May 2009 and recent short-range ballistic missile launches. The Minister and the Secretary reaffirmed these acts clearly violate UN Security Council resolutions and Six-Party Talks agreements ; undermine the global non-proliferation regime; and constitute direct and grave threats to peace and stability not only for the ROK and regional neighbors, but also the entire international community. The Minister and the Secretary agreed to closely cooperate on the full and faithful implementation of UN Security Council resolutions 1718 and 1874, and to continue joint efforts to achieve the complete and verifiable denuclearization of North Korea in peaceful manner through the Six-Party Talks.
4. Secretary Gates reiterated his support for the ROK Government’s efforts to reduce tensions on the Korean Peninsula and develop inter-Korean relations for mutual benefits and common prosperity through dialogue, while making the denuclearization of North Korea a top priority. The Minister and the Secretary agreed to further strengthen defense cooperation, ensuring combined readiness to effectively address future

challenges and emerging needs in the security environment. They reaffirmed the important role that the ROK-U.S. Alliance has in maintaining peace and stability on the Korean Peninsula.

5. The Minister and the Secretary reaffirmed the two nations' mutual commitment to the fundamental mission of the Alliance to defend the Republic of Korea through a robust combined defense posture, as well as to the enhancement of mutual security based on the Mutual Defense Treaty. They also agreed that the ROK-U.S. Alliance remains vital to the future interests of both nations in securing peace and stability on the Korean Peninsula and in Northeast Asia, and stressed their determination to ensure sufficient capabilities of the combined forces for the security of the Republic of Korea. Secretary Gates reiterated the firm and unwavering U.S. commitment to the defense of the ROK using both capabilities postured on the Korean Peninsula and globally available U.S. forces and capabilities that are strategically flexible to deploy to augment the combined defense in case of crisis. Minister Kim and Secretary Gates acknowledged this commitment is further demonstrated and strengthened by extending and normalizing tour lengths for all service members assigned to Korea to three years, along with the commitment to maintain the current U.S. troop level in Korea.
6. Secretary Gates reaffirmed the U.S. commitment to provide extended deterrence for the ROK, using the full range of military capabilities, to include the U.S. nuclear umbrella, conventional strike, and missile defense capabilities. Minister Kim conveyed his appreciation for the U.S. commitment and both sides agreed to work closely together to enhance the effectiveness of extended deterrence.
7. The Minister and the Secretary agreed to consult closely on the future combined force posture, making enhancements as necessary, to ensure that robust forces and capabilities are available to deter aggression against the ROK and defend against that aggression should deterrence fail. They also agreed to cooperate to maintain appropriate preparedness to implement the shared vision of regional and global contribution in support of mutual security interests.
8. The Minister and the Secretary agreed that the ROK-U.S. Alliance plays a significant role in fostering the peace, stability and prosperity in the region. They further agreed to work jointly to develop cooperative relations and to promote multilateral security cooperation in the region and globally, highlighting the important role that regional partners play in helping advance mutual interests of both the ROK and the U.S.
9. The Minister and the Secretary agreed that the ROK and the U.S. will continue to enhance close Alliance cooperation to address wide-ranging global security challenges of mutual interest, including through peacekeeping activities, stabilization and reconstruction efforts, humanitarian assistance, and disaster relief. In this regard, Secretary Gates expressed appreciation for the ROK's continued support to promote peace and stability in areas such as the Gulf of Aden and Lebanon. Minister Kim also expressed his appreciation for

the U.S.' active support to enable the Korean military unit deployed to the Gulf of Aden to successfully conduct its missions. Secretary Gates noted with appreciation the Korean government's May 26, 2009 endorsement of and participation in the Proliferation Security Initiative (PSI) as a significant demonstration of cooperation in the global effort to prevent the proliferation of weapons of mass destruction (WMD), acknowledging the importance of mutual support and cooperation on PSI-related activities, including exercises and information -sharing.

10. The Minister and the Secretary received a report on the results of the ROK-U.S. Military Committee Meeting from the Commander of the ROK-U.S. Combined Forces Command (CFC), General Walter L. Sharp, which highlighted that the combined defense posture is capable and ready to "Fight Tonight," and that it is prepared to effectively respond to any threat or provocation.
11. Having agreed with the CFC Commander's report that the transition of wartime operational control (OPCON) of ROK military forces is proceeding smoothly and on schedule, and in accordance with the Strategic Transition Plan (STP), the Minister and the Secretary reaffirmed their intent for the transition to occur on April 17, 2012. They also reaffirmed that the implementation of the STP will be regularly assessed and reviewed at the annual SCM/MCM, with a close eye on North Korean threats, and reflected in the transition process. In this regard, they further noted the importance of the OPCON Certification Plan in ensuring the transition is implemented methodically to validate that the combined defense posture remains strong and seamless. The Minister and the Secretary praised the successful results of the Ulchi Freedom Guardian (UFG) exercise held in August 2009 as a demonstration of the capabilities of the ROK Joint Chiefs of Staff in leading the combined war fight. The Minister and the Secretary agreed to receive Interim Certification Reports and Final Certification Report at the SCMs until the transition is completed.
12. To ensure that the combined defense remains robust, the Secretary reaffirmed that the U.S. will provide specific and significant bridging capabilities until the ROK obtains full self-defense capabilities. Secretary Gates further noted the U.S. commitment to contribute U.S. enduring capabilities to the combined defense for the life of the Alliance. Additionally, the Minister and the Secretary agreed that the two militaries have made substantial progress on the development of military plans and strategic documents related to a range of situations to ensure the combined defense is prepared for an effective response. They agreed to continually conduct combined exercises for the maintenance, development, and readiness of a strong combined defense posture, both during the transition of wartime OPCON as well as afterwards.
13. The Minister and the Secretary received a report on the results of the ROK-U.S. Security Policy Initiative (SPI) meetings over the past year, and expressed satisfaction that, through close consultations, the ROK and

the U.S. are making significant progress on important issues in further developing the Alliance, including: ensuring an effective combined defense, proceeding with the implementation of U.S. Forces Korea (USFK) relocation and camp returns, and articulating a shared future vision for the Alliance. The Minister and the Secretary agreed to continue SPI consultations in 2010 and beyond, based on the significant accomplishments of the past five years and the mutual desire to continue to enhance the ROK-U.S. Alliance.

14. The Minister and the Secretary acknowledged the progress on USFK base relocation and camp returns. The Minister and the Secretary agreed to work closely together to complete successfully base relocation and camp returns, noting that the efficient and effective completion of these cooperative joint efforts are in the best interest of both nations. The Minister and the Secretary agreed to minimize challenges and to strive for rapid completion of the Yongsan Relocation Plan (YRP) and Land Partnership Plan (LPP). The Minister and the Secretary expressed satisfaction with the agreement on the Joint Environmental Assessment Procedure (JEAP), established in March 2009 to facilitate bilateral cooperation for camp returns, noting that the JEAP is expected to be successfully applied to complete the return of seven facilities, including Camp Hialeah, by the end of the year.
15. The Minister and the Secretary expressed satisfaction with the 8<sup>th</sup> Special Measures Agreement (SMA), signed on January 15, 2009, effective from 2009 to 2013. Secretary Gates offered his appreciation to the ROK, emphasizing that the ROK's host nation support significantly contributes to a stable stationing environment for USFK. The Minister and the Secretary shared the view that the new SMA will play an important role in enhancing the combined defense posture and strengthening the Alliance. Both sides agreed to work closely together to implement the recently agreed in-kind contribution program.
16. Secretary Gates expressed sincere appreciation to Minister Kim for the courtesy and hospitality extended to him and his delegation by the Government of the Republic of Korea, and for the excellent arrangements which contributed to the success of the meeting. The Minister and the Secretary agreed that the discussions during the 41<sup>st</sup> SCM and 31<sup>st</sup> MCM contributed substantively to strengthening the ROK-U.S. Alliance and further enhanced the development of the bilateral defense relationship into a comprehensive strategic Alliance. Both sides agreed to hold the 42<sup>nd</sup> SCM in Washington, D.C. at a mutually convenient time in 2010.

## Joint Communiqué

### The 42<sup>nd</sup> U.S.-ROK Security Consultative Meeting

October 8, 2010, Washington D.C.

1. The 42<sup>nd</sup> United States – Republic of Korea Security Consultative Meeting (SCM) was held in Washington D.C. on October 8, 2010. U.S. Secretary of Defense Robert M. Gates and ROK Minister of National Defense Kim, Tae Young led their respective delegations, which included senior defense and foreign affairs officials. Before the SCM, the U.S. Chairman of the Joint Chiefs of Staff, Admiral Michael G. Mullen and the ROK Chairman of the Joint Chiefs of Staff, General Han, Min Koo, presided over the 32<sup>nd</sup> U.S.-ROK Military Committee Meeting (MCM) on October 7, 2010.
2. The Secretary and the Minister reaffirmed the commitment of the U.S. and ROK Presidents to build a comprehensive strategic Alliance of bilateral, regional, and global scope, based on common values and mutual trust, as set forth in the June 2009 Joint Vision for the Alliance of the ROK and the U.S. They also reaffirmed their shared view expressed at the ROK-U.S. Foreign and Defense Ministers' Meeting in July that the scope of Alliance cooperation should continue to broaden and deepen to encompass both closer security cooperation and more comprehensive cooperation in other areas.
3. The Secretary and the Minister reaffirmed their shared view expressed at the ROK-U.S. Foreign and Defense Ministers' Meeting in July that both sides acknowledged the close bilateral cooperation regarding the North Korean nuclear issue, and urged North Korea to carry out the complete and verifiable abandonment of all its nuclear programs and pursuit of nuclear weapons and demonstrate through concrete actions its genuine will to denuclearize. They reiterated that the ROK and the U.S. will not accept North Korea as a nuclear weapon state. The Secretary and the Minister also confirmed that they would continue to cooperate closely on the implementation of UN Security Council resolutions 1718 and 1874 as well as unilateral sanctions against North Korea.
4. The Secretary and the Minister reaffirmed that North Korean aggression and provocation are not to be tolerated and that the U.S. and ROK intend to work shoulder to shoulder to demonstrate our combined resolve. They also reaffirmed their shared view that the ROK ship Cheonan was sunk by a North Korean attack, and welcomed the publication of the final joint investigation report on the Cheonan incident, as well as a special report prepared by the United Nations Command on the special investigation of the sinking of Cheonan, which was submitted to and formally circulated as an official document of the UN Security Council.



They further discussed North Korean military activity in the post-Cheonan security environment as well as countermeasures that include U.S.-ROK Combined Exercises on the peninsula and in the East and West Seas. Both sides agreed to increase the combined watch activities on the North Korean situation, especially leading up to the G20 Summit in Seoul this year. The Secretary and the Minister reaffirmed that close continued bilateral planning for various situations, as well as an extensive combined training and exercises, were critical to adequately prepare for future challenges on the peninsula.

5. The Secretary and the Minister reaffirmed the two nations' mutual commitment to the fundamental mission of the Alliance to defend the Republic of Korea through a robust combined defense posture, as well as to the enhancement of mutual security based on the Mutual Defense Treaty. They also reaffirmed that the U.S.-ROK Alliance remains vital to the future interests of both nations in securing peace and stability on the Korean Peninsula and in Northeast Asia, and stressed their determination to ensure sufficient capabilities of the combined forces for the security of the Republic of Korea. Secretary Gates reiterated the firm and unwavering U.S. commitment to the defense of the ROK using both capabilities postured on the Korean Peninsula and globally available U.S. forces and capabilities that can deploy to augment the combined defense in case of crisis. Secretary Gates and Minister Kim acknowledged that the U.S. commitment is to be further demonstrated and strengthened by extending and normalizing tour lengths for all service members assigned to Korea, along with the commitment to maintain the current U.S. troop level in Korea.
6. Secretary Gates reaffirmed the continued U.S. commitment to provide and strengthen extended deterrence for the ROK, using the full range of military capabilities, to include the U.S. nuclear umbrella, conventional strike, and missile defense capabilities. Moreover, the Secretary and the Minister agreed to institutionalize an Extended Deterrence Policy Committee, which will serve as a cooperation mechanism to enhance the effectiveness of extended deterrence.
7. The Secretary and the Minister pledged that the ROK and the U.S. are to continue to enhance close Alliance cooperation to address wide-ranging global security challenges of mutual interest, including through peacekeeping activities, stabilization and reconstruction efforts, humanitarian assistance, and disaster relief. Secretary Gates expressed appreciation for the ROK's past contribution in Iraq as well as the recent contribution that the ROK has made in Afghanistan through the deployment of their Provincial Reconstruction Team this year. The Secretary also positively remarked on the ROK's contribution to Haiti disaster relief operations, its anti-piracy efforts in the Gulf of Aden, as well as contribution to UN mission in Lebanon. He also expressed appreciation for the Korean government's continued active participation in the Proliferation Security Initiative (PSI). In particular, ROK's hosting of the PSI Exercise Eastern Endeavor 10 later this month is expected to be a significant step forward in the global cooperative effort to prevent the proliferation of weapons of mass destruction (WMD).

8. The Secretary and the Minister received a report on the results of the U.S.-ROK Military Committee Meeting from the Commander of the ROK-U.S. Combined Forces Command (CFC), General Walter L. Sharp, which highlighted that the combined defense posture is capable and ready to "Fight Tonight," and that it is prepared to effectively respond to any provocation, instability or aggression.
9. The Secretary and the Minister received a report on the results of the ROK-U.S. Security Policy Initiative (SPI) meetings over the past year, and expressed satisfaction that, through close consultations, the ROK and the U.S. are making significant progress on important issues in further developing the Alliance, including: ensuring an effective combined defense, proceeding with the implementation of U.S. Forces Korea (USFK) relocation and camp returns, and articulating a shared future vision for the Alliance. The Secretary and the Minister pledged to continue SPI consultations in 2011 and beyond, based on the significant accomplishments of the past six years and the mutual desire to continue to enhance the U.S.-ROK Alliance.
10. The Secretary and the Minister confirmed a comprehensive strategy to strengthen the Alliance in years to come, including achieving the transition of wartime operational control(OPCON) for the combined warfight to the ROK Joint Chiefs of Staff in 2015. The transition of OPCON should sustain and enhance the Alliance's combined defense posture and capabilities, and support both the Alliance's bilateral defense priorities and its future development. The Secretary and the Minister affirmed and signed the Strategic Alliance 2015, which provides the framework for the transition of OPCON to the ROK Joint Chiefs of Staff over the next five years. The Secretary and Minister reaffirmed their intent for the transition to occur in December 2015. They also reaffirmed that the implementation of the Strategic Alliance 2015 plan is to be regularly assessed and reviewed at the annual SCM/MCM, paying particular attention to evolving North Korean threats, and reflected in the transition process. In this regard, they further noted the importance of the OPCON Certification Plan in ensuring the transition is implemented methodically to validate that the combined defense posture remains strong and seamless. The Secretary reaffirmed that the U.S. will provide specific and significant bridging capabilities until the ROK obtains full self-defense capabilities, and further noted the U.S. commitment to contribute enduring capabilities for the life of the Alliance.
11. The Secretary and the Minister acknowledged the progress on USFK base relocation and camp returns. They committed to work closely together to successfully complete base relocation and camp returns, noting that the efficient and effective completion of these cooperative joint efforts is in the best interest of both nations. The Secretary and the Minister pledged to minimize challenges and to strive for rapid completion of the Yongsan Relocation Plan (YRP) and Land Partnership Plan (LPP). The two also concurred that the Joint Environmental Assessment Procedure (JEAP) is useful in facilitating bilateral cooperation for camp returns.

12. The Secretary and the Minister affirmed and signed the Guidelines for U.S.-ROK Defense Cooperation, a document that seeks to embody the future vision of the U.S.-ROK Alliance, as agreed through the Joint Vision Statement last year and based on the ROK-U.S. Mutual Defense Treaty of 1953. They confirmed that the guidelines provide the future direction of the U.S.-ROK defense relationship to strengthen our combined defense and strategic contribution to the regional and global security in the 21st century.
13. The Secretary and the Minister affirmed and signed the Strategic Planning Guidance which provides the U.S.-ROK Military Committee with the strategic guidance and authorization necessary to direct the development of operational planning. The Secretary and the Minister confirmed that this strategic planning guidance was a useful measure in deterring a wide range of threats against the Republic of Korea and establishing military preparation plans. The Secretary and the Minister noted that the two militaries have made substantial progress in the development of military plans related to a range of situations on the Korean Peninsula and that this document is to further ensure an effective Alliance response to potential crisis.
14. Minister Kim expressed sincere appreciation to Secretary Gates for the courtesy and hospitality extended to him and his delegation by the U.S. Government, and for the excellent arrangements which contributed to the success of the meeting. The Secretary and the Minister affirmed that the discussions during the 42<sup>nd</sup> SCM and 32<sup>nd</sup> MCM contributed substantively to strengthening the U.S.-ROK Alliance and further enhanced the development of the bilateral defense relationship into a comprehensive strategic Alliance. Both sides expect to hold the 43<sup>rd</sup> SCM in Seoul, ROK at a mutually convenient time in 2011.

# The Guidelines for ROK-U.S. Defense Cooperation

October 8, 2010

## **I. Purpose of the Guidelines**

The Ministry of National Defense of the Republic of Korea (ROK MND) and the Department of Defense of the United States of America (U.S. DoD) herein establish a set of guidelines that develop the future direction of the ROK-U.S. defense relationship. As discussed in the Joint Statement of the July 2010 ROK-U.S. Foreign and Defense Ministers' Meeting in Seoul, these guidelines are based on and serve to advance the Joint Vision Statement of June 16, 2009 and the U.S.-ROK Mutual Defense Treaty signed on October 1, 1953.

Commemorating the 60<sup>th</sup> anniversary of the outbreak of the Korean war this year, the ROK-U.S. Alliance remains firmly rooted in our bilateral commitment to provide mutual security, which has ensured peace and stability on the Korean Peninsula and in Northeast Asia for nearly six decades. Standing on a foundation of the shared sacrifices and deep bonds from the alliance's past, our defense relationship is also growing into a comprehensive strategic alliance for the future. As this alliance matures, our two countries will continue to pursue fully the principles and objectives of our mutual and common defense that are reflected in the Mutual Defense Treaty: to promote peace, defend against external threats, and strengthen efforts for collective defense and the preservation of regional peace and security.

## **II. Strengthening the Alliance**

The ROK MND and the U.S. DoD intend to strengthen our alliance's strategic contribution to regional and global security in the 21st century.

In support of the June 2010 bilateral presidential decision and supporting defense consultations, both countries are fully committed to completing the transition of wartime operational control from the ROK-U.S. Combined Forces Command to the ROK JCS on December 1, 2015, with synchronization of the transition and other related alliance defense initiatives in accordance with the Strategic Alliance 2015. This synchronization effort and the transition process will occur through deliberate, bilateral whole-of-government coordination.

The ROK MND and the U.S. DoD, standing shoulder-to-shoulder, will continue to maintain a robust combined defense posture to deter and defeat any North Korean and other threats and enables future peaceful reunification of the Korean Peninsula, based on democratic values and a market economy.

Our Alliance will remain vigilant and ready to address the uncertainties of the future security environment on the Korean Peninsula, while it builds a comprehensive strategic alliance of bilateral, regional and global scope, based on common values and mutual trust.

The ROK MND and the U.S. DoD reaffirm the full scope and extent of Treaty commitments. The United States will continue to uphold its firm resolve in its commitment to the defense of the Republic of Korea, maintaining a U.S. military presence on the Korean Peninsula that, together with ROK forces, deters North Korean aggression. This commitment is demonstrated by the enduring U.S. force presence through our normalization, the provision of bridging and enduring capabilities as well as augmentation forces in contingencies, and the continued provision of extended deterrence.

After the transition of wartime operational control, the Republic of Korea is to take the lead in the combined defense of its country while steadfastly adhering to its commitments to the Mutual Defense Treaty.

### **III. Combined Defense of the Republic of Korea**

ROK Armed Forces and the U.S. Forces in Korea are to continue to enhance the combined defense posture prior to and following the transition of wartime operational control, thereby strengthening deterrent capabilities on the Korean Peninsula. The United States is committed to providing extended deterrence for the ROK, using the full range of U.S. military capabilities, including the nuclear umbrella, conventional strike, and missile defense capabilities.

North Korea's nuclear weapons technology and ballistic missile development, production, possession, and proliferation are grave threats to peace and stability on the Korean Peninsula as well as around the world. Both Alliance partners reaffirm our policy of seeking a complete and verifiable denuclearization of North Korea.

Pursuant to the Mutual Defence Treaty the ROK MND and the U.S. DoD are to continue close cooperation in managing the threats North Korea poses in the post-CHEONAN security environment and in developing Strategic Communication messages.

In order to meet the broad strategic vision for the Alliance, both the ROK MND and the U.S. DoD will undertake to implement the following set of enabling measures necessary for an effective combined defense posture:

- *Enhance intelligence and information sharing*, which will serve as the basis for ensuring combined readiness, planning, and operations. Both Alliance partners will also sufficiently safeguard shared intelligence to ensure national security;
- *Strengthen operational planning*, through clear strategic guidance, for a range of scenarios and contingencies that ROK and U.S. forces could face, focusing on the near-term, most likely and asymmetric security challenges to the

Alliance on the Korean Peninsula and recognizing the necessity for broader coordination efforts across all relevant agencies within our respective governments;

- *Further develop capabilities* to address the ballistic missile threats from North Korea through enhanced cooperation, which will contribute to combined defense capabilities;
- *Institutionalize an Extended Deterrence Policy Committee*, which is to serve as a cooperation mechanism to enhance the effectiveness of extended deterrence;
- *Enhance interoperability* between our militaries through maturing defense cooperation, including military doctrine, professional military education and training, and Command, Control, Communications, Computers, and Intelligence (C4I) systems;
- *Enhance the combined exercise programs* tailorable to both current and emerging security challenges facing the Alliance, while incorporating the United Nations Command and its Sending States, as necessary ; and
- *Collaborate on lessons learned* across the full range of operational functions, including stability and reconstruction operations, in order to build partnership capacity.

#### **IV. Regional and Global Security Challenges**

The ROK MND and the U.S. DoD recognize the importance of, and have a common interest in, closely cooperating to promote regional and global peace and stability.

Through broader regional and global contributions, the ROK MND and the U.S. DoD will also enhance and strengthen the alliance's capabilities to conduct its core mission of defending the Republic of Korea. As the ROK MND and the U.S. DoD expand our respective, cooperative security roles, we will enhance the Alliance's strategic significance and constructive contributions toward global peace and security, both now and in the future.

As allies, the ROK MND and the U.S. DoD are to undertake several measures to strengthen the Alliance's role in enhancing regional and global security, including:

- *Strengthen capabilities* to contribute to regional and global peace and stability, while ensuring a robust combined defense posture to deter aggression on the Korean Peninsula,
- *Support non-proliferation of weapons of mass destruction*, related materials and technologies, and the means of delivery through active participation in broader intergovernmental and intragovernmental efforts, including the

Proliferation Security Initiative and implementation of United Nations Security Council resolutions;

- *Enhance bilateral, trilateral, and multilateral defense relationships* to facilitate greater responsiveness and broader security cooperation with regional partners and to contribute to multilateral security efforts;
- *Strengthen cooperation* for international security and peacekeeping efforts to promote regional and global peace and stability, including close coordination on maritime security activities of mutual interest; and,
- *Cooperate closely* on other transnational and non-traditional security challenges, including through mutual efforts to combat terrorism, provide humanitarian assistance and disaster relief, and prevent cyber attacks.

## **V. Implementation**

Both the ROK MND and the U.S. DoD recognize the importance of close policy and strategic consultations in enhancing common interests and further developing the Alliance.

As the Security Consultative Meeting is charged with the responsibility of implementing the defense aspects of the Joint Vision Statement, it will continue to oversee measures by its subcommittees and the Military Committee to implement the Defense Guidelines.

The ROK Minister of National Defense and the U.S. Secretary of Defense, in close coordination with bilateral whole-of-government efforts, undertake continually to calibrate bilateral priorities to advance mutual policies and security efforts based on the Defense Guidelines.

The ROK MND and the U.S. DoD intend to revise the Defense Guidelines as changes in the security environment or other factors necessitate such revisions.

## Joint Statement of ROK-U.S. Foreign and Defense Ministers' Meeting on the Occasion of the 60<sup>th</sup> Anniversary of the Outbreak of the Korean War

July 21, 2010, Seoul

ROK Minister of Foreign Affairs and Trade Yu Myung-hwan and Minister of National Defense Kim Tae-young, and U.S. Secretary of State Hillary Rodham Clinton and Secretary of Defense Robert M. Gates met in Seoul on July 21, 2010, to commemorate the 60<sup>th</sup> anniversary of the outbreak of the Korean War, which gave birth to the ROK-U.S. Alliance.

The Ministers reflected on the shared sacrifice and dedication to defend freedom and democracy during the Korean War, and acknowledged that the ROK-U.S. Alliance has promoted peace and stability not only on the Korean Peninsula, but also in Northeast Asia, and has evolved into a strong, successful and enduring alliance.

They also noted the historic significance of the Joint Vision for the Alliance of the Republic of Korea and the United States of America adopted by the two leaders in June 2009 and pledged to continue to advance the alliance cooperation bilaterally, regionally, and globally.

The Ministers reaffirmed the mutual responsibilities and steadfast commitments of the two countries founded on the ROK-U.S. Mutual Defense Treaty, which has served as the bedrock of the allied partnership. They committed to maintain a robust combined defense posture capable of deterring and defeating any and all North Korean threats, including through recently announced bilateral plans to conduct a series of joint military exercise over the coming months in the ROK and off the east and west coasts of the Korean Peninsula. They also pledged to develop the alliance's vision for future defense cooperation.

In support of their Presidents' recent decision, the Ministers also decided to complete a new plan, Strategic Alliance 2015, by this year's Security Consultative Meeting (SCM) including the transition of wartime Operational Control (OPCON) to the ROK military in December 2015. The transition of wartime OPCON is to proceed through close coordination between the two countries to sustain and enhance the Alliance's combined defense posture and capabilities.

The Ministers welcomed the UN Security Council Presidential Statement (S/PRST/2010/13) on July 9, 2010 condemning the attack by North Korea, which led to the sinking of the Cheonan. They shared the view that such an irresponsible military provocation poses a grave threat to peace and stability not only on the Korean Peninsula but also in the region. The Ministers urged North Korea to take responsibility for the attack. They also called upon North Korea to refrain from further attacks or hostilities against the ROK and underscored there would be serious consequences for any such irresponsible behavior.

The Ministers urged North Korea to abandon all its nuclear programs and its pursuit of nuclear weapons in a complete and verifiable manner, and to demonstrate its genuine will for denuclearization with concrete actions. They also urged North



Korea to improve human rights conditions and living standards for its people in cooperation with the international community.

Building on the June 2009 Joint Vision, the Ministers reaffirmed their commitment to broaden and deepen the scope of Alliance cooperation. They shared the view that growing political, economic, social, scientific, technological, and cultural bilateral cooperation will increase the mutual understanding and respect between our citizens on the basis of common values and trust. They also committed to work together more closely and comprehensively at the regional and global levels.

Reaffirming the utmost importance of the KORUS FTA, they pledged to work towards ratification as discussed by the two Presidents in Toronto last month. They also pledged to work towards a new ROK-U.S. Agreement for Cooperation on Civil Uses of Atomic Energy in a mutually beneficial way in order to meet the challenges of climate change and energy security in the future.

Furthermore, the Ministers welcomed the close mutual cooperation on a wide range of issues within regional frameworks including the ASEAN Regional Forum (ARF) and the Asia-Pacific Economic Cooperation (APEC) and committed to work closely together to further promote peace, stability and prosperity in the region. They also discussed the Northeast Asia regional security environment and ways the Alliance can evolve to address new challenges in this dynamic region.

Meanwhile, the Ministers exchanged ideas about ways to meet the global challenges of terrorism, proliferation of weapons of mass destruction, financial crisis, transnational crimes, climate change, epidemic disease, energy security, and promotion of green growth, and decided to continue joint efforts in this regard. They also exchanged views about how development assistance can increase stability and security, and decided to increase coordination of development assistance programs around the world to help achieve our shared goals.

The Ministers shared the view that they would draw on the lessons learned through the rebuilding of the ROK in the decades following the devastating Korean War to strengthen cooperative efforts for stability and reconstruction in Afghanistan, and around the world. The U.S. side welcomed the ROK's sending of a Provincial Reconstruction Team (PRT) to Afghanistan, and the ROK side reaffirmed its determination to support security, governance, and development in Afghanistan. They also welcomed ROK-U.S. coordination and cooperation in other areas including the efforts to combat piracy near the Horn of Africa and peacekeeping efforts in Haiti.

The Ministers noted the two countries share mutual views on how to face global challenges, as evidenced by the United States previously hosting the Nuclear Security Summit and the G20 summit, and the ROK hosting these events in the future.

The Ministers concurred that today's Foreign and Defense Ministers' Meeting was very productive and useful, and decided to hold foreign and defense officials' meetings at the deputy minister/assistant secretary level. They also pledged to continue to develop the existing ministerial consultations of Strategic Consultation for Allied Partnership (SCAP) and Security Consultative Meeting (SCM) and to consider holding further Foreign and Defense Ministers' meetings, as necessary.

## Major Arms Control Conventions and Organizations

(As of November 2010)

Classification		Number of member states (the year of establishment/ effectuation)	Joined by South/ North Korea	Description
UN organizations	UN General Assembly First Committee	192 (1945)	S. Korea (September 1991) / N. Korea (September 1991)	<ul style="list-style-type: none"> <li>• One of six UN General Assembly committees for discussions concerning disarmament and international security</li> <li>• Recommends 50-60 draft resolutions per year to UN General Assembly (UNGA), mostly adopted by UNGA</li> <li>• Comprised of all UN member states</li> </ul>
	UN Disarmament Commission (UNDC)	192 (1952)	S. Korea (September 1991) / N. Korea (September 1991)	<ul style="list-style-type: none"> <li>• Carries out an in-depth review of the three major issues concerning disarmament and non-proliferation and submits a report to the upcoming UNGA</li> <li>• A body that deliberates on the directions and principles concerning major issues being discussed by the international community</li> <li>• Comprised of all UN member states</li> </ul>
	Conference on Disarmament (CD)	65 (March 1960)	S. Korea (June 1996) / N. Korea (June 1996)	<ul style="list-style-type: none"> <li>• Only multi-national disarmament negotiation body in the world</li> <li>• Most major disarmament-related multi-national treaties are made through this body.</li> <li>• The UNGA does not directly control this body, but it is regularly funded by the UN. CD fixes its own agenda and proceeding rules.</li> <li>• CD submits an annual report to the UNGA.</li> </ul>
Nuclear weapons	Nuclear Non-Proliferation Treaty (NPT)	190 (March 1970)	S. Korea (April 1975) / N. Korea (December 1985)	<ul style="list-style-type: none"> <li>• Prevents the spread of nuclear weapons and to promote peaceful use of nuclear power</li> </ul>
	International Atomic Energy Agency (IAEA)	151 (July 1957)	S. Korea (August 1957) / N. Korea (June 1974, but *withdrew in June 1994)	<ul style="list-style-type: none"> <li>• Carries out international cooperation initiatives to promote the peaceful use of atomic energy and prevent its transfer for military purposes</li> </ul>
	Comprehensive Nuclear Test Ban Treaty (CTBT)	182 (Not effectuated yet)	S. Korea (September 1999)	<ul style="list-style-type: none"> <li>• Bans all nuclear tests in all environments- under the ground, in the water, in the air and space</li> </ul>

Classification		Number of member states (the year of establishment/ effectuation)	Joined by South/ North Korea	Description
Missiles	Hague Code of Conduct against Ballistic Missile Proliferation (HCOC)	130 (November 2002)	S. Korea (November 2002)	A body encouraging voluntary control of ballistic missiles under the recognition that MTCR alone cannot sufficiently prevent their spread *Bans support for missile development programs in states feared to be developing or procuring WMDs
Biological/ chemical weapons	Biological Weapons Convention	163 (March 1975)	S. Korea (June 1987) / N. Korea (March 1987)	• Completely bans development, production and stockpiling of biological weapons, agents and toxins
	Chemical Weapons Convention (CWC)	188 (April 1997)	S. Korea (April 1997)	• Completely bans the development, production, stockpiling and use of chemical weapons • Stipulates that all member states should scrap all chemical weapons in their possession within 10 years of joining the Convention. *The said deadline may be extended for up to five years when unavoidable. [All member states should scrap all of their chemical weapons by April 2012.]
	Organization for the Prohibition of Chemical Weapons (OPCW)	188 (May 1997)	S. Korea (April 1997)	• An executive organization verifying and inspecting to see whether member states have implemented their CWC obligations
Conventional weapons	Convention on Certain Conventional Weapons (CCW)	108 (December 1983)	S. Korea Protocols I & II (May 2001) Protocol III (January 2008)	• Convention to prohibit or restrict use of certain conventional weapons which cause excessive injury or indiscriminate results -CCW Protocol I prohibits use of any weapon, the primary effect of which is to inflict injury with fragments that escape x-ray detection. -CCW Protocol II prohibits or restricts use of mines, booby-traps and other devices. -CCW Protocol III prohibits or restricts use of incendiary weapons. -CCW Protocol IV prohibits use of blinding laser weapons. -CCW Protocol V regulates explosive remnants of war.
	UN Register of Conventional Arms (UNRCA)	173 (December 1991)	S. Korea (1993)	• Stipulates that all member states annually submit registered data on their imports and exports of conventional arms with available background information • Aims to promote enhanced levels of transparency in armaments, thereby contributing to confidence-building measures

Classification		Number of member states (the year of establishment/ effectuation)	Joined by South/ North Korea	Description
Multilateral export control system	Zangger Committee (ZC)	36 (August 1974)	S.Korea (October 1995)	<ul style="list-style-type: none"> <li>• A nuclear export control regime that ensures implementation of Article 3, Paragraph 2 of the NPT, which prohibits export of nuclear material or equipment to any non-nuclear powers that have failed to comply with relevant safety measures</li> <li>• Only NPT member states may join the Committee</li> </ul>
	Nuclear Suppliers Group (NSG)	45 (January 1978)	S.Korea (October 1995)	<ul style="list-style-type: none"> <li>• An export control regime concerning nuclear materials, equipment, and technology</li> <li>• Non-NPT member states may join Group</li> <li>• Control of export on all non-nuclear powers regardless of their NPT membership</li> <li>• Controls export of nuclear power-related "dual-use" equipment and technology</li> </ul>
	Australia Group (AG)	41 (June 1985)	S.Korea (October 1996)	<ul style="list-style-type: none"> <li>• Carries out activities that prevent the spread of chemical and biological weapons-related materials and technology to countries feared to possess biological and chemical weapons</li> </ul>
	Missile Technology Control Regime (MTCR)	34 (April 1987)	S.Korea (March 2001)	<ul style="list-style-type: none"> <li>• A voluntary international regime that prevents the proliferation of rockets that carry WMDs, unmanned aerial vehicles; the export of relevant equipment; and technology transfer</li> </ul>
	Wassenaar Arrangement (WA)	40 (April 1996)	S.Korea (April 1996)	<ul style="list-style-type: none"> <li>• An export control regime concerned with conventional weapons and dual-use equipment and technology</li> </ul>
Prevention of WMD proliferation	Proliferation Security Initiative (PSI)	95 (June 2003)	S.Korea (May 2009)	<ul style="list-style-type: none"> <li>• A global effort that aims to block illegal trade of WMDs, missiles and , related materials by rogue states and terrorist groups</li> </ul>

# National Defense Organizations

## National Defense Organizations

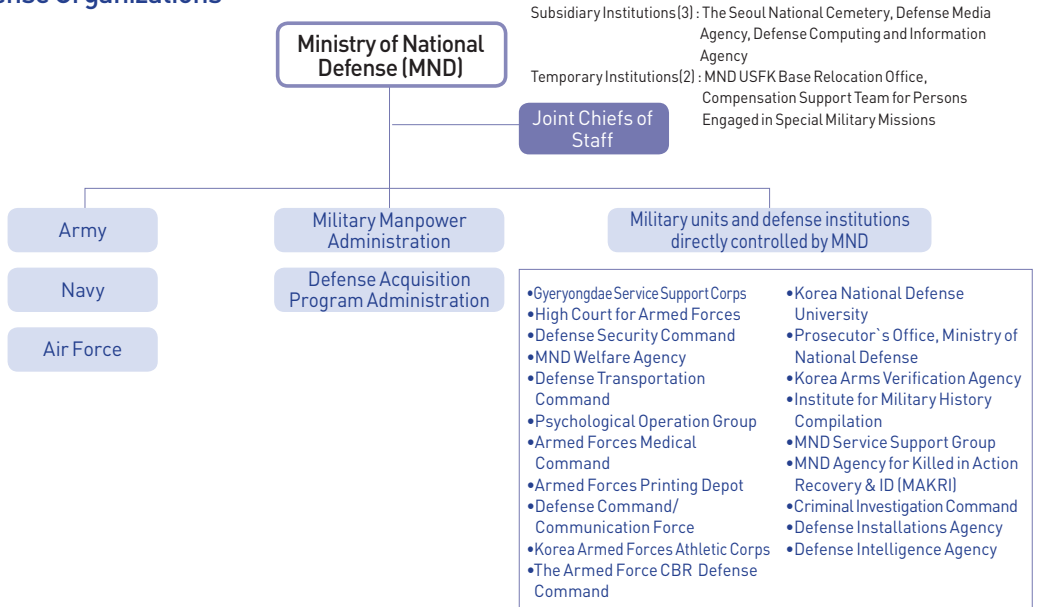

## MND Headquarters

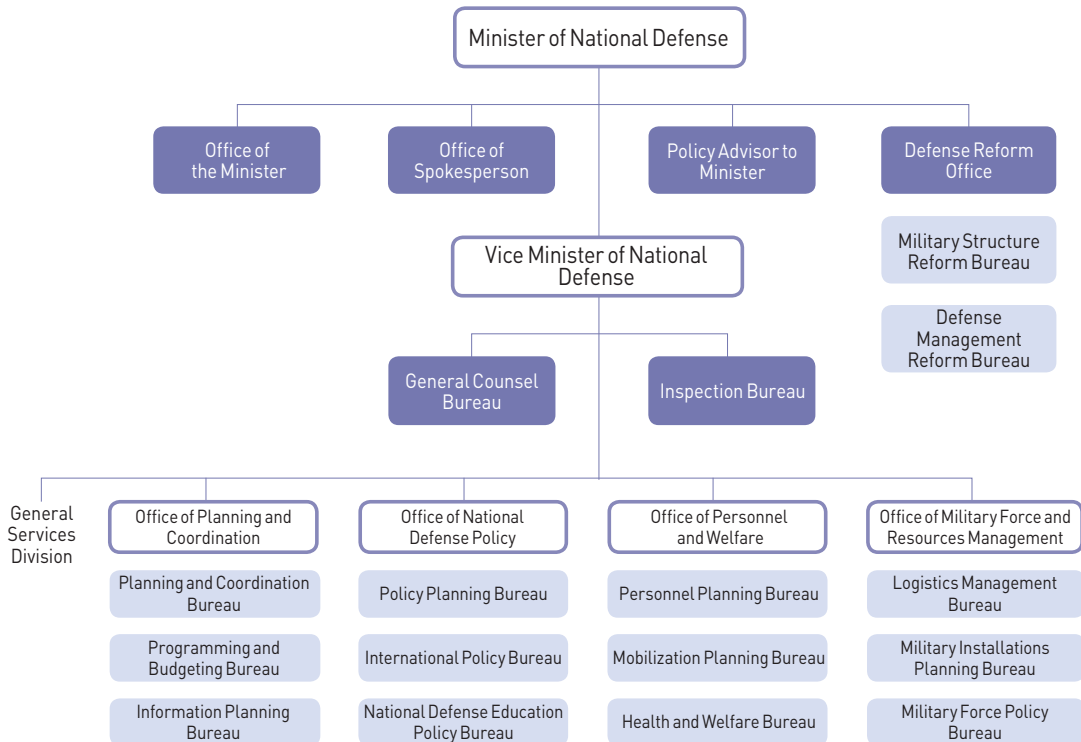

## Assignments and functions of MND subsidiary institutions, including non-permanent groups

Organization		Assignments and functions
Subsidiary institutions	Seoul National Cemetery	<ul style="list-style-type: none"> <li>• Management and operation of the cemetery, facilities and surrounding forest</li> <li>• Planning and executing memorial rituals</li> <li>• Giving tours to visitors and managing specially designated boundaries for graves</li> <li>• Planning and executing educational initiatives about those who sacrificed their lives for their homeland</li> <li>• Publicizing its activities</li> </ul>
	Defense Media Agency	<ul style="list-style-type: none"> <li>• PR for the military and education of service members through Korea Defense Daily, Armed Forces Broadcast, TV and radio</li> <li>• Selection and operation of Armed Forces PR Support Team</li> <li>• Production of defense news and cyber-based PR activities</li> <li>• Photograph and records management related to defense-related events</li> </ul>
	Defense Computing and Information Agency	<ul style="list-style-type: none"> <li>• Development, operation and maintenance of Defense Resources Management Information System</li> <li>• Procurement and operation of communications network and computer equipment for MND and its subsidiary institutions</li> <li>• Research, spread and management of new information technology</li> <li>• Planning and executing information educational programs</li> </ul>
Temporary institutions	MND USFK Base Relocation Office (MURO)	<ul style="list-style-type: none"> <li>• Planning and execution of USFK facility-related projects</li> <li>• Execution, management and supervision of USFK facility-related projects</li> <li>• Provision of support for management and operation of Special Accounts for Relocating USFK Bases</li> <li>• Other matters concerning promotion of USFK facility-related projects</li> </ul>
	Compensation Support Team for Persons Engaged in Special Military Missions	<ul style="list-style-type: none"> <li>• Preparations and assistance for deliberations of Special Military Mission Performers Compensation Deliberation Committee and its sub-committees</li> <li>• Budget compilation and execution of compensatory payments</li> <li>• Checking applicants' submitted materials for compensation payments</li> <li>• Handling of lawsuit and responding to civil grievance concerning compensation</li> </ul>

## Assignments and functions of public institutions

		Assignments and functions
Public institutions	Korea Institute for Defense Analyses (KIDA)	<ul style="list-style-type: none"> <li>• Research on security environment and basic defense policies</li> <li>• Research on military strategies and buildup/evaluation of military strength</li> <li>• Research on defense human resources, personnel affairs, welfare and mobilization</li> <li>• Provision of survey statistics, information and consulting related to defense issues</li> </ul>
	The War Memorial of Korea	<ul style="list-style-type: none"> <li>• Construction and operation of war memorials and monuments</li> <li>• Collection, preservation, management, exhibition, surveys and research concerning military war relics</li> <li>• Research on war history, search for patriot-related stories and other academic research activities</li> <li>• PR for commemorative projects and educational programs and distribution of relevant publications</li> </ul>
	Ho-Guk Foundation	<ul style="list-style-type: none"> <li>• Payment of undergraduate tuition fees for children of MND military and civilian personnel</li> <li>• Special consideration provided to children of service members applying for college admission</li> <li>• Provision of administrative services for loans from military personnel welfare fund</li> </ul>

## Annual Defense Budgets

	Defense budget (unit: billion won)	Defense budget-GDP ratio (%)	Defense budget-government expenditure ratio(%)	Rate of increase of the defense budget (%)
1981	2,697.9	5.54	33.6	20.1
1982	3,120.7	5.60	33.5	15.7
1983	3,274.1	4.99	31.4	4.9
1984	3,306.1	4.40	29.6	1.0
1985	3,689.2	4.39	29.4	11.6
1986	4,158.0	4.24	30.1	12.7
1987	4,745.4	4.12	29.6	14.1
1988	5,520.2	4.03	30.0	16.3
1989	6,014.8	3.89	27.3	9.0
1990	6,637.8	3.56	24.2	10.4
1991	7,476.4	3.31	23.8	12.6
1992	8,410.0	3.27	25.1	12.5
1993	9,215.4	3.17	24.2	9.6
1994	10,075.3	2.96	23.3	9.3
1995	11,074.3	2.78	21.4	9.9
1996	12,243.4	2.73	20.8	10.6
1997	13,786.5	2.81	20.7	12.6
1998	13,800.0	2.85	18.3	0.1
1999	13,749.0	2.60	16.4	-0.4
2000	14,477.4	2.50	16.3	5.3
2001	15,388.4	2.47	15.5	6.3
2002	16,364.0	2.39	14.9	6.3
2003	17,514.8	2.42	14.8	7.0
2004	18,941.2	2.43	15.8	8.1
2005	21,102.6	2.60	15.6	11.4
2006	22,512.9	2.66	15.3	6.7
2007	24,497.2	2.72	15.5	8.8
2008	26,649.0	2.76	15.2	8.8
2009	28,532.6	2.79	14.5	7.1
2010	29,562.7	2.62	14.7	3.6

## Defense Industrial Cooperation Agreements with Other Countries

Number of countries with which ROK has signed defense industrial cooperation agreements (or MOUs): 30

Country	Signed in	Country	Signed in	Country	Signed in	Country	Signed in
Malaysia	1981.6.	Israel	1995. 8.	Turkey	1999.11.	South Africa	2007.8.
U.S.	1988.6.	Indonesia	1995. 10.	Venezuela	1999.12.	Columbia	2008.5.
Thailand	1991.4.	Canada	1996. 5.	Australia	2001.8.	Ecuador	2009.1.
France	1992.3.	Germany	1997. 11.	Vietnam	2001.8.	Egypt	2009.12.
Spain	1992.3.	Russia	1997. 11.	Bangladesh	2004.1.	Uzbekistan	2010.2.
U.K.	1993.9.	Rumania	1997. 11.	India	2005.9.	Peru	2010.5.
Italy	1993.9	New Zealand	1998. 11	Pakistan	2006.5.		
Philippines	1994.5	Netherlands	1999.6	Ukraine	2007.8		

### Other defense industrial cooperation agreements (as of November 2010)

Agreements for technological cooperation (9 countries)	Agreements for quality guarantees (18 countries)	Agreements for provision of price information (4 countries)
U.S., France, UK, Italy, Israel, Russia, Turkey, Norway, Sweden	U.S., UK, France, Spain, Switzerland, Canada, Italy, Netherlands, Belgium, Denmark, Australia, Philippines, Germany, Israel, Turkey, Indonesia, New Zealand, Greece	U.S., UK, Germany, Netherlands



## Changes in Compulsory Military Service Period

Year	Compulsory military service period (unit: Months)			Reason for adjustment
	Army/Marine Corps	Navy	Air Force	
pre-1952	No discharging from active service			Inability to execute Military Service Act normally due to Korean War
1953	36	36	36	Those who perform service on long-term basis during the Korean War are discharged following Armistice Agreement.
1959	33	36	36	Alleviate the burden of compulsory service of Army
1962	30	36	36	Alleviate the burden of compulsory service of Army
1968	36	39	39	Service period is extended following attempted attack on Cheongwadae (presidential residence) by North Korean armed guerrillas on 21 January, 1968.
1977	33	39	39	Amid surplus military personnel resources, shorten the service period of Army to support those with special industrial skills in businesses as an alternative to compulsory military service.
1979	33	35	35	Shorten the service period of Navy and Air Force to make recruiting easier.
1984	30	35	35	Alleviate the burden of compulsory service of Army.
1990	30	32	35	Shorten the service period of Navy to make recruiting easier.
1993	26	30	30	Shorten the service period to solve surplus of military personnel resources
1994	26	28	30	Shorten the service period of Navy to make recruiting easier.
2003	24	26	28	Alleviate the burden of compulsory military service of Army, Navy and Air Force
2004	24	26	27	Shorten the service period of Air Force to make recruiting easier.
2008	24 → 18	26 → 20	27 → 21	Reduce troop numbers and shorten service period to settle the problem of surplus military service resources. * Gradual reduction of service period for those enlisted during January 2006 ~ July 2014.

\* The 'military service period' refers to the period fixed under the Military Service Act.

## Alternatives to Military Service

Alternatives		Service period	Qualifications	Selection authority	Service sectors	Workplace	Legal basis
Public service personnel	Administrative support personnel	22-26 months*	Replacement resource	MMA Administrator	Support for social welfare facilities; health; patient transportation; support for education of disabled children; environmental monitoring; etc.	Government institutions; local administrative units; public organizations; social welfare facilities	Military Service Act
					Administrative support		
	Arts and athletics personnel	34 months	Silver medal or higher at international sports competition	Minister of Culture, Sports and Tourism	Arts	Minister of Culture, Sports and Tourism	Military Service Act
			Bronze medal or higher at Olympics; Gold medal at Asian Games		Athletics		
International cooperation personnel		30 months	Recommended by Foreign Affairs and Trade Minister and selected by Military Affairs Deliberation Committee	Foreign Affairs and Trade Minister	International cooperation	MOFAT	Act on International Cooperation Personnel
Skilled industry personnel	Active-duty personnel	34 months	Technician license holders	Head of military service-related designated business	Businesses in manufacturing, mining, energy, construction, fisheries, ocean transportation, agriculture, and defense industry	Designated business and defense industry businesses	Military Service Act
			Bronze medal or higher at World Skills Competition	Employment and Labor Minister			
	Those inheriting agricultural assets or fisheries	City or county mayor					
Replacement personnel		26 months	No restrictions on academic background or skills qualifications	Head of military service-related designated business			

\* As for public service personnel, their service period has been reduced gradually from 26 months to 22 months, from 2008 onwards.

Alternatives		Service period	Qualifications	Selection authority	Service sectors	Workplace	Legal basis
Specialized research personnel	Active-duty personnel	36 months	Those holding master's degree or higher working at research institute designated as military service institute and recommended by relevant authorities	Education, Science and Technology Minister	Academic/ technological research	Research institutions in natural science sector	Military Service Act
	Replacement personnel			Head of relevant central governmental institution		Research institutions in humanities and social science sectors	
				ADD President		Defense industry research institutions	
				Education, Science and Technology Minister		University research institutions	
Public health doctors		36 months	Medical doctors, dentists, herbal doctors	Health and Welfare Minister	Medical services in rural areas	Ministry of Health and Welfare	Act on Special Measures for Public Health Services in Rural Areas
Medical doctors for military conscription			Medical doctors, dentists	MMA Administrator	MMA's military draft physical examination	MMA	Military Service Act
Medical doctors for international cooperation			Medical doctors, dentists, herbal doctors	Foreign Affairs and Trade Minister	Medical services in developing countries	MOFAT	Act on International Cooperation Personnel
Public service Advocates			Attorneys-at-law	Justice Minister	Korea Legal Aid Corporation	Ministry of Justice	Public-Service Advocates Act
Public service veterinarian			Veterinarians	Health and Welfare Minister	Cattle quarantine	Ministry of Food, Agriculture, Forestry and Fisheries	Public-Service Veterinarians Act

## Combined/Joint Military Exercises and Training

### ROK-U.S. combined exercises

Name	Type	Purpose	Description
Ulchi Freedom Guardian (UFG)	Military command post and government exercises	<ul style="list-style-type: none"> <li>•Developing ROK Joint Chiefs of Staff and U.S. KORCOM's theater operations commanding and executing abilities in preparation for transition of wartime OPCON</li> <li>•Becoming proficient with conducting procedure of Chungmu Plan and warfighting SOP</li> </ul>	<ul style="list-style-type: none"> <li>•Crisis management exercise</li> <li>•Wartime transition procedure exercise</li> <li>•OPLAN-conducting procedure exercise</li> <li>•Senior Leaders seminar</li> <li>•Military Coordination Elements operating exercise</li> </ul>
Key Resolve/ Foal Eagle (KR/FE) Exercise	Command post exercises/ Field training exercises	<ul style="list-style-type: none"> <li>•Exercise theater operations commanding and conducting procedure under current combined defense system</li> <li>•Guaranteeing deployment of U.S. augmentation forces on Korean Peninsula and maintaining ROK Armed Forces' warfighting sustainability</li> </ul>	<ul style="list-style-type: none"> <li>•Crisis management exercise</li> <li>•Wartime transition exercise</li> <li>•OPLAN-conducting procedure exercise</li> <li>•Becoming proficient with Reception, Staging, Onward movement, and Integration procedure within combined operational areas</li> <li>•Senior Leaders seminar</li> </ul>

### ROK forces' joint exercise and training

Name	Type	Purpose	Description
Taegeuk Exercise	Theater-level command post exercises	Possessing theater operations conducting capability of Joint Chiefs of Staff	<ul style="list-style-type: none"> <li>•Joint Chiefs of Staff exercises crisis management, transition to war, and operations conducting procedure</li> <li>•Exercise joint mission essential task and relevant staff offices' supporting tasks</li> <li>•Operating ROK-U.S. Military Coordination Elements</li> </ul>
Hoguk Exercise	Large scale unit (theater and operational command level) Joint Exercise	Enhancing jointness-centered operational conducting capability	<ul style="list-style-type: none"> <li>•Synchronized and integrated exercise of all Services under theater operational plan</li> <li>•Become proficient with key exercise tasks requiring jointness at each operational command level</li> <li>•Verifying joint operations system</li> </ul>
Hwarang Exercise	Comprehensive Rear Area Exercises	Enhancing operational conducting capability within rear areas during wartime/ peacetime	<ul style="list-style-type: none"> <li>•Become proficient with wartime/peacetime operational plans conducting procedure</li> <li>•Inspiring local residents with security consciousness</li> <li>•Verify civilians, government, military and police integrated defense posture</li> </ul>

## Combined exercises





Name	Frequency	Participating countries	Descriptions
Combined anti-terrorism exercise	Once a year	South Korea, U.S., and Russia	<ul style="list-style-type: none"> <li>• Repel/climbing exercise</li> <li>• Anti-terrorism commando firing</li> <li>• Inside clearing exercises (buildings, trains, airplanes, etc)</li> <li>• Privately-made explosives disposal</li> <li>• Comprehensive mock exercises</li> </ul>
Khann Quest	Once a year	South Korea, UK, Germany, Japan, and China etc.	<ul style="list-style-type: none"> <li>• Field tactical exercise</li> <li>• Command post exercise</li> <li>• Medical support exercise</li> </ul>
Rim of the Pacific Exercise (RIMPAC)	Biennially (June-August in even-numbered years)	South Korea, U.S., Australia, Chile, UK, Japan, Canada, and Peru etc.	<ul style="list-style-type: none"> <li>• Offensive/defensive sea battle</li> <li>• Protecting sea routes</li> <li>• Maritime interdiction and air assault</li> <li>• Naval firing exercise</li> <li>• Guided missile and torpedo launching exercise</li> </ul>
Pacific Reach	Triennially	South Korea, U.S., Australia, Japan, and Singapore etc.	<ul style="list-style-type: none"> <li>• Submarine crew escaping/ rescuing exercises</li> </ul>
Western Pacific Mine Countermeasures Exercise (MCMEX)	Biennially (on even-numbered years)	South Korea, Japan, Australia, Singapore, Indonesia, Malaysia, and Thailand etc.	<ul style="list-style-type: none"> <li>• Anti-mine warfare exercise (mine search/clearing)</li> <li>• EOD (explosive ordnance disposal) exercise</li> <li>• Medical exercise</li> </ul>
ROK-US ASW Exercise(GUAMEX)	Biennially (on odd-numbered years)	South Korea and U.S.	<ul style="list-style-type: none"> <li>• Submarine battle exercises</li> <li>• CSOF/SLOC protection exercise</li> <li>• Offensive mine-laying</li> </ul>
Cobra Gold Exercise	Once a year	South Korea, U.S., and Thailand	<ul style="list-style-type: none"> <li>• Combined amphibious operations</li> <li>• Command post exercise</li> <li>• Tactical maneuvering exercise</li> <li>• Stabilization operations</li> <li>• Airlifting on the sea</li> </ul>
Combined Amphibious Operations Exercise	Once a year along with FE (Foal Eagle)	South Korea and U.S.	<ul style="list-style-type: none"> <li>• Loaded/advanced troops operations</li> <li>• Three-dimensional amphibious attack</li> <li>• On the sea maneuvering and fire supporting exercise</li> <li>• Land operations (securing and defending a beachhead )</li> <li>• Integrated fire power operations</li> </ul>
ROK-Japan Search and Rescue Exercise	Biennially (on odd-numbered years )	South Korea and Japan	<ul style="list-style-type: none"> <li>• Basic tactical exercises</li> <li>• Searching-and-rescuing exercise for airplanes/ships in distress</li> </ul>
Combined Large Force Employment (CLFE) exercise	Six times a year	South Korea and U.S.	<ul style="list-style-type: none"> <li>• Offense formation mid-altitude infiltration and intercept exercises</li> <li>• Enhancement of survival capability and operational performance during infiltrations</li> <li>• Become proficient with peacetime strike procedures, selecting virtual targets</li> </ul>
Cooperative Cope Thunder (RED FLAG-Alaska)	Biennially	South Korea, Japan, Singapore, Thailand, Australia, UK, and France etc.	<ul style="list-style-type: none"> <li>• Low-altitude infiltration and cargo dropping exercise</li> <li>• Tactical aerial raid exercise using an unpaved runway</li> <li>• Air infiltration exercise for pilots and crew members</li> </ul>
Max Thunder	Twice a year	South Korea and U.S.	<ul style="list-style-type: none"> <li>• Mid-altitude infiltration and intercept exercise by striking package forces</li> <li>• Become proficient with realistic warfare attack procedures, selecting virtual targets</li> </ul>

# Composition and Major Activities of National Assembly Defense Committee

## Defense Committee members

Specialist	Senior Specialist	Chairman			Legislative researchers
		Name	Academic background and experience	Office/contact number	
Gu Byeong-hoe (Grade-2)	Gwon Gi-yul (Grade-1)	 Won Yoo Chul	-Pyeongtaek-A, Gyeonggido; 3 <sup>rd</sup> term -Born in 1962 -Korea University, Department of Political Science and International Relations; Visiting researcher at Stanford University -GNP, Gyeonggi-do Chapter; member of Public Administration and Security Committee; Chairman of NA Special Committee on Safeguarding Dokdo	Headquarters Room 421 Phone: 784-1364 788-2721 Fax: 788-3685 *From overseas, dial +822	Lee Jeong-deuk (Grade-3) Gye Jun-ho (Grade-3) Jo Mun-sang (Grade-4) Gong Chun-taek (Grade-4) Jeong Gyeong-yun (Grade-4)

Name	Academic background and experience	Office/contact number	Name	Academic background and experience	Office/contact number		
Grand National Party (GNP)	 Kim Dong Sung	- Seongdong-gu-B, Seoul; 1 <sup>st</sup> term -Born in 1971 -Seoul National University, College of Law; Yonsei University, Business School; legal counsel for City of Seoul; Head of GNP, Seongdong-B Chapter; Secretary of NA Defense Committee (currently)	The Members' Hall: Room 217 Phone: 784-3873 788-2491 Fax: 788-3217	 Shin Hak Yong	-Geyang-A, Incheon; 2 <sup>nd</sup> term -Born in 1952 -Seoul National University, Department of Politics; Passed State Examination for Court Administration; Secretary for NA Political Affairs; Chairman of Korean Business Table Tennis Federation (KBTF); Chairman of NA Fiscal Policy Research Association; Secretary for NA Defense Committee (currently)	The Members' Hall: Room 810 Phone: 784-6086 788-2165 Fax: 788-3810	
	 Kim Ok Lee	-Elected based on proportional representation; 1 <sup>st</sup> term -Born in 1947 -Dong-A University, Department of Public Administration -Chief of the 15 <sup>th</sup> Women's Army Corps; member of Gyeonggi-do Council; Chair of Women's Army Corps Veterans' Association	The Members' Hall: Room 304 Phone: 784-5287 788-2874 Fax: 788-3304	Democratic Party	 Park Sang Cheon	-Goheung-gun/Boseong-gun, Cheonnam-do; 5 <sup>th</sup> term -Born in 1938 -Seoul National University, Department of Law; Passed State Bar Examination; Spokesperson for Democratic Party; Representative for Democratic Party of Political Reform Negotiation; Justice Minister; Chairman of NA Health & Welfare Committee; member of NA Foreign/Unification/Trade Committee	The Members' Hall: Room 721 Phone: 784-5075 788-2709 Fax: 788-3721
	 Kim Jang Soo	-Elected based on proportional representation; 1 <sup>st</sup> term -Born in 1948 -Korea Military Academy (class 27); Commanding General of 6 <sup>th</sup> Division and 7 <sup>th</sup> Corps; Director of Operations of Joint Chiefs of Staff (JCS); Deputy Commander-in-Chief, ROK-U.S. Combined Forces Command; Army Chief of Staff; Defense Minister	The Members' Hall: Room 534 Phone: 784-5277 788-2835 Fax: 788-3534		 Seo Jong Pyo	-Elected based on proportional representation; 1 <sup>st</sup> term -Born in 1945 -Korea Military Academy (class 25); Commanding General of 25 <sup>th</sup> Division, 6 <sup>th</sup> Corps, and 3 <sup>rd</sup> Army; Inspector General at Army Headquarters; President of National Defense University; Vice President, Hanbuk University	The Members' Hall: Room 743 Phone: 784-2972 788-2421 Fax: 788-3743

Name	Academic background and experience	Office/contact number	Name	Academic background and experience	Office/contact number		
Grand National Party (GNP)	 Kim Hak Song	-Jinhae-gu, Changwon-si, Gyeongnam-do; 3 <sup>rd</sup> term -Born in 1952 -Konkuk University, Department of Politics -Member of Gyeongnam-do Council; Secretary for Special Committee on Budget and Accounts; GNP deputy whip; GNP Deputy Secretary General; Head of GNP Gyeongnam-do Chapter; Chairman of NA Defense Committee	The Members' Hall: Room 531 Phone: 784-3852 788-2385 Fax: 788-3531	 Ahn Gyu Baek	-Elected based on proportional representation; 1 <sup>st</sup> term -Born in 1961 -Sungkyunkwan University, Graduate School of Foreign Trade; Chairman of Democratic Party Organizing Committee; Head of 17 <sup>th</sup> Election Headquarters; Chairman of Democratic Party 2 <sup>nd</sup> Policy Coordination Committee (currently)	The Members' Hall: Room 705 Phone: 784-4181 788-2601 Fax: 788-3705	
	 Yoo Seong Min	-Dong-gu-B, Daegu; 2 <sup>nd</sup> term -Born in 1958 - Seoul National University, Department of Economics; Wisconsin University; Director, Yeouido Institute; Advisor to Fair Trade Commission; Professor at Hallym University; Chairman of GNP 3 <sup>rd</sup> Policy Coordination Committee	The Members' Hall: Room 434 Phone: 784-5705 788-2919 Fax: 788-3434	Democratic Party	 Chung Sye Kyun	-Jinan-gun/Muju-gun/Jangsu-gun/ Imsil-gun, Jeonbuk-do; 4 <sup>th</sup> term - Born in 1950 -Korea University, Department of Law; Ph.D. in Business Administration from Kyunghee University; Chairman of Student Association at Korea University; Floor leader of Uri Party; Industrial Minister; member of NA Foreign/ Unification/Trade Committee; Representative of Democratic Party	The Members' Hall: Room 610 Phone: 784-5716 788-2895 Fax: 788-3610
	 Chung Mi Kyung	-Gwonseon-gu, Suwon-si; 1 <sup>st</sup> term -Born in 1965 - Korea University, Department of Law; Passed 38 <sup>th</sup> Judicial Examination; Prosecutor in Euijeongbu, Bucheon and Suwon; member of NA Health and Welfare Committee; Legal advisor to Minister of Gender Equality	The Members' Hall: Room 201 Phone: 784-3880 788-2514 Fax: 788-3201		Liberty Forward Party (LFP)	 Lee Jin Sam	-Buyeo-gun/Cheongyang-gun, Chungnam-do; 1 <sup>st</sup> term -Born in 1937 -Korea Military Academy (class 15); Commanding General of 9 <sup>th</sup> Airborne Special Forces Brigade, 21 <sup>st</sup> Division, 3 <sup>rd</sup> Corps, and 1 <sup>st</sup> Army; Army Chief of Staff; Minister of Youth and Sports
	 Chung Ui Hwa	-Jung-gu/Dong-gu, Busan; 4 <sup>th</sup> term -Born in 1948 -Master's degree from Yonsei University, Medical College; Ph.D. degree from Inje University, Medical College; Neurosurgery specialist; NKP deputy spokesperson; GNP deputy whip; Chair of NA Science & Technology Committee; member NA Foreign/Unification/ Trade Committee; Vice Speaker (currently)	The Assembly Hall: Room 306 Phone: 784-2051 788-2216 Fax: 788-3306	Future Hope Alliance (FHA)	 Song Young Sun	-Elected based on proportional representation; 2 <sup>nd</sup> term -Born in 1953 -Ph.D. in international politics from Hawaii University; Senior researcher at KIDA; Director at Korean Institute for Women & Politics; Director of Center for Security and Strategy, KIDA; member of NA Foreign/Unification/ Trade Committee	The Members' Hall: Room 741 Phone: 784-5272 788-2816 Fax: 788-3741
	 Han Ki Ho	-Cheorwon-gun/Hwacheon-gun/ Yanggu-gun/Inje-gun, Gangwon-do; 1 <sup>st</sup> term -Born in 1952 - Korea Military Academy (class 31); Commanding General of 2 <sup>nd</sup> Infantry Division; Chief of Information Operations at Army Headquarters; Commanding General of 5 <sup>th</sup> Corps; Commander, Army Training Doctrine Command; Advisor to GNP Special Committee on Countermeasures concerning Cheonan Incident	The Members' Hall: Room 337 Phone: 784-2174 788-2252 Fax: 788-3337	People First Union (PFU)	 Sim Dae Pyung	-Gongju-si/Yeonggi-gun, Chungnam-do; 2 <sup>nd</sup> term -Born in 1941 -Seoul National University, Department of Economics; Senior Secretary to the President on Administrative Affairs; Chungnam-do Governor; Representative of the PFU (currently)	The Members' Hall: Room 842 Phone: 784-2070 788-2980 Fax: 788-3842

## Major activities of National Assembly Defense Committee (January 2009–November 2010)

Classification	Date	Activities
280 <sup>th</sup> extraordinary session of National Assembly (January 9, 2009–January 31, 2009)	January 12, 2009	•Receives report on pending issues, including construction of the second Lotte World theme park
281 <sup>st</sup> extraordinary session of National Assembly (February 2, 2009–March 3, 2009)	February 3	•Public hearing on construction of second Lotte World theme park
	February 19	•Receives MND's business report. Passes Motion for Dispatch of ROK Troops to the Sea off Somalia
	February 24	•Passes seven amendments of relevant laws, including partial amendments of the Defense Acquisition Act
282 <sup>nd</sup> extraordinary session of National Assembly (April 1, 2009–April 30, 2009)	April 1	•Receives report on pending issues concerning North Korea's test-firing of missiles
	April 5	•Passes Resolution Denouncing North's Test-firing of Long-range Rockets
	April 14	•Receives report on pending issues concerning new city Songpa
	April 17	•Passes first supplementary budget for 2009
	April 30	•Receives report on revised version of Defense Reform Basic Plan
282 <sup>nd</sup> extraordinary session of National Assembly (while Assembly was out of session)	May 25	•Receives report concerning NK's nuclear test •Passes resolution denouncing North's nuclear test, 'a provocative act.'
283 <sup>rd</sup> extraordinary session of National Assembly (June 26, 2009–July 25, 2009)	June 30	•Receives MND's report on pending issues, including defense-related content discussed at ROK-U.S. Summit
	July 9	•Receives MND's report on cyber terrorism
284 <sup>th</sup> regular session of National Assembly (September 1, 2009–December 9, 2009)	September 18	•Holds confirmation hearing for Defense Minister-designate Kim Tae-young
	September 24	•Holds confirmation hearing for Chairman of Joint Chief of Staff-designate Lee Sang-eui
	September 25	•Passes revenue/expenditure accounts settlement for 2008
	October 5–October 24	•Oversees functioning of 53 Governmental institutions, including MND and Joint Chiefs of Staff
	October 29	•Receives report on South Korean civilian defecting to North and plan for dispatch of ROK troops to Afghanistan
	November 10	•Receives report on South's action against provocative act perpetrated by patrol boat from North
	November 16	•Receives MND's report on pending issues, including defense budget for 2010
	November 23	•Passes Motion to Extend dispatch of ROK troops in the sea off Somalia •Passes bill for 2010 budget and fund operation plan
	November 27	•Passes 15 bills, including partial amendment to Armed Forces Organization Act •Receives report on pending issues concerning K2 Black Panther tank
	December 4	•Holds public hearing for partial amendment to Military Service Act



Classification	Date	Activities
287 <sup>th</sup> extraordinary session of National Assembly (February 2, 2010-March 2, 2010)	February 18, 2010	<ul style="list-style-type: none"> <li>• Discusses 12 items, including partial amendment of Military Personnel Management Act, and refers them to Subcommittee for bill deliberation</li> </ul>
	February 19	<ul style="list-style-type: none"> <li>• Receives report on status of business from MND, Defense Acquisition Program Administration (DAPA), and Military Manpower Administration (MMA)</li> <li>• Consents to dispatch the ROK military unit to Afghanistan</li> </ul>
	February 24	<ul style="list-style-type: none"> <li>• Passes six items, including partial amendment of Defense Acquisition Program Act</li> <li>• Holds public hearing on bill concerning areas adjacent to military installations</li> </ul>
288 <sup>th</sup> extraordinary session of National Assembly (March 3, 2010-March 31, 2010)	March 27	<ul style="list-style-type: none"> <li>• Receives report on sinking of a naval vessel</li> </ul>
	March 29	<ul style="list-style-type: none"> <li>• Receives additional report on sinking of a naval vessel</li> </ul>
289 <sup>th</sup> extraordinary session of National Assembly (April 1, 2010-April 30, 2010)	April 14	<ul style="list-style-type: none"> <li>• Receives MND's report on pending issue (i.e., attack on ROKS Cheonan)</li> </ul>
	April 19	<ul style="list-style-type: none"> <li>• Discusses 20 bills, including partial amendment of Military Personnel Management Act, and refers them to Subcommittee for bill deliberation</li> <li>• Receives the MND's report on a pending issue (i.e., attack on ROKS Cheonan)</li> </ul>
	April 30	<ul style="list-style-type: none"> <li>• Receives MND's report on pending issue (i.e., attack on ROKS Cheonan)</li> <li>• Receives report on crash of an F-5 fighter and a 500MD helicopter</li> </ul>
291 <sup>st</sup> extraordinary session of National Assembly (June 1, 2010-June 30, 2010)	June 21	<ul style="list-style-type: none"> <li>• Receives MND's report on current status of its business</li> </ul>
	June 22	<ul style="list-style-type: none"> <li>• Adopts plan to execute confirmation hearing about Chairman of Joint Chief of Staff appointee</li> <li>• Receives MMA's report on current status of its business</li> </ul>
	June 23	<ul style="list-style-type: none"> <li>• Adopts Resolution Denouncing North Korea for its attack on ROKS Cheonan and urges the ROK government to take Countermeasures</li> <li>• Receives DAPA's report on current status of its business</li> </ul>
	June 30	<ul style="list-style-type: none"> <li>• Holds confirmation hearing about Chairman of Joint Chief of Staff appointee Han Min-ko</li> <li>• Adopts a progress report on confirmation hearing about Chairman of Joint Chief of Staff appointee</li> </ul>
293 <sup>rd</sup> extraordinary session of National Assembly (August 1, 2010-August 31, 2010)	August 24	<ul style="list-style-type: none"> <li>• Receives MND's report on pending issue (i.e., countermeasures concerning attack on ROKS Cheonan) and readjusts schedule for return of wartime operational control</li> </ul>
	August 27	<ul style="list-style-type: none"> <li>• Receives accounts settlement for 2009 fiscal year</li> <li>• Passes account settlement for 2009 fiscal year</li> </ul>
294 <sup>th</sup> regular session of National Assembly (September 1, 2010-December 9, 2010)	October 4-October 22	<ul style="list-style-type: none"> <li>• Oversees functioning of 54 Governmental institutions, including MND and Joint Chiefs of Staff</li> </ul>
	November 11	<ul style="list-style-type: none"> <li>• Receives MND's report on pending issues, including plan to dispatch military cooperation corps to U.A.E.</li> </ul>
	November 30	<ul style="list-style-type: none"> <li>• Passes bill for 2010 budget</li> <li>• Receives MND's report on pending issues, including countermeasures taken against North's shelling of Yeonpyeong Island</li> </ul>

## Revision Details of Laws and Ordinances Related to the Ministry of National Defense (MND)

### Laws and ordinances overhauled (January 1, 2009 through November 30, 2010)

Laws	Presidential decrees	Ministerial ordinances	Total
34	58	55	147

### Laws

Name	Serial number of promulgation (date)	Revised Contents
Military Civilian Personnel Management Act	- Partially amended No. 9558 (April 1, 2009)	<ul style="list-style-type: none"> <li>• Concerning punishment of military civilians, demotion is inserted between dismissal and suspension from duty</li> <li>• Overhaul laws and ordinances to make them easier to understand</li> </ul>
Act on the Management of Logistics Supplies	- Partially amended No. 9559 (April 1, 2009)	<ul style="list-style-type: none"> <li>• With respect to commodities acquired by the Commissioner of the Defense Acquisition Program Administration (DAPA) and supplied for use or management by national defense agencies or respective services, the management of such commodities shall be deemed transferred when such commodities are delivered to national defense agencies or respective services</li> <li>• Expand right for lease of commodities</li> <li>• Expand list of commodities for emergency lease</li> <li>• Overhaul provisions for inventory inspection and adjustment</li> <li>• Abolish commodity price adjustment system</li> </ul>
Act on Flight Safety Certification of Military Planes	- Enacted No. 9560 (April 1, 2009)	<ul style="list-style-type: none"> <li>• Adopt Military Airworthiness Certification System.</li> <li>• Standardized Airworthiness Certification Criteria (Article 3)</li> <li>• Airworthiness certification procedure (Article 5)</li> <li>• Establish Airworthiness Certification Deliberation Committee (Article 7)</li> <li>• Designate military airworthiness certification expert institution (Article 11)</li> </ul>
Defense Acquisition Program Act	- Partially amended No. 9561 (April 1, 2009)	<ul style="list-style-type: none"> <li>• Make submission of Mid-Term Defense Program obligatory</li> <li>• Give SMEs priority in selection of an organization in charge of R&amp;D or a prototype manufacturer</li> <li>• Adopt business coordination application system</li> <li>• Expand scope of support for export promotion in defense industry sector</li> </ul>
Act on Compensation of Special Mission Performers	- Partially amended No. 9562 (April 1, 2009)	<ul style="list-style-type: none"> <li>• Extend period of application for compensation to October 31, 2011</li> </ul>
Act on Invalidation of the Suspended Court Marshall Ruling	- Abolition No. 9655 (May 8, 2009)	<ul style="list-style-type: none"> <li>• Abolish after relevant issues were addressed</li> </ul>

Name	Serial number of promulgation (date)	Description
Special Act on Support for Pyeongtaek Concerning Relocation of USFK Bases	- Partially amended No. 9674 (May 21, 2009)	<ul style="list-style-type: none"> <li>• The Defense Minister’s approval of a USFK installations-related business execution plan shall be deemed equal to having received the permission to use administrative assets under the State Properties Act</li> <li>• Place Project Group for Relocation of MND USFK Base Relocation Office under control of Defense Minister</li> <li>• Include revenue from entrusted development of state property returned from USFK as part of revenue from Special Accounts for Relocating USFK Bases</li> </ul>
Integrated Defense Act	- Partially amended No. 9675 (May 21, 2009)	<ul style="list-style-type: none"> <li>• Provide legal basis concerning issuance of watch status order, which has been operated under Presidential directives, to implement integrated defense measures more efficiently</li> <li>• Overhaul laws and ordinances to make them easier to understand</li> </ul>
Military Service Act	- Partially amended No. 9754 (June 9, 2009)	<ul style="list-style-type: none"> <li>• Provide basis for readjustment of service areas and entrusting repair of detailed service areas to public service personnel</li> <li>• Provide basis for postponing discharge of active-duty personnel receiving medical treatment</li> <li>• Provide basis for making it required for military volunteers to submit school transcripts</li> <li>• Define reason and procedure for extension of service concerning switchover service</li> <li>• Public service personnel are required to report changes of their status and are subject to disciplinary measures if they fail to file such reports</li> <li>• Provide basis for payment of allowance for ROTC cadets</li> <li>• Provide basis for early discharge of active-duty personnel found unqualified for military service</li> </ul>
Act on Implementation of the Ruling of the Military Court and Treatment of Military Confinees	- Wholly amended No. 9819 (November 2, 2009)	<ul style="list-style-type: none"> <li>• Insert a provision for respecting human rights of, and prohibited discrimination against, military confinees</li> <li>• Improve hygiene and medical treatment for military confinees</li> <li>• Enhance military confinees’ right to an attorney and improved letter censorship system</li> <li>• Provide legal basis for allowing phone conversations, subscription to newspapers, access to broadcast and writing</li> <li>• Insert provision on education and corrective programs for military inmates’ for social adaption</li> <li>• Ease leave requirements and provided legal basis for special leave</li> <li>• Provide legal basis for arresting escaped military confinees</li> <li>• Overhaul punitive regulations, including adoption of probation system</li> </ul>
Military Penal Code	- Partially amended No. 9820 (November 2, 2009)	<ul style="list-style-type: none"> <li>• Separate provision concerning the scope of spatial application</li> <li>• Reduce statutory punishment concerning desertion</li> <li>• Reduce statutory punishment concerning violent crime, intimidation, assault and other crimes</li> <li>• Readjust statutory punishment, including abolition of peace-time capital punishment in the case of offenses aggravated by consequence</li> <li>• Readjust statutory punishment in the case of the murder of a superior</li> <li>• Expand scope of offenses subject to fines</li> <li>• Insert provision for punishment for cruelty as with use of violent force</li> <li>• Overhaul provision concerning more severe punishment of military supply-related crimes</li> <li>• Insert provision for punishment of rape of, or forceful sexual harassment against female soldiers</li> </ul>

Name	Serial number of promulgation (date)	Description
Military Court Act	- Partially amended No. 9841 (December 29, 2009)	<ul style="list-style-type: none"> <li>• Abolish Act on the Military Court's Trial Right</li> <li>• Overhaul provision concerning protecting the value of confiscated articles</li> <li>• Overhaul provision concerning forceful disposition without warrant</li> <li>• Overhaul requirements for opening a court session</li> </ul>
Act on Special Measures concerning Military Supply-related Crimes	- Partially amended No. 9842 (December 29, 2009)	<ul style="list-style-type: none"> <li>• Apply realistic measures to physical scope of military supplies</li> <li>• Readjust scope of crimes subject to more severe punishment</li> <li>• Apply realistic measures to amount of fines</li> </ul>
Veterans' Pension Act	- Partially amended No. 9904 (December 31, 2009)	<ul style="list-style-type: none"> <li>• Concerning the stipulation that pension payments shall be partially reduced for a defendant sentenced to imprisonment or heavier while in service, the said stipulation shall not apply in the event of an offense perpetrated due to negligence not associated with the duty or as the result of following a standard order from a commanding officer</li> </ul>
Establishment of the Homeland Reserve Forces Act	- Partially amended No. 9945 (January 25, 2010)	<ul style="list-style-type: none"> <li>• A notice of the Homeland Reserve Forces training session can be delivered to the head or a member of the same household, when the reservist is not available. The provision concerning the delivery of a notice in the Civil Procedure Act shall apply mutatis mutandis, if required</li> <li>• Delete provision that required the Homeland Reserve Forces' company commanding officers to submit their men's applications for non-participation in ordinary/mobilization training sessions to the relevant military units</li> <li>• Include participation in the resource survey concerning personnel and supplies under the Emergency Resources Management Act in the duty of the Homeland Reserve forces' commanding officers</li> <li>• Readjust punitive measures (including a fine, in addition to imprisonment with hard labor) against Homeland Reserve Forces' company commanding officers involved in political activities</li> </ul>
Military Service Act	- Partially amended No. 9946 (January 25, 2010)	<ul style="list-style-type: none"> <li>• Allow regional military manpower administrations to dispatch military service duty-related notices via the information network</li> <li>• Separate military register of those transferred to on-the-ship reserve service status</li> <li>• Provide concrete criteria for enrollment as retired officers, including those who have finished ROTC courses, but not enrolled as active-duty officers</li> <li>• Stipulate conditions for cancellation of transfer to status of on-the-ship reserve service, the return to pre-transfer status, and the need to carry out military service duty</li> <li>• Delete provision on transfer of those judged to have a serious problem in carrying out military service due to the race or skin color to replacement or the 2<sup>nd</sup> conscription</li> <li>• Extend age limit for discharge or exemption from the physical examination for conscription, enrollment as an active-duty personnel or public service personnel to 36 and the age for such an exemption for draft-dodgers to 38</li> </ul>
Act on Recovery of Honor of Religious Victims of October 27, 1980	- Partially amended No. 9947 (January 25, 2010)	<ul style="list-style-type: none"> <li>• The validity of the Act is extended to June 30, 2013, as it was difficult to finish the objectives intended by the Act within the original timeline.</li> </ul>

Name	Serial number of promulgation (date)	Description
Korea Institute for Defense Analyses (KIDA) Act	- Partially amended No. 9994 (February 4, 2010)	<ul style="list-style-type: none"> <li>• Overhaul laws and ordinances to make them easy to understand</li> </ul>
Act on Formation of Basis for Defense Informatization and Management of Relevant Resources	- Enacted No. 9995 (February 4, 2010)	<ul style="list-style-type: none"> <li>• In connection with the Government's intention to promote strategic informatization for national security in an information-based society and economic informatization, through efficient management of national defense intelligence resources as part of defense informatization policy</li> <li>• The Act allows the Defense Minister to establish the Defense Informatization Basic Plan and ask the heads of the relevant administrative agencies to weigh the objectives of the basic plan when establishing and executing major policies.</li> </ul>
Military Personnel Management Act	- Partially amended No. 9996 (February 4, 2010)	<ul style="list-style-type: none"> <li>• Shorten minimum mandatory service period for candidates for promotion to Major General</li> </ul>
Act on Report and Disclose of Public Officials' Military Service Record	- Partially amended No. 10099 (March 17, 2010)	<ul style="list-style-type: none"> <li>• Exclude serial numbers from items to be disclosed concerning public officials' military service record</li> </ul>
Requisition Act	- Partially amended No. 10100 (March 17, 2010)	<ul style="list-style-type: none"> <li>• Overhaul laws and ordinances to make them easier to understand</li> </ul>
Act on Regulation of the Use and Transfer of Specific Conventional Weapons, including Landmines	- Partially amended No. 10101 (March 17, 2010)	<ul style="list-style-type: none"> <li>• Overhaul laws and ordinances to make them easier to understand</li> </ul>
Armed Forces Organization Act	- Partially amended No. 10102 (March 17, 2010)	<ul style="list-style-type: none"> <li>• Overhaul laws and ordinances to make them easier to understand</li> </ul>
Act on Establishment of the Armed Forces Nursing Academy	- Partially amended No. 10103 (March 17, 2010)	<ul style="list-style-type: none"> <li>• Overhaul laws and ordinances to make them easier to understand</li> </ul>
Military Telecommunications Act	- Partially amended No. 10104 (March 17, 2010)	<ul style="list-style-type: none"> <li>• The representative of a business, who has fulfilled his obligations for management and supervision of employees, is exempt from punishment so that the principle of liability is applied in the joint penal provision.</li> </ul>
War Memorial Korea Act	- Partially amended No. 10105 (March 17, 2010)	<ul style="list-style-type: none"> <li>• Allow individuals, corporations or organizations to donate or contribute to War Memorial</li> </ul>
Act on Prohibition of Unauthorized Use of Military Uniforms and Outfits	- Partially amended No. 10106 (March 17, 2010)	<ul style="list-style-type: none"> <li>• The representative of a business, who has fulfilled his obligations for management and supervision of employees, is exempt from punishment concerning the business in which his employees have perpetrated violations. (Overhaul of the joint penal provision).</li> <li>• Abolish handling fee collected at the time of receiving or changing a permit for businesses in production and sale of military uniforms and outfits</li> </ul>

Name	Serial number of promulgation (date)	Description
Military Civilian Personnel Management Act	- Partially amended No. 10192 (March 26, 2010)	<ul style="list-style-type: none"> <li>Promote ordinary military civilians to Grade-5 shall be addressed by the personnel committee, if required</li> </ul>
National Defense Reform Act	- Partially amended No. 10214 (March 31, 2010)	<ul style="list-style-type: none"> <li>Expand common positions at the Joint Chiefs of Staff, which have been assumed by general-level officers from each service on a rotational basis, to colonels</li> </ul>
Agency for Defense Development (ADD) Act	- Partially amended No. 10215 (March 31, 2010)	<ul style="list-style-type: none"> <li>Overhaul laws and ordinances to make them easier to understand</li> </ul>
Act on Installation of the Korea Army Academy at Yeongcheon	- Partially amended No. 10216 (March 31, 2010)	<ul style="list-style-type: none"> <li>Overhaul laws and ordinances to make them easier to understand</li> </ul>
Military Personnel Management Act	- Partially amended No. 10217 (March 31, 2010)	<ul style="list-style-type: none"> <li>General-level officers shall be assigned to designated positions available, but may be exceptionally assigned to positions in units dispatched to foreign countries. One not assigned to another position at the same level or higher after being dismissed from a position or end of the term of assignment shall be dismissed from active duty</li> <li>Make respectful expression for female members of military mandatory (i.e. from yeoja to yeosung)</li> </ul>
Defense Acquisition Program Act	- Partially amended No. 10218 (March 31, 2010)	<ul style="list-style-type: none"> <li>Add defense industry's contribution to national economic development to purpose and basic philosophy of the Act</li> <li>Tighten National Assembly control of defense acquisition programs' promotion</li> <li>Define qualification of ombudsmen</li> <li>Provide legal basis concerning R&amp;D analysis and appraisal</li> </ul>

## Presidential decrees

Name	Serial number of promulgation (date)	Description
Enforcement Decree of the Military Service Act	- Partially amended No. 21255 (January 7, 2009)	<ul style="list-style-type: none"> <li>The transfer of defense science and technology does not have to go through the deliberation of the Defense Acquisition Program Promotion Committee.</li> <li>Make it possible to secure raw materials and parts with the approval of the DAPA prior to signing the contract, concerning a long-term contract between the DAPA and a defense contractor</li> </ul>
Enforcement Decree of the Military Service Act	- Partially amended No. 21256 (January 7, 2009)	<ul style="list-style-type: none"> <li>Extend postponement period for carrying out military service duty for those who have taken a job after graduation from a professional high school in consideration of fairness in comparison with university students</li> </ul>

Name	Serial number of promulgation (date)	Description
Provision on payment of overseas allowance to uniformed soldiers and military civilians	- Partially amended No. 21257 (January 7, 2009)	<ul style="list-style-type: none"> <li>• Make additional, officer-level allowances to warrant officers, non-commissioned officers and military civilians in charge of health mandatory</li> <li>• Base allowance payment on average annual won-dollar exchange rate in previous year to reduce gap</li> </ul>
Enforcement Decree of the Special Act on Fact-finding of Dubious Death of Uniformed soldiers	- Partially amended No. 21266 (January 16, 2009)	<ul style="list-style-type: none"> <li>• Overhaul secretariat organization designed to guarantee neutrality and expertise of Uniformed Soldiers Dubious Death Fact-Finding Committee</li> <li>• Adopt system of closing a case in which the relevant party has withdrawn its request for investigation after commencement of investigation</li> </ul>
Enforcement Decree of the Act on Repatriation and Treatment of Prisoners of War	- Partially amended No. 21378 (March 31, 2009)	<ul style="list-style-type: none"> <li>• Provide counseling and training for those held as POWs in North Korea; promotion of overall understanding of social, cultural and economic activities in the ROK under the amendment to the Act on Repatriation and Treatment of Prisoners of War (Law No. 9289 promulgated on December 31, 2008 and implemented in April 1, 2009)</li> </ul>
Organization of the Joint Chiefs of Staff Act	- Partially amended No. 21379 (March 31, 2009)	<ul style="list-style-type: none"> <li>• Readjust duties of the Joint Chiefs of Staff</li> <li>• Reorganize staff offices of the Joint Chiefs of Staff</li> <li>• Readjust staff office assignments</li> </ul>
Act on the Organizations of the Office of Military Manpower Administration (MMA) and Its Subsidiary Institutions	- Partially amended No. 21393 (March 31, 2009)	<ul style="list-style-type: none"> <li>• Reorganize subunits into larger departments</li> <li>• Reduce number of high-ranking officials by one</li> <li>• Reduce number of director general-level positions that could be filled by contract-based officials from 3 to 2</li> </ul>
Decree concerning military attachés in foreign embassies	- Partially amended No. 21426 (April 20, 2009)	<ul style="list-style-type: none"> <li>• Require Defense Minister to control and supervise military matters that should be fixed in consultation between Defense Minister and Foreign Minister</li> <li>• Require setting tables of organization of military attachés in ROK embassies in foreign countries and for the Defense Minister to consult with the Foreign Minister concerning (a change in) the tables of organization for military attaches in individual embassies</li> </ul>
Act on the Organization of the MND and Its Subsidiary Institutions	- Partially amended No. 21472 (May 6, 2009)	<ul style="list-style-type: none"> <li>• Reorganize subunits into larger departments to integrate similar functions</li> <li>• Reorganize MND organization and functions, including reinforcement of functions related to North Korea, the U.S. and international policies, to improve efficiency</li> </ul>
Enforcement Decree of the Act on Compensation to Special Mission Performers	- Partially amended No. 21504 (May 28, 2009)	<ul style="list-style-type: none"> <li>• Assign Special Mission Performers Compensation Deliberation Committee's administrative matters to the Support Team for Compensation to Persons Engaged in Special Military Mission of the MND handles a</li> <li>• Make secretary of said committee Chief of the Support Team for Compensation to Persons Engaged in Special Military Mission</li> </ul>
Act on the Organizations of the Office of Military Manpower Administration (MMA) and Its Subsidiary Institutions	- Partially amended No. 21521 (June 2, 2009)	<ul style="list-style-type: none"> <li>• Grade-3 or 4 officials at the headquarters of the MMA can be assigned to the positions of subsidiary institutions.</li> <li>• Delete provision on how many positions can be filled by contract-based officials</li> </ul>

Name	Serial number of promulgation (date)	Description
Enforcement Decree of the Military Civilian Personnel Act	- Partially amended No. 21595 (July 1, 2009)	<ul style="list-style-type: none"> <li>• Change calculation of minimum period required for promotion</li> <li>• Limit opportunity for promotion concerning those with records of punishment with demotion</li> <li>• Readjust scores/scoring factors concerning candidates for promotion</li> <li>• Provide basis for reemployment screening for civilian professors</li> </ul>
Enforcement Decree of the Defense Acquisition Program Act	- Partially amended No. 21596 (July 1, 2009)	<ul style="list-style-type: none"> <li>• Stipulate detailed requirements for offset trade</li> <li>• Adopt performance-based logistical support system</li> <li>• Expand scope of defense supplies</li> <li>• Detail fact-finding procedure for project coordination system</li> </ul>
Decree concerning the Armed Forces Printing Depot	- Enacted No. 21597 (July 1, 2009)	<ul style="list-style-type: none"> <li>• Establish Armed Forces Printing Depot by integrating printing depots of respective services to improve operation of non-combat management military units under Defense Reform Basic Plan</li> </ul>
Enforcement Decree of the Act on Designation and Operation of Military Executive Agencies	- Partially amended No. 21598 (July 1, 2009)	<ul style="list-style-type: none"> <li>• Provide legal basis for establishment of Armed Forces Printing Depot as Military Executive Agency</li> </ul>
Enforcement Decree of the Military Personnel Act	- Partially amended No. 21651 (July 30, 2009)	<ul style="list-style-type: none"> <li>• Adopt Reserve Officer Candidates System</li> <li>• Allow warrant officers and non-commissioned officers to take part in Deliberation Committee on Discharge from Active Duty</li> <li>• Make it possible to use the maternity leave period on several occasions and fill in the void caused by those on maternity leave</li> </ul>
Enforcement Decree of the Act on Flight Safety Certification of Military Planes	- Enacted No. 21652 (July 30, 2009)	<ul style="list-style-type: none"> <li>• Detail airworthiness certification types</li> <li>• Exclude application of standard airworthiness certification standards</li> <li>• Set matters concerning composition and operation of Airworthiness Certification Deliberation Committee and Working-level Technological Committee</li> </ul>
Enforcement Decree of The Special Act on Support for Pyeongtaek concerning Relocation of USFK Bases	- Partially amended No. 21733 (September 17, 2009)	<ul style="list-style-type: none"> <li>• Stipulate matters concerning organization and operation of project group entrusted under the amended laws and the criteria for imposition of fines on Pyeongtaek Development Project contractors</li> </ul>
MURO (MND USFK Base Relocation Office) Regulations	- Abolished No. 21733 (September 17, 2009)	<ul style="list-style-type: none"> <li>• Abolish regulations within Additional Rules of the Enforcement Decree of The Special Act on Support for Pyeongtaek concerning Relocation of USFK Bases</li> </ul>
Military Personnel Service Discipline	- Partially amended No. 21750 (September 29, 2009)	<ul style="list-style-type: none"> <li>• Clearly define the concept of superiors in the military command system</li> <li>• Imposed obligation of honoring and respecting others when using military information network</li> <li>• Mandatory for both commanding officers and subordinates to respect each other when carrying out duties</li> </ul>
Enforcement Decree of the Logistics Supplies Management Act	- Partially amended No. 21751 (September 29, 2009)	<ul style="list-style-type: none"> <li>• Provide basis of performance-based logistical support system</li> <li>• Detail cases in which scrapping of ammunition is improper at ammunition demilitarization facilities</li> <li>• Expand scope of the rights for lease or transfer of military supplies</li> <li>• Overhaul Military Supply Inspection Committee</li> </ul>



Name	Serial number of promulgation (date)	Description
Act on the Organizations of the Office of Military Manpower Administration (MMA) and Its Subsidiary Institutions	- Partially amended No. 21754 (September 29, 2009)	<ul style="list-style-type: none"> <li>• Those officials (i.e. five Grade-6 and three Grade-7) needed to reinforce the military draft physical examination, including a precision psychological test through a clinical psychologist, are reflected in the tables of organization of the subsidiary institution of the MMA.</li> </ul>
Regulations on Military-entrusted Students	- Partially amended No. 21779 (October 19, 2009)	<ul style="list-style-type: none"> <li>• Readjust scope of expenses paid to military-entrusted students in foreign countries</li> <li>• Reinforce criteria for calculation of expenses to be returned to the state concerning those dismissed while attending a military-provided educational program</li> </ul>
Enforcement Decree of the Act on Establishment of the Korea National Defense University	- Partially amended No. 21780 (October 19, 2009)	<ul style="list-style-type: none"> <li>• Expand scope of those eligible for diploma courses offered by the National Defense University to active-duty warrant officers, non-commissioned officers, and military civilians, in addition to officers and public officials</li> </ul>
Enforcement Decree of the Military Personnel Act	- Partially amended No. 21821 (November 13, 2009)	<ul style="list-style-type: none"> <li>• In the case of those hired by an international organization, inclusion of the original temporary retirement period in the service period is not required.</li> <li>• Supplement procedure for designation of the positions of professionals</li> </ul>
Enforcement Decree of the Act on Protection of Military Base and Installations	- Partially amended No. 21826 (November 17, 2009)	<ul style="list-style-type: none"> <li>• Readjust scope of military installation protection zones at time of an administrative disposition that requires consultation with Defense Minister</li> <li>• Lift designation of Helicopter Base in Chuncheon as military installation protection zone</li> <li>• Improve size/shape of milestones for military installation protection zones</li> </ul>
Enforcement Decree of the Integrated Defense Act	- Partially amended No. 21827 (November 17, 2009)	<ul style="list-style-type: none"> <li>• Provide basis for integrated defense meeting</li> <li>• Bestow regiment commander-level military officer or police chief or higher the right to issue an order for a "watch" status and specified Class-I/II/III watch statuses</li> <li>• Stipulate how chain of command should be established and mutual cooperation should be made when integrated defense situation is announced</li> </ul>
Enforcement of Decree of the Act on Establishment of Homeland Reserve Forces	-Partially amended No. 21859 (November 30, 2009)	<ul style="list-style-type: none"> <li>• Launch regional units as part of Homeland Reserve Forces' local units</li> <li>• Permit reservists to take part in training carried out outside his area</li> <li>• Set number of hours for training Homeland Reserve Forces and the procedure for delivery of the notice concerning training sessions via electronic means</li> </ul>
Enforcement Decree of the Military Service Act	- Partially amended No. 21867 (December 7, 2009)	<ul style="list-style-type: none"> <li>• Postpone discharge of active-duty personnel receiving medical treatment</li> <li>• Stipulate education carried out for those newly transferred to on-the-ship reserve service</li> <li>• Subcategorize service areas for public service personnel</li> <li>• Ease conditions for transfer of specialized research personnel and skilled industry personnel</li> </ul>

Name	Serial number of promulgation (date)	Description
Regulations on payment of honorable retirement allowance	- Partially amended No. 21884 (December 15, 2009)	<ul style="list-style-type: none"> <li>• Expand scope of public officials from whom honorable retirement allowances should be withdrawn</li> <li>• Change criteria for calculating amount of withdrawal</li> <li>• Readjust demurrage rate in regard to amount of withdrawal</li> </ul>
Enforcement Decree of the Military Personnel Act	- Partially amended No. 21893 (December No. 21, 2009)	<ul style="list-style-type: none"> <li>• Readjust positions subject to term-based promotion</li> </ul>
Decree concerning the Defense Intelligence Agency (DIA)	- Partially amended No. 21915 (December 30, 2009)	<ul style="list-style-type: none"> <li>• List tasks that DIA should carry out in preparation for return of Wartime Operational Control</li> <li>• Establish ROK Cyber Command as subsidiary unit of DIA</li> </ul>
Enforcement Decree of the Military Pension Act	- Partially amended No. 21993 (January 18, 2010)	<ul style="list-style-type: none"> <li>• Replace requirement for submittal of seal impression power of attorney with copy of public institution-issued ID and signature at the time of applying for bereaved family allowance</li> </ul>
Decree concerning the Defense Security Command (DSC)	- Partially amended No. 22007 (February 4, 2010)	<ul style="list-style-type: none"> <li>• Enhance decree-related system, including setting scope and content of DSC duties</li> </ul>
Decree concerning Defense Transportation Command	- Partially amended No. 22078 (March 23, 2010)	<ul style="list-style-type: none"> <li>• Overhaul regulations for assignment of Defense Transportation Command as a joint unit and operation of its subsidiary units</li> </ul>
Regulations on the operational units of each service whose main duty is combating under the Armed Forces Organization Act, Article 9, Paragraph 3	- Partially amended No. 22079 (March 23, 2010)	<ul style="list-style-type: none"> <li>• Include Defense Transportation Command in joint units for efficient provision of support for joint operations</li> <li>• Overhaul laws and ordinances to make them easier to understand</li> </ul>
Enforcement Decree of the Military Civilian Personnel Act	- Partially amended No. 22089 (March 26, 2010)	<ul style="list-style-type: none"> <li>• Overhaul job groups/job lines system and evaluation system of military-employed civilians</li> <li>• Extend retirement age military civilians in special positions</li> </ul>
Enforcement Decree of the Act on Implementation of the Ruling of the Military Court and Treatment of Confines	- Wholly amended No. 22137 (April 29, 2010)	<ul style="list-style-type: none"> <li>• Subcategorize solitary confinement</li> <li>• Improve system for supervision of those in solitary confinement</li> <li>• Provide improved hygiene and medical service conditions to military confines</li> <li>• Guaranteed military prisoners' right to an attorney and improved letter censorship system</li> </ul>
Enforcement Decree of the Special Act on Fact-finding of Dubious Death of Uniformed Soldiers	- Abolished No. 22165 (May 25, 2010)	<ul style="list-style-type: none"> <li>• The said enforcement is abolished when the Act expired on December 31, 2009</li> </ul>
Enforcement Decree of the Military Personnel Act	- Amended No. 22215 (June 28, 2010)	<ul style="list-style-type: none"> <li>• Set the positions to which general-level officers can be assigned under amended Military Personnel Management Act</li> <li>• Expand eligibility for application for selection of service academy cadets to equivalent of four-year college graduates and those holding similar academic background</li> </ul>

Name	Serial number of promulgation (date)	Description
Regulations on the Advanced Defense Promotion Committee	- Enacted No. 22271 (July 12, 2010)	<ul style="list-style-type: none"> <li>• Composition and operation of the Presidential Advanced Defense Promotion Committee launched as a body providing advice to the President on matters concerning advanced defense posture</li> </ul>
Enforcement Decree of the Requisition Act	- Amended No. 22272 (July 12, 2010)	<ul style="list-style-type: none"> <li>• Overhaul detailed criteria for compensation of items requisitioned</li> <li>• Specify composition and operation of Requisition Compensation Deliberation Committee</li> </ul>
Act on the Organization of the MND and Its Subsidiary Institutions	- Amended No. 22287 (July 21, 2010)	<ul style="list-style-type: none"> <li>• Office of National Defense Reform extended by one more year</li> <li>• Increase number of employees whose employment status was confirmed according to need of military for 2010 by 13</li> <li>• Transfer of seven specified positions that could be filled only by administrative officials with the proper status to ordinary or multiple special positions that can be filled with any candidate possessing sufficient administrative or technical skills</li> <li>• Comprehensively stipulate allocation of assignments for ancillary/ advisory institutions</li> </ul>
Enforcement Decree of the Military Civilian Personnel Act	- Amended No. 22345 (August 17, 2010)	<ul style="list-style-type: none"> <li>• Stipulate promotion of ordinary military civilians to Grade-5 to put procedures in line with those from Public Official Employment Decree</li> </ul>
Enforcement Decree of the Military Pension Act	- Amended No. 22355 (August 25, 2010)	<ul style="list-style-type: none"> <li>• Provide proper level of compensation through upward adjustment of military death depending on cause</li> </ul>
Enforcement Decree of the National Defense Reform Act	- Partially Amended No. 22412 (October 1, 2010)	<ul style="list-style-type: none"> <li>• Expand common positions of Joint Chiefs of Staff, heretofore general-level officers from each service on a rotational basis, to include colonels, in step with amendment to the law</li> </ul>
Enforcement Decree of the Defense Acquisition Program Act	- Partially amended No. 22413 (October 1, 2010)	<ul style="list-style-type: none"> <li>• Overhaul ombudsman provisions and types of strategic weapons businesses subject to approval and matters to be entrusted, including approval procedures, in step with amendment to Defense Acquisition Program Act</li> <li>• Stipulate methods and procedure for purchase of military supplies</li> </ul>
Enforcement Decree of the Military Service Act	- Partially amended No. 22414 (October 1, 2010)	<ul style="list-style-type: none"> <li>• Include Ph.D. courses, newly commenced by Daegu Gyeongbuk Institute of Science &amp; Technology, on the list of research programs in which specialized research personnel may be engaged</li> <li>• Classify full-time reservists as dependents when incorporated into 2<sup>nd</sup> conscription category due to household situation</li> <li>• Strike those judged improper for replacement service during screening from list of those subject to service call</li> </ul>
Presidential Decree on Resident Military Attaches Assigned to Overseas Diplomatic and Consular Missions	- Partially amended No. 22415 (October 1, 2010)	<ul style="list-style-type: none"> <li>• Increase number of military attaches assigned to overseas diplomatic and consular missions so as to reinforce military diplomatic relations with foreign countries</li> </ul>

Name	Serial number of promulgation (date)	Description
Air Force Headquarters Organization	- Wholly amended No. 22430 (October 13, 2010)	<ul style="list-style-type: none"> <li>Overhaul regulations, including division of Policy PR Office to Policy Office and TI&amp;E Office, and added medical services to responsibilities of Personnel Staff Office</li> </ul>
Armed Forces Medical Command Decree	-Partially amended No. 22431 (October 13, 2010)	<ul style="list-style-type: none"> <li>Complete basis for establishing Armed Forces Medical School and Military Combined Hospital under direct control of Armed Forces Medical Command</li> <li>Abolish Armed Forces Medical School Decree and Military Combined Hospital Decree</li> </ul>
Army Logistics Command Decree	-Wholly amended No. 22432 (October 13, 2010)	<ul style="list-style-type: none"> <li>Overhaul Army Logistics Command's system, deleting from its duties matters concerning military assistance and improvement of equipment and supplies – other than logistical support</li> </ul>
The Army Combat Development Corps Decree	-Abolished No. 22433 (October 13, 2010)	<ul style="list-style-type: none"> <li>Abolish Army Combat Development Corps and transferred its duties and organization to Army Training Command</li> </ul>
Army Headquarters Organization	-Wholly amended No. 22434 (October 13, 2010)	<ul style="list-style-type: none"> <li>Overhaul system, dividing Policy PR Office duties between Policy Office and TI&amp;E Office,</li> <li>Add Army Reform Office and transferred veteran support from Personnel Staff Office to Army Personnel Command</li> </ul>
Navy Headquarters Organization	-Wholly amended No. 22435 (October 13, 2010)	<ul style="list-style-type: none"> <li>Overhaul system, dividing Policy PR Office duties between Policy Office and TI&amp;E Office and made medical services the responsibility of Personnel Staff Office</li> </ul>
Marine Corps Command Organization	- Wholly amended No. 22436 (October 13, 2010)	<ul style="list-style-type: none"> <li>Overhaul system, including integrating combat-related functions, creating Chief of Staff position to supervise general staff functions, and reorganizing Personnel Staff Office</li> </ul>
Organization of the Defense Acquisition Program Administration and its affiliated institutions	- Partially amended No. 22438 (October 13, 2010)	<ul style="list-style-type: none"> <li>Add four working-level employees to Communications Office for records management</li> <li>Change Cost Management Department in the Contract Management Division into Cost Accounting Verification Corps that reports directly to head of Contract Management Division</li> </ul>
Enforcement Decree of the Act on Compensation to Special Mission Performers	-Partially amended No. 22460 (October 27, 2010)	<ul style="list-style-type: none"> <li>Clearly define training and educational period concerning special missions, which form the basis for eligibility for special missions</li> </ul>

## Ministerial ordinances

Name	Serial number of promulgation (date)	Description
Enforcement Rules of the Defense Acquisition Program Act	- Partially amended No. 668 (January 7, 2009)	<ul style="list-style-type: none"> <li>• In regard to long-term contracts between DAPA and defense contractors: a defense contractor can ask for confirmation of quality by securing raw materials and parts with DAPA approval prior to signing the contract, as part of the overhaul of the relevant provisions in accordance with the amendment to the relevant enforcement decree</li> </ul>
Enforcement Rules of the Act on Flight Safety Certification of Military Planes	- Partially amended No. 669 (January 23, 2009)	<ul style="list-style-type: none"> <li>• Ease criteria for more severe punishment concerning repeated offences</li> <li>• Ease criteria for disposition concerning a case involving danger of mid-air collision</li> </ul>
Rules on the military draft physical examination	- Partially amended No. 670 (January 28, 2009)	<ul style="list-style-type: none"> <li>• Abolish method of judging examinees' physical status based on points totaled</li> <li>• End practice of measuring height and weight at boot camp and at time of physical examination in order to change military service-related status</li> <li>• Add more stringent criteria for judgment of physical status rather than relying merely on height and weight</li> </ul>
Enforcement Rules of the Military Civilian Personnel Management Act	- Partially amended No. 671 (February 10, 2009)	<ul style="list-style-type: none"> <li>• Delete appearance as a factor of judgment of an interviewee in recruitment</li> <li>• Readjust written test subjects in recruitment of ordinary military civilians</li> <li>• Overhaul criteria for giving bonus points to holders of licenses and qualification certification in promotion</li> </ul>
Enforcement Rules of the Act on Prohibition of Unauthorized Use of Military Uniforms and Outfits	- Partially amended No. 672 (February 10, 2009)	<ul style="list-style-type: none"> <li>• Detail factors for imposing more severe/lighter administrative disposition</li> <li>• Add alleviation criteria concerning cancellation of business permits</li> </ul>
Rules on Special Allowance Paid to Uniformed Soldiers	- Partially amended No. 673 (February 19, 2009)	<ul style="list-style-type: none"> <li>• Upward adjustment of allowance for submarine crews</li> </ul>
Rules on payment of down payment and interim payment to defense industry contractors	- Partially amended No. 674 (March 25, 2009)	<ul style="list-style-type: none"> <li>• Expand down payment period from 90 days to 180 days for earlier budget execution</li> <li>• Increase interim payment from 20% to 30% for contracts in excess of 1 billion won</li> </ul>
Enforcement Rules of the Act on Repatriation and Treatment of Prisoners of War	- Partially amended No. 675 (April 1, 2009)	<ul style="list-style-type: none"> <li>• Amend law, enforcement decree and measures required for execution, including designation of application form for social adaptation education, under amendment to Act</li> </ul>
Enforcement Rules of the Act on the Organizations of the Office of Military Manpower Administration (MMA) and Its Subsidiary Institutions	- Partially amended No. 676 (April 8, 2009)	<ul style="list-style-type: none"> <li>• Change department names following reorganization and reallocated assignments</li> <li>• Reorganize regional military manpower administrations and reallocated assignments</li> </ul>
Military Act Enforcement Regulation	Partially amended No. 677 (May 25, 2009)	<ul style="list-style-type: none"> <li>• Allow public service personnel who submit justifiable reasons for returning to school to flexibly adjust annual leave periods according to year of service, within the total number of annual leave days set by different service requirements</li> </ul>
Enforcement Rules of the Act on the organization of the DAPA and its subsidiary institutions	- Partially amended No. 678 (May 26, 2009)	<ul style="list-style-type: none"> <li>• Stipulate assignments for newly launched Certification Planning Division and Export Promotion Division in detail</li> <li>• Change names from Office of Business Consultation to Customer Service Center and from Financial Officer to Financial Operation Officer</li> </ul>

Name	Serial number of promulgation (date)	Description
Enforcement Rules of the Act on the Organization of the MND and Its Subsidiary Institutions	- Partially amended No. 679 (May 26, 2009)	<ul style="list-style-type: none"> <li>• Stipulate assignments for newly launched positions, i.e. Budget Compilation Officer and Private Investment Officer, in detail; and readjusted assignments of relevant departments in connection with reorganization of the MND and its subsidiaries (under Presidential Decree No. 21472 promulgated and implemented on May 6, 2009)</li> </ul>
Enforcement Rules of the Act on the Organizations of the Office of Military Manpower Administration (MMA) and Its Subsidiary Institutions	- Partially amended No. 680 (June 25, 2009)	<ul style="list-style-type: none"> <li>• Overhaul relevant regulations in connection with reorganization of MMA and its subsidiaries, including making it possible to reassign Grade-3/4 officials at MMA headquarters as heads of regional military manpower administrations in Gyeongnam-do or Gyeonggi-do</li> <li>• Amend General Rules on the Organization and Tables of Organization of Administrative Institutions to make it possible to fill vacancies with contract-based officials by means of the Prime Minister's Ordinance or ministerial ordinance</li> </ul>
Enforcement Rules of the Defense Acquisition Program Act	- Partially amended No. 681 (July 1, 2009)	<ul style="list-style-type: none"> <li>• Overhaul relevant regulations under amendment to Defense Acquisition Program Act (Law No. 9561 promulgated on April 1, 2009, and implemented on July 2 the same year)</li> <li>• Stipulate form of program coordination agreement and documents to be attached to program coordination application</li> <li>• Stipulate details required for promotion and use of locally produced parts</li> </ul>
Rules on the Military Prosecutors Office's handling of cases	- Wholly amended No. 682 (July 6, 2009)	<ul style="list-style-type: none"> <li>• Change the Rules on the Military Prosecutor's Office's handling of administrative matters to the Rules on the cases handled by the Military Prosecutor's Office</li> <li>• Overhaul case investigation procedures</li> <li>• Stipulate the procedure for handling cases and public trials</li> <li>• Stipulate appealing to the Supreme Court, whistle blowing, the procedure at the Military Appellate Prosecutor's Office, the procedure for appealing to the Constitution Court, and a measure taken to limit communication</li> </ul>
Rules on the Defense Minister's authority over the heads of the subsidiary administrations	- Partially amended No. 683 (July 6, 2009)	<ul style="list-style-type: none"> <li>• Reorganize MND subsidiaries and their assignments for smoother information sharing</li> <li>• Require MND's subsidiary administration heads to report overseas travel plans to Defense Minister</li> <li>• Require notification of a change in personnel affairs concerning high-ranking aids to Defense Minister</li> </ul>
Enforcement Rules of the Act on Flight Safety Certification of Military Planes	- Enacted No. 684 (August 5, 2009)	<ul style="list-style-type: none"> <li>• Stipulate enforcement and implementation in connection with Act on Flight Safety Certification of Military Planes (Law No. 9560 promulgated on April 1, 2009 and implemented on August 1 the same year)</li> </ul>
Enforcement Rules of the Military Personnel Management Act	- Partially amended No. 685 (August 13, 2009)	<ul style="list-style-type: none"> <li>• Requirements for implementation of amendment to relevant Enforcement Decree (Presidential Decree No. 21651 promulgated and implemented on July 30, 2009), which made it possible for warrant officers and non-commissioned officers to take part in committees, including Long-Term Service Eligibility Screening Committee and adopted reserve officer candidates system to secure talented military officers</li> <li>• Delete appearance as review category when interviewing female recruits for officer positions</li> </ul>
Rules on selection of reserve force commander	- Partially amended No. 686 (August 31, 2009)	<ul style="list-style-type: none"> <li>• Include Navy and Air Force military police in regard to applicable branches in examination for Reserve Forces commanding officer recruitment to promote equity between each service</li> <li>• Improve conversion methods for active-duty personnel performance scores</li> <li>• Physical examination mandatory only for those who passed written test</li> </ul>

Name	Serial number of promulgation (date)	Description
Rules on administrative measures for preservation of records of the Military Prosecutor's Office	- Enacted No. 687 (October 5, 2009)	<ul style="list-style-type: none"> <li>Specify record preservation procedures for court rulings, unprosecuted cases, and cases associated with complaints or internal investigation at Military Prosecutor's Office</li> </ul>
Rules on inspection and reproduction of military criminal case records and handling charges	- Enacted No. 688 (October 5, 2009)	<ul style="list-style-type: none"> <li>Stipulate handling fees and methods of certification for perusal and reproduction of military criminal case records, issuance of photocopies or abstracts of court rulings, or certifications concerning specific cases</li> </ul>
Enforcement Rules of the Regulations on Military-entrusted Students	- Partially amended No. 689 (October 19, 2009)	<ul style="list-style-type: none"> <li>Provide legal basis for Defense Minister's instruction requiring chiefs of staff of each service to comply with request for submittal of documents, such as physical checkup results, concerning military-entrusted students studying abroad</li> <li>Delete regulation concerning matters to be observed and reported by military-entrusted students in connection with fact that they are covered by Military-entrusted Students Regulations</li> </ul>
Rules on Recruitment of Students for National Defense University and collection of tuition fees	- Partially amended No. 690 (October 19, 2009)	<ul style="list-style-type: none"> <li>Overhaul relevant regulations to make it possible to adjust number of those admitted to diploma courses offered by National Defense University annually in accordance with prevalent situation</li> </ul>
Enforcement Office of Military Manpower Administration and its subsidiary institutions rules	- Partially amended No. 691 (October 22, 2009)	<ul style="list-style-type: none"> <li>Increase number of junior medical technicians by 8</li> <li>Provide basis for converting 22 menial function positions to general positions</li> </ul>
Enforcement Rules on the Organization of the MND and Its Subsidiary institutions	- Wholly amended No. 692 (October 23, 2009)	<ul style="list-style-type: none"> <li>Provide basis of converting status of 19 menial function positions to general positions under amendment to Public Official Employment Decree (Presidential Decree No. 21717 promulgated and implemented on September 8, 2009)</li> </ul>
Enforcement Rules of the Act on the organization of the DAPA and its subsidiary institutions	- Partially amended No. 693 (October 23, 2009)	<ul style="list-style-type: none"> <li>Expand positions that can be filled in with either Grade-6 administrative officials or Grade-6 technological officials</li> <li>Provide basis of converting status of 10 menial function positions to general positions</li> </ul>
Enforcement Rules of the Logistics Supplies Management Act	-Partially amended No. 694 (November 6, 2009)	<ul style="list-style-type: none"> <li>Computerize hand-written supply management /supply operation log books of asset files operated under Military Logistics Information System</li> <li>Overhaul of terminologies and expression to make them easy to understand</li> </ul>
Rules on Special Allowance Paid to Uniformed Soldiers	- Partially amended No. 695 (November 6, 2009)	<ul style="list-style-type: none"> <li>In regard to basic (300,000 won/month) allowance included in incentive pay for volunteer enlisted soldiers, recipients can claim the sum of basic allowance payments for the extended service period on the first remuneration pay day upon request</li> </ul>
Rules on Recruitment of Personnel in charge of Management of Matters concerning Reserve Forces	-Partially amended No. 696 (November 12, 2009)	<ul style="list-style-type: none"> <li>Change name of existing rules so they may be applied to recruitment of Management of Reserve Forces personnel</li> <li>Change rank of Homeland Reserve Forces company commanding officers from retired major/captain to retired major</li> <li>Require applicants for Management of Reserve Forces positions to pay handling fees based on the category and position</li> <li>Readjust subjects of the written test and points allocated</li> </ul>

Name	Serial number of promulgation (date)	Description
Enforcement Rules of the Act on Protection of Military Base and Installations	- Partially amended No. 697 (November 24, 2009)	<ul style="list-style-type: none"> <li>• Reflects amendment to following Act, mutatis mutandis, in defense minister's consultations with chiefs of relevant administrative institutions, concerning permission to enter military installation in protected zones associated with explosives</li> <li>• The Act on Special Measures for Designation and Management of Areas of Restricted Development, its Enforcement Decree, Schedule 1-2 (the Presidential Decree No. 21670 promulgated on August 5, 2009 and implemented on August 7 the same year)</li> </ul>
Enforcement Rules of the Establishment of the Homeland Reserve Forces	- Partially amended No. 698 (November 30, 2009)	<ul style="list-style-type: none"> <li>• Require recruit reserve forces commanding officers to pass test for reserve forces management business</li> </ul>
Military Service Act Enforcement Regulations	- Partially amended No. 699 (December 10, 2009)	<ul style="list-style-type: none"> <li>• In regard to matters (such as notification for refresher training of public service personnel), required for implementation of amendment to Military Service Act (Law No. 9754 promulgated on June 9, 2009 and implemented on December 10 the same year) and its Enforcement Decree (Presidential Decree No. 21867 promulgated on December 7, 2009 implemented on December 10 the same year)</li> <li>• Concerning application for split military service made by a member of administrative support personnel: replaced requirement for submitting diagnosis issued by military authorities with diagnosis issued by medical institution</li> </ul>
Enforcement Rules of the Military Personnel Disciplinary Punishment Ordinance	- Partially amended No. 700 (December 30, 2009)	<ul style="list-style-type: none"> <li>• Lay out different types of major misconducts, such as violation of obligation for faithfulness, obedience, staying in a designated service place and keeping dignity, involving officers, warrant officers, and non-commissioned officers stated in Schedule-1 in said Rules</li> </ul>
Rules on Safe Operation of Ships	- Partially amended No. 701 (January 14, 2010)	<ul style="list-style-type: none"> <li>• Form Fishing Protection Headquarters and coordination of matters concerning its operation</li> <li>• Readjust scope of Report Post functions and converted Joint Report Posts to Report Posts</li> <li>• Ease procedure for reporting a ship's departure from and return to a port</li> <li>• Expand legitimate reasons for breaking from a group of fishing vessels during fishing operation</li> <li>• Abolish identification signal system</li> </ul>
Rules on military draft physical examination	- Partially amended No. 702 (February 17, 2010)	<ul style="list-style-type: none"> <li>• Rationally and objectively categorized mental/physical illnesses or disorders weighed as part of a judgment of physical condition</li> </ul>
Rules on Military Prosecutors Office's administrative measures for depriving offender's property	- Enactment No. 703 (February 17, 2010)	<ul style="list-style-type: none"> <li>• Set out detailed procedures for implementation of measures for seizing offender's property</li> <li>• Stipulate procedure for Military Prosecutor's Office handling fines paid to national treasury and payment of fines prior to coordination</li> <li>• Stipulate matters, such as forceful implementation procedure and payment of fines</li> <li>• Stipulate matters, such as adjustment of time-based fines and matter related: required payment, procedure for payment, appeal process, and procedure for refunds</li> </ul>
Rules on establishment and supervision of non-profit corporations under the control of the MND and its subsidiary institutions	- Partially amended No. 704 (March 9, 2010)	<ul style="list-style-type: none"> <li>• Stipulate mandatory period within which to handle the business of non-profit corporations in accordance with relevant provisions and stipulated the documents to be submitted</li> <li>• Simplify wording of rules</li> </ul>



Name	Serial number of promulgation (date)	Description
Rules on Recruitment of Personnel in charge of Management of Matters concerning Reserve Forces	- Partially amended No. 705 (March 10, 2010)	<ul style="list-style-type: none"> <li>• Change term reserve troops management to reserve forces management in connection with establishment of Reserve Forces Management Authority</li> <li>• Clearly define the scope of the recruitment test for the officials in charge of reserve forces management</li> </ul>
Enforcement Rules on the Organization of the MND and Its Subsidiary Institutions	- Partially amended No. 706 (March 12, 2010)	<ul style="list-style-type: none"> <li>• Provide basis for changing status of 19 menial function positions at MND and its subsidiaries to general positions</li> </ul>
Enforcement Rules of the Military Civilian Personnel Management Act	- Partially amended No. 707 (March 29, 2010)	<ul style="list-style-type: none"> <li>• Overhaul of the performance evaluation system concerning military civilians of Grade-4 or lower (Article 23)</li> <li>• Improve the evaluation system of the result of training and education</li> </ul>
Rules on the Recruitment of Medical/Veterinarian Medical Officers	- Partially amended No. 708 (April 2, 2010)	<ul style="list-style-type: none"> <li>• Require administrator of MMA to inform Defense Minister about list of pre-selected recruits</li> <li>• Set out how to choose successful candidates for medical/veterinarian officers along with criteria for screening candidates</li> <li>• Require candidate selection to include entire document-based and physical exam screening</li> <li>• Mandatory for Medical/veterinarian officers to be hired after completing job orientation training</li> </ul>
Enforcement Rules of the Act on the organization of the DAPA and is subsidiary institutions	- Partially amended No. 709 (April 27, 2010)	<ul style="list-style-type: none"> <li>• The position that can be set aside as open recruitment type is changed from Director General of the Analysis Test &amp; Evaluation Bureau to the Auditor, which is thought to be more relevant</li> </ul>
Enforcement Rules of the Act on Implementation of the Ruling of the Military Court and Treatment of Confines	- Wholly amended No. 710 (May 3, 2010)	<ul style="list-style-type: none"> <li>• Lay out matters entrusted by relevant enforcement decree and measures required for implementation, such as the duties of military correctional officers, criteria for provision of clothes, bedding and food for inmates, religious sessions/educational programs for military prisoners</li> </ul>
Rules on Special Allowance Paid to Uniformed Soldiers	- Partially amended No. 711 (May 13, 2010)	<ul style="list-style-type: none"> <li>• Stipulate raise for military judge advocates agreeing to long-term service</li> <li>• Expand those eligible for payment of additional allowances, such as incentive allowance/air service allowance for uniformed soldiers</li> </ul>
Enforcement Rules of the Act on Prohibition of Unauthorized Use of Military Uniforms and Outfits	- Partially amended No. 713 (June 30, 2010)	<ul style="list-style-type: none"> <li>• Revise handling fee-related provision in connection with abolition of handling fee which used to be collected at the time of receiving or changing a permit for businesses involved with the production and sale of military uniforms and outfits</li> </ul>
Enforcement Rules of the Requisition Act	- Wholly amended No. 714 (July 16, 2010)	<ul style="list-style-type: none"> <li>• Lay out formats related to requisition and compensation for requisition stipulated in Enforcement Decree of the Requisition Act and details of survey of the status of the objects subject to requisition</li> <li>• Stipulate that the loss of, or damage to, the requisitioned objects should be reported</li> </ul>
Enforcement Rules on the Organization of the MND and Its Subsidiary Institutions	- Partially amended No. 715 (July 21, 2010)	<ul style="list-style-type: none"> <li>• Reflect the increase in the number of employees by 13 under the authorized strength for 2010</li> <li>• Increase the number of employees whose employment status was confirmed according to the need of the military for 2010 by 13 in connection with the change in the horizontal and vertical structure of the organization of the MND and its subsidiary institutions</li> <li>• Readjust several functions, including the transfer of the Department of Religion from the Office of National Defense Policy to the Office of Personnel and Welfare</li> </ul>

Name	Serial number of promulgation (date)	Description
Enforcement Rules of the Military Service Act	-Partially amended No. 716 (July 21, 2010)	<ul style="list-style-type: none"> <li>• Overhaul regulations concerning period for permission to travel overseas</li> <li>• Detail regulations pertaining to survey of those listed as being in on-the-ship reserves</li> <li>• Overhaul provision concerning abolition of system for incorporation of those clearly distinguished from others in terms of race and skin color into 2<sup>nd</sup> conscription</li> <li>• Require those listed as disabled to undergo military conscription physical exam</li> </ul>
Wholesale Amendment to the Enforcement Rules of the Veterans' Pension Act	- Partially amended No. 717 (August 12, 2010)	<ul style="list-style-type: none"> <li>• Amend relevant provisions, in line with amendment to the Electronic Government Act, which makes it mandatory to obtain prior consent before any personal information submitted to an administrative institution can be publicly disclosed (this must be confirmed directly by the public official in charge through the network for the joint use of administrative information)</li> </ul>
Enforcement Rules of the Military Civilian Personnel Management Act	-Partially amended No. 718 (August 17, 2010)	<ul style="list-style-type: none"> <li>• Relevant readjustment of military civilian tests in accordance with changes in job groups and job lines and readjustment of test subjects</li> </ul>
Enforcement Rules of the Act on Report and Disclosure of Public Officials' Military Service Records	-Partially amended No. 719 (August 31, 2010)	<ul style="list-style-type: none"> <li>• Simplify wording in forms, including military service records</li> </ul>
Rules on Special Allowance Paid to Uniformed Soldiers	-Partially amended No. 720 (September 16, 2010)	<ul style="list-style-type: none"> <li>• Change description from air service allowance to incentive allowance in regard to fighter, cargo pilot and wing pilot whose total service falls between 16 and 22 years - in connection with amendment to Regulations on Allowance for Public Officials</li> </ul>
Enforcement Rules of the Military Service Act	-Partially amended No. 721 (October 8, 2010)	<ul style="list-style-type: none"> <li>• Change name of public organizations that may use services provided for public service personnel</li> <li>• Adjust length of annual holidays for public service personnel to match those for active-duty enlisted soldiers</li> <li>• Provide basis for Duty Call Revocation Committee in regional Military Manpower Administration offices to screen out those ineligible for replacement service</li> </ul>
Enforcement Rules of the Defense Acquisition Program Act	- Partially amended No. 722 (October 12, 2010)	<ul style="list-style-type: none"> <li>• Overhaul weapons system-related R&amp;D</li> <li>• Implement logistical support for export of defense materiel</li> <li>• Overhaul procedure for consent or permits concerning manufacture, import, transfer, possession, storage and scrapping of military firearms</li> <li>• Set bidding participation time period</li> </ul>
Enforcement Rules of the Organization of the Office of Military Manpower Administration and its affiliated institutions	- Partially amended No. 723 (October 22, 2010)	<ul style="list-style-type: none"> <li>• Transfer publication of annual report on military manpower administration, knowledge management and suggestion system to Regulation Reform &amp; Legal Affairs Division</li> <li>• 24 office employees transfer to menial function positions as working-level manpower resources</li> </ul>
Enforcement Rules of the Organization of the Defense Acquisition Program Administration and Its subsidiary institutions	- Partially amended No. 724 (October 29, 2010)	<ul style="list-style-type: none"> <li>• Place increased manpower in Defense Acquisition Program Administration</li> <li>• Reorganize Cost Accounting Verification Corps and provided basis for changing the status of nine menial function positions to general positions, in step with the amendment to the Defense Acquisition Program Administration</li> </ul>
Enforcement Rules of the Organization of the MND and Its subsidiary institutions	- Partially amended No. 725 (November 8, 2010)	<ul style="list-style-type: none"> <li>• Transfer radioactive ray safety management from Office of Military Force and Resources Management to Office of Personnel and Welfare</li> <li>• Redefine MND general public official positions (Grade-3 or lower) to permit any candidate with proper administrative or technical skills to apply</li> </ul>

# Index

# Index

<b>A</b>			
Abolishment of the Mandatory Residence System for Newly Purchased Private Apartments	240	Cobra Gold exercise	73
Accident Insurance Service	240	Combined Delegated Authority (CODA)	81
Additional Pay-rises Based on Service Period	239	Command Post Exercise (CPX)	191
Ages When Expenditure Is the Highest in the Life Cycle	239	Commercial Vehicle	208
Aegis destroyer	53	Common Operating Environment (COE)	164
Air interdiction operations (AI)	54	Commonwealth of Independent States (CIS)	98
AKJCCS Alliance Korean Joint Command Control System	85	Community Service System	289
Alternative service system	288	Community services	289
Anti-submarine operations	53	Comprehensive Plan to Fully Utilize Civilian Resources	214
Anti-surface ship operations	53	Computer Emergency Response Team (CERT)	164
Arms Control	126	Counselor System for Addressing Female Grievances	174
Article 2.2, The June 4 Agreement	122	Counter Air Operations (CA)	54
Article 5, The National Defense Reform Act	135	CTF-151 (Combined Task Force-151)	111
ASEAN Defense Ministers' Meeting Plus (ADMM-Plus)	94	Currency Reform	25
ASEAN Regional Forum (ARF)	72	CWC: Chemical Weapons Convention	11
Ashena Unit	12		
Asia Security Summit	93	<b>D</b>	
Assessment of impact by gender	174	Daecheong Naval Campaign	26
Assets Operation Guidelines	247	Danbi Unit	12
		December 1 Restrictive Measures	119
		Defense architecture	137
		Defense Budget of China	20
		Defense Cluster Consisting of Industrial, Academic, Research and Military Institutes	215
		Defense Cost-Sharing	88
		Defense Exports Follow-up Logistics Support System	232
		Defense Industry Promotion Funds	230
		Defence Information Resource	158
		Defense Information Technical Standard (DITS)	164
		Defense Informatization Governance	159
		Defense Interoperability Portal System (DIPS)	163
		Defense Technology Information Management Service (DTiMS)	218
		Demilitarization	104
		Deployable Medical System	257
		Depot Maintenance (overhaul/repairs)	209
		Designated ports for inter-Korean navigation route	124
<b>B</b>			
Basic Plan for Military Personnel Welfare	238		
Broadband convergence network bandwidth	162		
Build-Transfer-Lease (BTL)	253		
BWC: Biological Weapons Convention	11		
<b>C</b>			
CBT: Computer Based Training	187		
Character building educational program	183		
Childbirth Encouragement Policy of the MND (applied to multiple-children families)	242		
Civilian Contracted Doctor	256		
Civilian-Military Integrated Welfare Town	243		
Close air support operations (CAS)	54		

Development of ROK-China Relations	93		
Development of ROK-Japan Relations	92	<b>I</b>	
Development of ROK-Russia Relations	94	IAEA: International Atomic Energy Agency	11
Development of ROK-Vietnam Relations	95	Illegal or Unscrupulous Vendors	217
Distance Education	187	IMB: International Maritime Bureau	9
Distributed Denial of Service (DDoS)	70	Improvised Explosive Device (IED)	69
Dongmyeong Unit	12	Incorporation of military units with similar functions	135
		Initial Operational Capability (IOC) verification	82
		Integrated Defense Program Information Management System	218
		Integrated Distance Defense Educational System	188
		Integrated Enterprise Architecture	159
		Integrated Suicide Prevention System	263
		ISAF: International Security Assistance Force	12
		IP: Internet Protocol	162
<b>E</b>		<b>J</b>	
East Asia Strategic Initiative (EASI)	80	Japan –Australia Joint Declaration on Security Cooperation	13
Eight Key Tenets of the National Defense Policy	42	Japan Maritime Self-Defense Force and Escort Flotilla	19
Entrusted area	268	Joint combat development system	50
Exercise	190	Joint Fire Operation System-Korea (JFOS-K)	147
		Joint Tactical Data Link System (JTDLS)	147
		Joint unit	50
		Jointness	50
		JOS: Joint Operation Simulation	192
		JPAC: Joint POW / MIA Accounting Command	300
<b>F</b>		<b>K</b>	
Family Support Service	241	KCTC: Korea Combat Training Center	193
Female Defense Personnel	172	Khann Quest	114
Five Areas where the defense information systems are to be advanced	159	Korea-Central Asia Cooperation Forum	98
Fleet Management System (FMS)	215		
Four Initiatives	160	<b>L</b>	
Four-Point Military Lines	28	Land Partnership Plan (LPP)	87
FPS-5	20	Lease System	208
		Levels of Information System Interoperability (LISI)	163
		Light infantry division	30
<b>G</b>			
Gender recognition	174		
Global Korea	38		
Government-to-Government Sales System (FMS)	232		
GPOI (Global Peace Operation Initiative) Capstone Exercise	115		
<b>H</b>			
HCOC: Hague Code of Conduct Against Ballistic Missile Proliferation	11		

# Index

LIMA Langkawi International Maritime and Aerospace Exhibition	229	NPT: Nuclear Non-Proliferation Treaty	11
		Nunn-Warner Amendment	80
<b>M</b>			
Major points of the Act of Foundation for Defense Informatization and Defense Information Resource Management	158	Open R&D Structure	218
Major points of the regulations pertaining to the recruitment of Managers for the reserve forces	153	Operational Command (OPCOM)	80
Mandatory Reserve System	246	Operational Control (OPCON)	80
Maritime Task Flotilla	142	Opinion Polls	84
Melt-out system	104	Opinion poll about the Bonus Point System for Military Service	250
Military Command	139	Other Accounts	253
Military doctrine	21	<b>O</b>	
Military Executive Agency	135	Paid volunteer system	286
Military Installations Relocation Plan	252	PBL (Performance-Based Logistics)	210
Military Optimum Specialty in Optimal Position	59	Peace Wave	108
Military service evading	289	Policy customer service (PCRM: Policy Customer Relationship Management)	295
Military Structure	138	Practical education	182
Mine operations	53	Precision Replenishment Battalions	150
M-kiss: Military Knowledge-Welfare Integrated Service System	299	Proliferation Security Initiative (PSI)	11
MND-ARMS: Architecture Repository Management System	162	Provincial Reconstruction Team (PRT)	12
Mobilization	59	<b>P</b>	
Mobilization Designation Ratio	150	Paid volunteer system	286
Modeling & Simulation (M&S)	160	PBL (Performance-Based Logistics)	210
MOU on Korea-Philippines Mutual Logistics Cooperation	96	Peace Wave	108
MOU on Korea-Singapore Defense Cooperation	96	Policy customer service (PCRM: Policy Customer Relationship Management)	295
Multiple Launch Rocket System (MLRS)	52	Practical education	182
<b>N</b>			
National Defense Acquisition System	218	Precision Replenishment Battalions	150
National Defense Knowledge Management (e-jisaem)	204	Proliferation Security Initiative (PSI)	11
National Security Strategy (NSS) 2020	21	Provincial Reconstruction Team (PRT)	12
New Strategic Arms Reduction Treaty (New START)	11	<b>R</b>	
Northeast Asia Cooperation Dialogue (NEACD)	100	Real estate in the Mt. Kumgang Tourist Region confiscated or frozen by North Korea.	120
		Remote Maintenance Support	209
		Retirement Age	152
		ROK-Australia Joint Statement on Global and Security Cooperation	96
		ROK-U.S. Military Committee Meeting (MCM)	81
		ROK-U.S. Security Consultative Meeting (SCM)	86
		ROK-U.S. Security Policy Initiatives (SPI)	86
		<b>S</b>	
		Safe Korea Exercise (SKX)	70

SAM-X: Surface to Air Missile	226	The Jeontu 21 Model	194
Scientific Business Management System	218	The Joint Vision for the ROK-U.S. Alliance	78
Scientific Training and Education	185	The May 24 Countermeasures against North Korea	122
Shanghai Cooperation Organization (SCO)	14	The Musudan	35
Shared Data Environment (SHADE)	164	The New Asia Diplomacy	95
Similar Specialty	59	The Onnuri Unit	113
SME-Preferred Item Designation System	231	The Space Basic Act	19
SNS Social Network Service	295	Three exchanges	15
SOFA Status of Forces Agreement	274	Three Management Systems	160
Specialization and Systematization System	219	Time Phased Force Deployment Data (TPFDD)	55
Stabilization Operations Unit	150	TLCM Total Life Cycle Management	210
State properties	283	TOR on the Operation of the ROK-U.S. Combined Implementation Working Group (CIWG)	82
Strategic Alliance towards the 21st Century	40	Training	190
Strategic Arms Reduction Treaty (START- I)	11	Training Range Integration by Area	189
Strategic attack operations (SA)	54		
Strategic Items or Commodities	102		
Switchover service personnel	288	<b>U</b>	
Synthetic Battlefield System (LVC)	186	UN Security Council Resolution 1874	27
<b>T</b>		<b>V</b>	
Tactical Information Communication Network (TICN)	147	Virtualization	162
Tailored and specialized educational courses (2009)	249		
TDF: Tokyo Defense Forum	100	<b>W</b>	
Technology Transfer (spin-on/off/up)	230	WiBro (Wireless Broadband)	163
The Annual Asia-Pacific Chiefs of Defense (CHOD) Conference	72	WMD Weapons of Mass Destruction	8
The Brinkmanship Tactic	27		
The Changjo 21	194	<b>Y</b>	
The Collective Security Treaty Organization (CSTO)	23	Yulgok Project	221
The cross-strait issue	14		
The Hwarang 21 Model	194		
<hr/>			
150-Day Battle and 100-Day Battle	25		
2 <sup>nd</sup> conscription	59		
July 1 Measures	24		

# 2010 DEFENSE WHITE PAPER

---

First edition published on March 31, 2011

Edited by Defense Policy Division, Policy Planning Bureau

Published by Ministry of National Defense, Republic of Korea

---

[www.mnd.go.kr](http://www.mnd.go.kr)

Point of Contact : 02-748-6231~7